



OWNER/OPERATOR'S MANUAL

TRACTOR

4100 Serial # 1001-1501





Orrville, OH

www.ventrac.com

TO THE OWNER

Congratulations on the purchase of a new VENTRAC 4100! The purpose of this manual is to assist you in its safe and effective operation and maintenance.

*With proper usage and care, the **Tractor** will provide many years of service. Please read and understand this manual entirely before using the **Tractor**. Keep this manual on file for future reference.*

Always give Model and Serial # when ordering service parts.

Please fill in the following information for future reference:

Date of Purchase: Month _____ Day _____ Year _____

Model Number: _____

Serial Number: _____

Dealer: _____

Dealer Address: _____

Dealer Phone Number: _____

Dealer FAX Number: _____

Venture Products Inc. reserves the right to make changes in design or specifications without incurring obligation to make like changes on previously manufactured products.

TABLE OF CONTENTS

INTRODUCTION SECTION A

Description	A-1
Specifications	A-2

SAFETY SECTION B

Safety Symbols	B-1
General Safety	B-2
Operating Safety & Procedure	B-3 & 4

OPERATION SECTION C

Front Controls	C-1
High-Low Range	C-2
Rear Controls	C-3
Fenders	C-4
Seat, Seat Belt, Roll Bar	C-5
Battery, Steering Radius, Counter Weights	C-6
PTO Belt Tension Lever	C-7
Front Hitch Lock	C-7
Weight Transfer	C-8
Front Hitch & PTO	C-8
PTO Engagement	C-9
Lights	C-9
Starting Procedure	C-10
Attaching Attachments	C-11
Dual Wheel Mounting (KTA style).	C-12 & 13
Operating on Slopes	C-14

MAINTENANCE & SERVICE SECTION D

Service Schedule	D-1
Engine Oil	D-2
Oil Filter Location	D-2
Air Intake Filter	D-3
Hydrostatic Transmission Oil	D-3
Rear Transaxle	D-4
Hydrostatic Oil Filter	D-4
Fuel Line Filters	D-5
Battery	D-5
Brake Adjustment	D-6
Tire Pressure	D-6
Electrical	D-6

TABLE OF CONTENTS

MAINTENANCE & SERVICE (cont.)

SECTION D

Neutral Adjustment	D-7
Platform Cover	D-8
PTO Belt Change	D-8

WARRANTY

INTRODUCTION

Product Description Ventrac 4100

- The Ventrac Series 4100 is a unique all wheel drive tractor that spreads its weight to four equal-sized flotation tires for excellent power, stability, traction, braking and maneuvering.
- Performance is enhanced by a sturdy articulated chassis frame which oscillates to conform to ground contour and turns with ease via a hydraulic power steering system.
- Hydrostatic transmission drive provides operator choice of speed, direction, attachment lift and auxiliary function (SDLA) through an integrated control system in “arm chair” position. Its position on the right side of the operator is always comfortable and accessible.
- Single high/low range selector lever enables operator to use low range for operating attachments and high range for transport.
- Front-end *Minute Mount* hitch and optional category 1 three-point rear hitch makes the Ventrac 4100 a powerful mate for attachments and the master of many ground maintenance tasks.
- Proper maintenance and safe operation assures long, efficient, and productive performance and provides enjoyment and satisfaction for operator, owner and customers served by this versatile, functional, ingenious all wheel drive machine.



INTRODUCTION

Ventrac 4100 Specifications

ENGINES: **Engine Displacement**

Kawasaki: Gasoline, Model FH721D, 25 hp, 2 Cylinder, Air-Cooled 675 (cc)

Briggs & Stratton: Gasoline, Model 54 31 hp, 2 Cylinder, Air-Cooled. . . . 895 (cc)

Electrical: Kawasaki, 450 cca battery, 20 amp alternator

. Briggs & Stratton, 450 cca battery, 50 amp alternator

Powertrain: Sauer Sundstrand Series 15 Hydraulic pump
Hydraulic Motors connected in series
Two Peerless Series 2600 Dual-Range Transaxles
Oil Cooler
Dual Hydraulic Oil Filters (one 10 and one 25 micron filter)

Tires: Standard Tire: Titan HD 22 x 12 x 8 (21-inch actual diameter)

Optional Bar Tire Carlisle Power TracII 21 x 11 x 8

Optional Turf Tire Carlisle Turf Master 22 x 11 x 10

Dimensions: Wheelbase: 43 inches

Length: 79 inches

Height to Top of Roll Bar: 67 inches*

Width with Single Tires: 48 inches*

Width with Dual Tires: 70 inches*

*Dimensions may vary slightly for each tire option.

Weight: Kawasaki - 1265 lbs.

. Briggs & Stratton - 1290 lbs.

Travel Speed: Standard Tires Low Range: 5.2 mph

High Range: 10 mph

. (speeds vary according to tire size, inflation pressure, and engine RPM's)

Instrument Panel: Tachometer/Hourmeter, Low Oil Indicator,
Voltmeter, PTO Switch & Indicator Light

Roll Bar: Certified R.O.P.S.

Venture Products, Inc. reserves the right to change these specifications without notice.

SAFETY



ATTENTION:

This symbol identifies potential health and safety hazards. It marks safety precautions. Your safety and the safety of others is involved.

SIGNAL WORD DEFINITIONS

⚠ DANGER

Indicates an imminently hazardous situation which, if not avoided, will result in death or serious injury. This signal word is limited to the most extreme cases.

⚠ WARNING

Indicates a potentially hazardous situation which, if not avoided, could result in death or serious injury.

⚠ CAUTION

Indicates a potentially hazardous situation which, if not avoided, may result in minor or moderate injury and/or property damage. It may also be used to alert against unsafe practices.

⚠ WARNING

The engine exhaust from this product contains chemicals known to the State of California to cause cancer, birth defects or other reproductive harm.

CALIFORNIA Proposition 65 Warning

Diesel engine exhaust and some of its constituents are known to the State of California to cause cancer, birth defects or other reproductive harm.

CALIFORNIA PROPOSITION 65 Battery Warning

Battery posts, terminals, and related accessories contain lead and lead compounds, chemicals known to the State of California to cause cancer and reproductive harm.

WASH HANDS AFTER HANDLING!

SAFETY



General Safety Procedures for Ventrac Tractors, Attachments, & Accessories



Read and understand the operator's manual before operating this equipment.

Observe and follow all safety decals.

DO NOT let children or any untrained person operate the tractor or attachment. Make sure that all operators of this equipment are thoroughly trained in using it safely.

Never allow additional riders on the tractor or attachments.

DO NOT operate tractor or attachments if you are under the influence of alcohol, drugs, medication that may impair judgment or cause drowsiness, or if you are not feeling well.

Operate all controls from the operators seat only.

Before operating equipment, make sure all shields are in place and fastened.

Ensure the attachment or accessory is locked or fastened securely to the tractor (power unit) before operating. See tractor manual for locking procedure.

Ensure that all bystanders are clear of the tractor and attachment before operating. Be especially careful and observant if other people are present. Never assume that bystanders will remain where you last saw them.

Always look in the direction the tractor is moving.

Never direct the discharge of any attachment in the direction of people, animals, buildings, vehicles, or objects of value.

Immediately stop at any sign of equipment failure and correct the problem before continuing to operate. An unusual noise can be a warning of equipment failure.

Before adjusting, cleaning, lubricating, or changing parts on the tractor or attachment, engage the parking brake, lower the attachment to the ground, stop the engine, and remove the ignition key.

To prevent the risk of uncontrolled equipment movement on tractors equipped with 2 speed axles, always shift the transaxle range with the power unit stationary on level ground and with the parking brake engaged.

If equipment is to be left unattended, stop the engine, remove the key, and make sure the parking brake is engaged.

SAFETY

Ventrac 4100 Safety Procedures

WARNING

Before making any repairs or adjustments, lower attachment to the ground, set parking brake, shut the engine off, and remove the key.

WARNING

Read and understand the operator's manual before operating this equipment.

Before Operating

- Check engine fluid levels before starting.
- Check brake action before operating and adjust or service as needed.
- Inspect machine before operating. Be sure shields and guards are in good condition and securely in place. Be sure hardware is tight and repair or replace parts that are missing, badly worn or damaged. Check that wheel nuts are tight after first 15-20 hours of operation, and after each time a wheel is removed.

Safe Transport

- When driving on public roads, use a Slow Moving Vehicle sign. Additional flashing warning lights should be installed. Check local traffic laws.
- Be careful around traffic when crossing roadways or operating near them.
- Operate only during daylight or with good artificial light.

Use Extra Care

- Stay alert for holes, hidden objects, and uneven terrain.
- Use extra care when you come to shrubs, trees, or other objects that may block your vision.
- Clear from work area objects that may be thrown.
- If you hit an object, stop machine and check for damage.
- Avoid adverse ground conditions which can limit performance and stability of equipment and could result in serious injury or death.
- Stay **away from** drop-offs.
- **DO NOT** drive where machine could slide or upset.
- Wet grass increases risk of sliding on banks and slopes.
- **DO NOT** try to stabilize the tractor by putting your foot on the ground.
- When pulling loads or using attachments, use only the hitch points provided. Limit loads to those you can safely control.

SAFETY

Slopes

- Use **low range** when on hills and slopes.
- Whenever possible, drive up and down a hill....dual wheels are recommended for mowing across slopes. Be careful when you change direction on a slope. Drive slowly.
- Make allowances in speed selection for hills, slopes, and rough terrain. If the operator becomes uncomfortable or unsure of the unit's stability, the operator should slow down or cease operation.
- When parking, stop the machine on a level surface whenever possible; block tractor tires if it must be parked in a location which is not level.
- Keep fuel level above one-half tank to avoid unplanned engine shutdown.
- **NEVER TURN ENGINE OFF ON A HILL OR SLOPE WITHOUT FIRST MAKING SURE THE PARKING BRAKE WILL HOLD THE TRACTOR IN PLACE.** Before leaving the tractor, ensure that parking brake is set.

Operator Personal Safety

- Be careful around rotating drive lines. Do not wear loose fitting clothes and use appropriate safety equipment.
- Wear earplugs or other protective device when needed.
- **DO NOT** operate tractor if you are under the influence of alcohol or drugs or are not feeling well.
- Engine muffler may be hot; **DO NOT** touch!!
- The Roll Bar is provided for your protection. Always use seat belt with roll bar to minimize chance of injury from an accident. (See "Warning" on C-5 for fold down roll bar exceptions)
- Use caution when handling the battery. Shield eyes as explosive battery gases and acid can cause injury or blindness. Flush eyes immediately with water and seek medical attention. Keep sparks, flames and cigarettes away from battery and fuel tank area.
- Wait for engine and all moving parts to stop before leaving operator's seat.
- Extreme sudden starts or stops can up-end the tractor. **Always use caution** when starting and stopping.

High/Low Shift Lever/Free Wheeling

- **Always make certain that the HIGH-LOW shift lever is completely set into the lock position at the ends of the shift stroke.**
- **Note that freewheeling or neutral occurs in the middle of the shift stroke.**
- Towing is not recommended but in some cases the tractor may need to be pushed a short distance. Place High/Low shifter in freewheel/neutral position. Park brake is functional in freewheeling mode. Park Brake needs to be released if tractor is to be pushed or pulled.
- **Use extreme caution in freewheel/neutral mode. NEVER freewheel on a slope! Never shift the HIGH-LOW lever while moving, unloading, or on a slope. See page C-2 for further instructions.**

OPERATION

The VENTRAC 4100 is an innovative all-wheel drive, Compact Articulated Tractor (CAT) (**Figure 1**). Its innovative design offers many advantages and some variables from conventional compact utility tractors. The differences make it VERY important for the operator to read and understand this operational manual in order to facilitate safe, enjoyable and effective operation of the VENTRAC 4100!



Figure 1

The first sight of the VENTRAC 4100 reveals its low profile, four (4) identical drive tires and the articulated frame. Less obvious is the easy-to-use *Minute Mount* Front Hitch and PTO drive that makes frequent use of many different attachments a breeze!

The tractor is designed with a low bi-level foot platform, and openness between dash and fenders to make entering and exiting easy for the operator from either side; however, right side entering and exiting is somewhat restricted by the control levers. Always put the Control Selector (**Figure 2**) DOWN in PARK BRAKE position before leaving the tractor seat. This assures the neutral locking of the directional control and park brake engagement.



Figure 2

FRONT CONTROLS

Most controls and gauges are directly in front of the operator (**Figure 3**). Decals reveal their position, function and motion.



Figure 3

OPERATION

The dash shows IMPORTANT operational and safety instructions. A manual choke pull is located in the right lower corner for gasoline engine models. Just below the dash on the right side is a three- (3) position **Control Selector (Figure 4)**.

1. DOWN – activates the park and emergency brake. ALWAYS return lever to this position when the tractor is not in use. The lever must be in this position to START the engine.

2. LEVEL – causes the directional control lever beside the operator to have a **spring-assist-to-neutral** action. This position makes neutral easy to find and maintain. If the tractor creeps when in neutral, see “Neutral Adjustment” (Figure 50).

3. UP – puts the directional control lever beside the operator into easy shift mode. This position is recommended only for open area operation where travel speed and direction is relatively constant and control is very easy to maintain. Easy shift mode reduces operator arm fatigue.

(see Figure 49 for 3 position decal)



Figure 4

HIGH-LOW RANGE

HIGH-LOW transaxle shift lever (Shown in Figure 5). Forward is LOW range. Back is HIGH range. **NEVER SHIFT WHILE UNDER LOAD, MOVING, OR ON A SLOPE!** The shift lever shifts both transaxles simultaneously. Sometimes engagement of the transaxle gears is prevented by gear misalignment. Moving the S.D.L.A lever slightly one way or the other will move gears enough to complete the engagement. **Always make certain that the HIGH-LOW shift lever is completely set into the lock position at the ends of the shift stroke.**

Note that freewheeling occurs in the middle of the shift stroke. Towing is not recommended but in some cases the tractor may need to be pushed a short distance. Park brake is functional in freewheeling mode. **Use extreme caution in freewheel/neutral mode. Never freewheel on a slope!** (See “Safety” on page B4)



Figure 5

NOTE:

- Low range is recommended for most pulling, pushing, and slow travel.
- High range is for transport and light duty tasks.

OPERATION

REAR CONTROLS

S.D.L.A. System—Speed, direction, lift, auxiliary

The primary lever with the large round knob (See Figure 6) is the directional control (sometimes called the Forward/Reverse lever, F/R). It has two distinct functions:

I.) Operator must be seated to release the seat safety latch. Forward movement from the neutral position will cause the tractor to move forward. The farther the lever is moved, the faster the tractor will travel. Returning toward the neutral position will slow the tractor and in neutral it will stop. Note that the directional lever operates the same for reverse and always works equally well for starting and **STOPPING!** This **shift-on-the-go** feature with engine power and brake power to all four tires makes the VENTRAC 4100 an amazing performer in many situations. Yet extreme caution is important to avoid unexpected and difficult situations that could cause serious injury or damage to operator or equipment. (See safety section)

II.) The second function of the primary lever controls the hydraulic front hitch. Pulling the lever to the left toward the operator raises the hitch. Moving it to the first position to the right is to lower front hitch with down pressure. Second position to the right is a locking detent to engage float of the front hitch. **Always use the float position for mowing and other tasks where flotation of the attachments is desired or necessary.**

Directly behind the primary lever is a smaller lever (**Figure 7**) that controls the auxiliary hydraulic circuit. This lever activates attachments with functions that use hydraulic hoses connected to the front quick couplers. Move the lever left or right to activate the auxiliary circuit.

NOTE: A float kit for auxiliary function is available. See your dealer for this option.

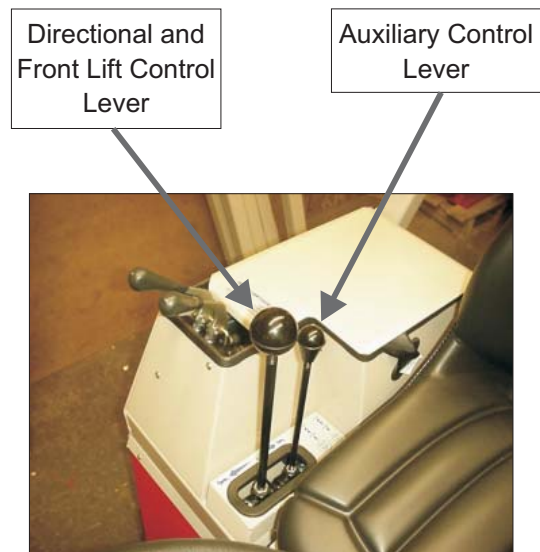

Figure 6 & 7

OPERATION

FENDERS

The right fender serves as a storage box. The cover opens outward. Operator should always close the cover before operating the tractor. Tractors with the 3-point hitch option have a modified cover and use the front part of the storage box for the hydraulic valve and hoses (See 3-point hitch section).

The VENTRAC 4100 operator's manual is stored in a holder inside the storage box (**Figure 8**). It should be kept in a plastic cover for protection and always be readily available to any and all operators. Attachment manuals should also be stored in the holder. If a manual is missing, contact the dealer for replacement.



Figure 8

The left fender houses the 7.25 gallon fuel tank. **Always note the type of fuel: Unleaded Gasoline (Figure 9)**. If decal is missing or unreadable, contact your dealer for a replacement decal. Determine fuel type before ordering. **Never over-fill!** Stop before fuel spills over the fill opening.



Figure 9

⚠ WARNING

Never remove gas cap or add fuel while engine is running.
Allow engine to cool before refueling.
Never refuel or drain the system indoors.
Use only an approved container.
Do not smoke near fuel tanks.

A long slot in the left fender at the front inside corner serves as a fuel gauge (**Figure 10**). Always keep sufficient fuel in the tank to prevent an unexpected engine shut-off. When operating on slopes, fuel level should be kept at least half full.

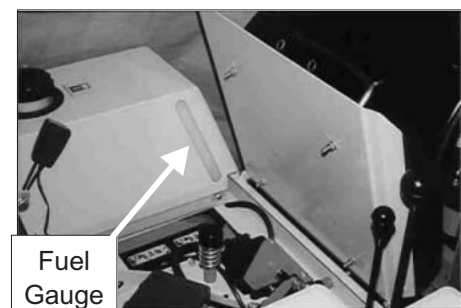

Figure 10

OPERATION

SEAT

The VENTRAC 4100 has an adjustable seat — forward and back. Each operator should adjust the seat for the greatest control and comfort in relation to the steering wheel as well as the directional control lever (**Figure 11**). The seat can also be tilted up during nonuse for access underneath (**Figure 12**) or for keeping the seat dry in inclement weather.



Seat Adjustment
Lever

Figure 11



Figure 12

⚠ WARNING

- If tractor is equipped with a fold down roll bar, always operate in upright position whenever possible. Lower roll bar only when absolutely necessary to do a task, and return to upright position as soon as task is completed.
- **Note:** When in lowered position, do not use seat belt.

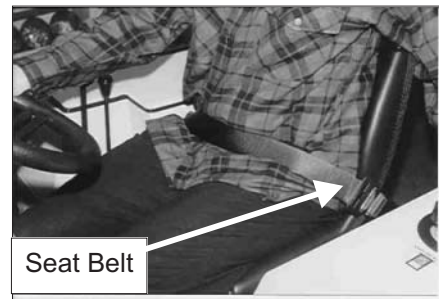

Seat Belt

Figure 13

SEAT BELT/ROLL BAR

Certified seat belt anchor—**#OSHA 1928.51**

Certified R.O.P.S. roll bar—**#OSHA 1928.52**

Always use the seat belt (**Figure 13**) with the roll bar. Operator must be seated to activate the front PTO. They are there for your protection!

The roll bar (**Figure 14**) is mounted with four 3/8 x 1— grade 5 hex bolts with 3/8 SF nuts on each side. (Torque to 30 FT/LBS.)

Note: Roll bar mounting flange is on the inside of fender panel. All VENTRAC 4100s are shipped with roll bar and hardware. Roll bar maybe furnished unmounted for shipping convenience.

Roll bar must be installed before operating tractor!



Upright
position
shown

Figure 14

OPERATION

BATTERY

The battery is located under the seat. Tilting the seat forward gives access to the top of the battery. **Before using jumper cables or connecting a battery charger, always check polarity (Figure 15).** The RED cover means POSITIVE. The BLACK cover means NEGATIVE. The negative wire should always be connected to ground (the frame)!



Figure 15

STEERING RADIUS

The steering radius can be adjusted to three different settings (Figure 16). Note the three positions under the left front corner of the foot platform. Factory setting uses the inside hole. Dual wheels require the middle hole. The weather cab and loader require the outside hole setting. The outer settings reduce the turning radius. This prevents tire and frame interference.

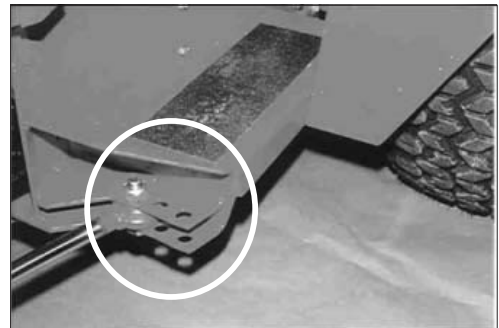

Figure 16

OPTIONAL COUNTER WEIGHTS

Up to four 42 pound counter weights can be added as optional equipment on the VENTRAC 4100. The weights are mounted close-in as shown in (Figure 17) with retainer pin and clip. Counter weights improve stability and traction with front mount attachments.



Figure 17

OPERATION

RIGHT SIDE CONTROLS

At the right side of the operator and below the dash, is the PTO belt tension lever, the front hitch lock, and one weight transfer adjustment chain.

PTO BELT TENSION LEVER

The lever located on the side of the center column is the PTO belt tension lever (**Figure 18-A**). Raising the belt tension lever to the up position tightens the belt for implement operation. Lowering the belt tension lever to the down position releases the belt tension (**Figure 19-A**) allowing the operator to remove or install the PTO belt at the front of the tractor. **This procedure should be done only with the engine shut-off and the park brake engaged.**

MINUTE MOUNT FRONT HITCH LOCK

On the far right is the lever that locks and releases the attachment from the front hitch of the tractor. The stroke length is approximately 10". Up is "open" (**Figure 19-C**) and down is "lock" (**Figure 18-C**). Make certain that the lever is secured in the notch when in the down position. Note: The attachment must be fully engaged before the "lock" position can be secured.

The hitch lock lever has a safety latch (**Figure 18-D**) to prevent accidental release of the front hitch from the attachment. To release the hitch lock lever, lift up on the safety latch.

OPTIONAL WEIGHT TRANSFER

(See page C-8)

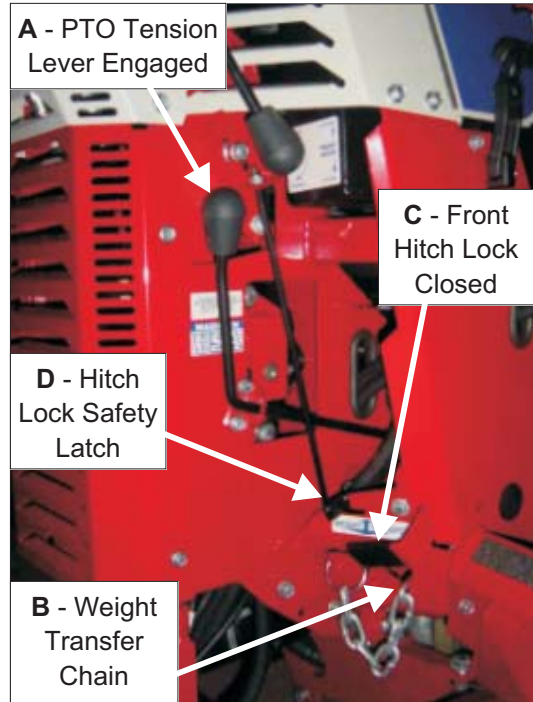

Figure 18

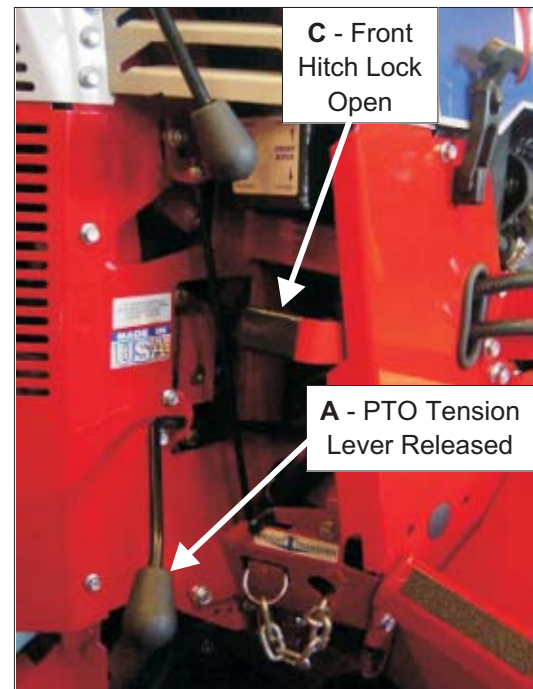

Figure 19

OPERATION

OPTIONAL WEIGHT TRANSFER

The Ventrac integrated "weight transfer system" is designed to transfer some of the front attachment weight onto the tractor. Advantages of this system are: increased traction to the drive wheels, increased lifting capacity and it allows the attachment to float over the surface contours with less weight in contact with the ground. This is a valuable feature when using the mower, snow thrower, slip scoop, leaf blower and other attachments.

On the lower right hand side of the dash is a weight transfer chain (**See pg. C-7, Figure 18-B**). This chain engages or disengages the right extension spring. There is a corresponding weight transfer chain on the left side. This adjusts the left weight transfer spring. Note: The more chain that is outside the "keyhole" the greater the amount of weight that is transferred. Hitch should be lifted to the highest position to change settings.

The amount of weight to be transferred is the operators preference. Normally it is set to the maximum amount possible without effecting the performance of the attachment. Examples of this are: The HM720 mower can use full weight transfer, but on the HM600 this can make the mower light enough that it won't always stay in contact with the ground in undulating areas. If full weight transfer is used on the leaf blower it will not go down when the front lift is put in the float position, use just enough to allow the blower to make contact with the ground when in float. Using full weight transfer with the HE480 scoop will increase the lifting capacity, but down pressure will be required to lower the scoop to the ground.

FRONT HITCH & PTO

The two rail, *Minute Mount* Front Hitch, (**Figure 20**) is the secret of stable, secure and safe mounting of attachments to the all-wheel-drive VENTRAC 4100! Just align the two rails to the two corresponding hitch arms on the attachment. Raise or lower the tractor hitch for the initial contact with the attachment arm tabs. Lift the tractor hitch to an in-line relationship and complete the engagement. Engage the *Minute Mount* hitch locking lever to the "Lower" position. To release lift the lever to the high position. (**See pg. C-7, Figures 18 & 19**)

Attachments that require the use of a PTO belt must have the PTO belt installed over the left hitch arm before engaging the tractor to the attachment arms (**Figure 21**). Generally this happens naturally because the attachment pulley and guard hold the belt in place. After the hitch locking lever has been "locked," with engine stopped, simply install the PTO belt over the outside groove of the PTO idler pulley (**See Figure 20**) and engage the PTO belt tension lever. (**See pg. C-7, Figures 18 & 19**)



Figure 20

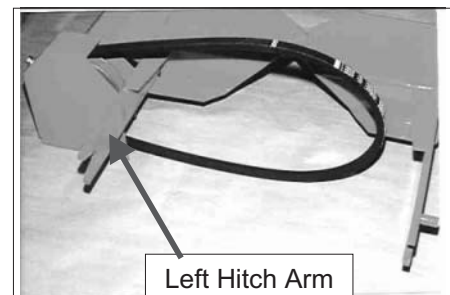

Figure 21

OPERATION

AUXILIARY HYDRAULIC HOSES

For attachments that require the front auxiliary hydraulics, install the hoses up through the hose retainer rod and onto the quick couplers on the tractor (**Figure 21B**). This will keep the hoses from contacting the tire.

Note:

When removing the hoses from the tractor quick couplers, always reinsert dust caps into quick couplers.

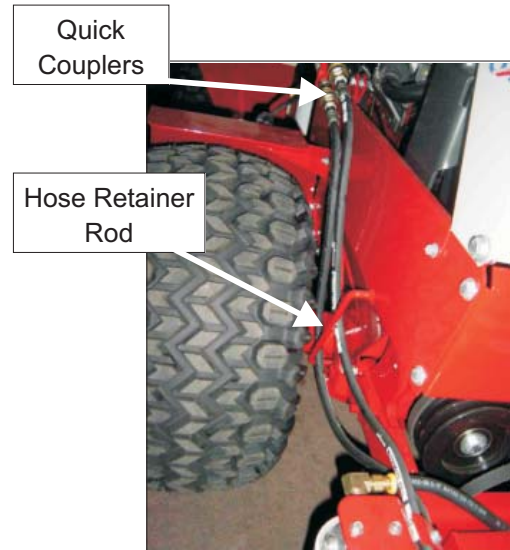

Figure 21B

LIGHTS

(**Figure 22**)

Headlights and taillights improve safety and operational visibility. Their use is highly recommended especially at dawn or dusk and at night. The headlights can be adjusted to the operator's preference by loosening the mounting bolt directly under each light fixture. The fixture can be moved so that the light beam moves up or down, right or left. Once in the desired position, retighten the mounting bolt.



Figure 22

PTO* ENGAGEMENT

When engaging power to the front attachment, it is necessary for the operator to be seated. Check that all is clear and safe for operation, before engaging the PTO switch (**Figure 23**). When the PTO switch is engaged, a PTO operation light will come on. When the engine is cold, stalling is possible at the moment of engagement. Increase the engine RPM's and/or increase the warm-up time and repeat engaging PTO switch. An integral brake system stops the PTO within 7 seconds when the switch is moved to OFF or the operator leaves the seat.

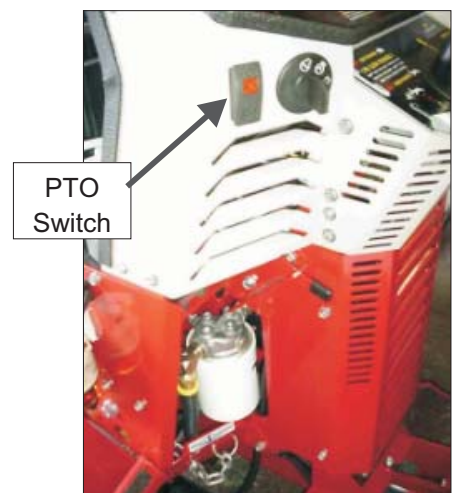

Figure 23

*Power Take Off

OPERATION

STARTING PROCEDURE

1. Check engine oil and fuel levels.
2. Read “CAUTION” and instructions on dash.
3. Operator should be sitting on the seat.
4. Fasten seat belt.
5. Make sure the tractor is in park. **(Figure 24)**
6. Throttle should be at or near idle. (Choke as needed, engines vary.) **(Figure 24)**
7. Turn the key clockwise **(Figure 25)** until the engine starts.
8. Once the tractor is started, let the engine and transmission system warm up a minute or two. Always check to see if the steering system is responsive before attempting to drive the tractor. This assures that the hydraulic system is fully charged. In cold weather conditions, increase the warm-up period to 3 or 4

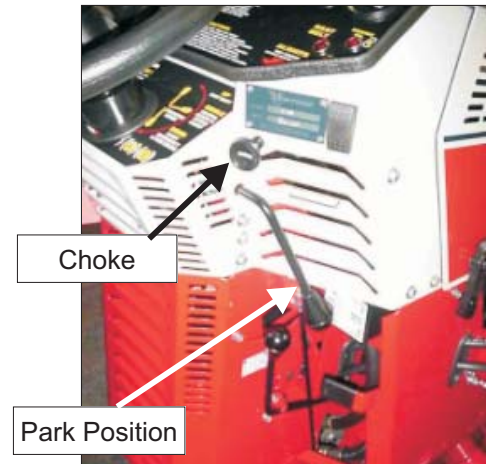

Figure 24



Figure 25

OPERATION

ATTACHING ATTACHMENTS

Most front mounted Ventrac attachments can be positioned so that it is convenient to drive into the hitch arms with nearly correct alignment (**Figure 26 & 27**). Slight adjustment may be required to complete the hitch engagement.

When completely engaged, move the *Minute Mount* lever to “latched” position. If lever will not move into “latched” position, check the attachment for complete engagement.

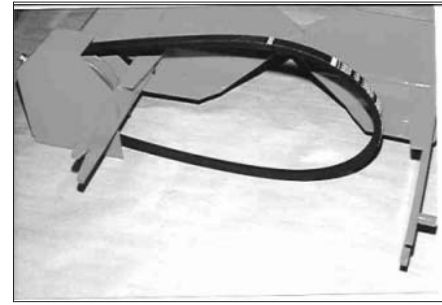

Figure 26

⚠ WARNING

Before making any repairs or adjustments, lower attachment to the ground, set parking brake, shut the engine off, and remove the key.

1. **Shut off the engine and engage the parking brake.**
2. Walk to the front of the mower and push it into the tractor as far as the hitch will allow. Make sure both sides are against the stop.
3. Place the mower PTO belt over the outside groove of the idler pulley.
4. Return to the tractor seat. Engage the *Minute Mount* lever into the “latched” position and rotate the PTO tension lever up into the “engaged” position.



Figure 27

Note:

1. Mower attachments have a floating hitch (**Figure 26 & 27**). If mower cutting height is set near the highest position, the tractor can be driven into the hitch arm. Then raise the hitch until the mating arms are parallel. Complete the engagement.
2. Attachment changes are made easier and safer by using level, clean surfaces.
3. Heavy duty, close tolerance latch hooks (**Figure 28**) make complete engagement of attachment hitch necessary on both sides before *Minute Mount* lock lever can be activated. The result is a strong, well fitted connection for optimum control and performance.

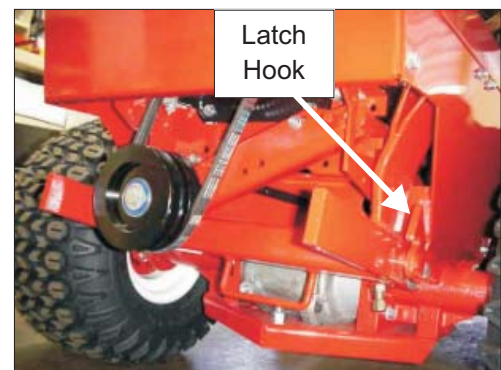

Figure 28

OPERATION

DUAL WHEEL MOUNTING/OPERATION KTA (LATE) STYLE

Dual wheels are an available option for the VENTRAC 4100. (Heavy Axles are required. All 4100's serial #'s ---1091 and above come standard with Heavy axles. Serial #'s ---1090 and below must have optional Heavy axle kit 70.0096.) They are useful for increasing stability on slopes and to reduce soil compaction. Once the dual mounting hubs have been installed in each wheel, the dual wheels can be mounted and dismounted quickly by the center draw bolt. Dual wheels can be used on any or all four wheels. Keeping the center draw bolt tight, the inflation pressure of the outside mounted tire to a max of 4 psi, and operating the Ventrac gently are all important for successful, safe, and continuous performance of the dual wheels.

Dual wheels are recommended for sandy soils or where a broad distribution of tractor weight is desired, including operating sideways on slopes greater than 20 degrees. Dual wheels are only one of numerous considerations for safety on slopes. Speed, terrain, irregularities, and even the potential for equipment stoppage are serious factors to consider for safe operation of the tractor.

INITIAL MOUNTING INSTRUCTIONS

Note: Prior to Serial Number ---1095, begin with step 1. Starting with Serial Number ---1095, the 7/16 x 2-1/2" bolts are standard on the tractor, skip to step 2.

1. Raise up the tractor and remove the existing wheel. Drive out the five stud bolts from the hub (See C-13, Ref 2) and replace with provided stud bolts (7/16" X 2-1/2") from the kit.
2. Remount wheel using the original lug nuts.
3. Install inner dual mount (See C-13, Ref 6) (**Figure 31A**) with the standard 7/16" SAE nuts and tighten.
4. Mount dual wheel to the dual extension (See C-13, Ref 8) (**Figure 32A**) with lugs nuts from the kit.

Note: tighten all nuts to approximately 55 ft. Lbs.

5. Make certain the wheel extension is assembled per the drawing. Draw bolt (See C-13, Ref 10) with flat washer is inserted through the extension and threaded into the draw cone (See C-13, Ref 7).

Note: the pin on the draw cone must be turned toward the draw bolt head.



Figure 31A



Figure 32A

OPERATION

Dual Mounting Instructions (Cont.)

To install wheel assembly:

Raise tractor up approximately 2" by driving on planks or using a jack. Insert threaded end of dual assembly into the inner wheel mount, turn wheel clockwise until the wheel is hand tight. Using a 1" socket, torque draw bolt to 120 ft. Lbs.

To remove wheel assembly:

Loosen draw bolt (See C-13, Ref 10) approximately 5 turns and hit the end of the draw bolt sharply with a medium size hammer. This will loosen the draw cone and allow removal of the dual assembly by turning counter clockwise.

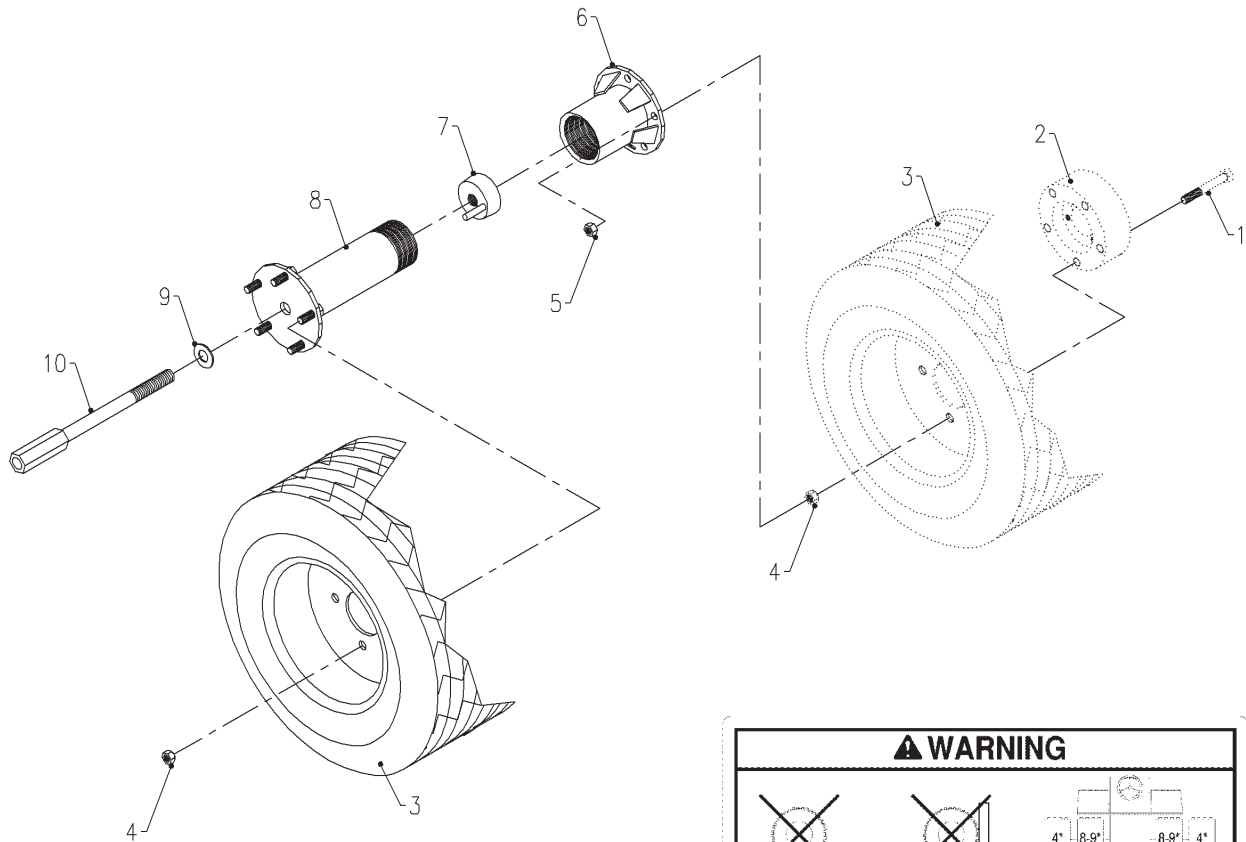

⚠ WARNING			
4* PSI	8-9* PSI	8-9* PSI	4* PSI
- OPERATION WITH DUAL WHEELS REQUIRES INSIDE TIRE PRESSURE OF 8-9* PSI AND OUTSIDE TIRE PRESSURE OF 4* PSI MAX.			
* TURFMASTER TIRES REQUIRE INSIDE TIRE PRESSURE OF 15 PSI AND OUTSIDE TIRE PRESSURE OF 10 PSI MAX.			
- OVER INFLATION OF EITHER TIRE MAY RESULT IN DAMAGE TO THE TRACTOR AND/OR OPERATOR			
- AVOID RUNNING INTO SOLID OBJECTS WITH WHEELS			
- CROSS CURBS OR SURFACE OFFSETS AT SLOW SPEED			
- DO NOT OPERATE IN DITCHES OR ALONG CURBS WHERE THE OUTSIDE DUAL CARRIES MOST OF THE WEIGHT			
- EXCEEDING THESE RECOMMENDATIONS MAY VOID WARRANTY			

00.0202

OPERATION

OPERATING ON SLOPES

Operation on slopes decreases tractor stability and increases the possibility for unexpected difficulties. Only experienced VENTRAC 4100 operators should operate the tractor on slopes and extra caution should be used that includes: **(See drawings at right.)**

1. avoiding uneven, loose, or wet terrain.
2. staying clear of drop-offs, holes, ditches, rocks, or objects that could cause a sudden and/or unexpected force on the tractor.
3. using low range and slow speed. Use sufficient engine rpms. to prevent engine stall.
4. using sufficient fuel in tank to assure continuous operation.
5. making slow and cautious starts, stops, and turns.
6. using the weight transfer system with attachments.
7. avoid unnecessary and sudden changes in speed and direction.
8. using dual wheels when traveling across slopes of more than 20 degrees.
9. ceasing operation if tractor instability is suspected or evident, or if the operator is uncomfortable or unsure of continuing safe operation.

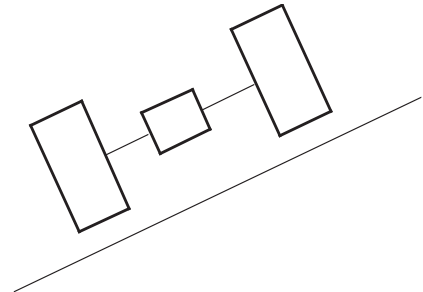

**20 degrees max.
Without Dual Wheels**

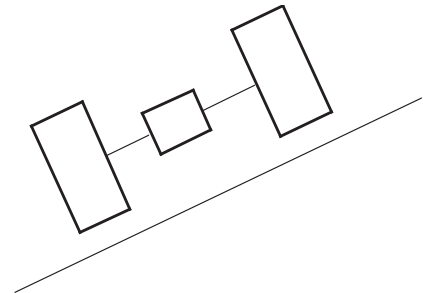

**25 degrees max.
With 3" Wheel Extensions**

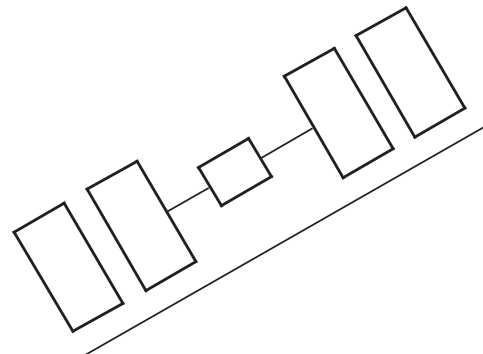

**30 degrees max.
With Dual Wheels**

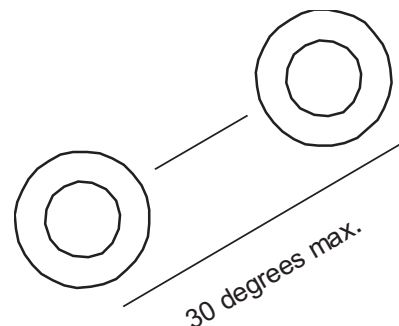

30 degrees max.

⚠ WARNING

- Keep engine oil level near full mark and the fuel tank should be at least half full when operating on slopes.
- Engines are designed for continuous operation at 25 degrees or less.
- Intermittent operation is required for slopes of 25-30 degrees. Operate for a maximum of ten minutes, before bringing tractor to level ground, and then return to slope for another ten minutes.
- The ultimate responsibility for safe operation on slopes is the responsibility of the operator!

IF IN DOUBT...DON'T!!

SERVICE & MAINTENANCE

The operator's manual and decals should be read and understood before operating the tractor, attachments, or implements. This manual should be reviewed periodically or when in doubt about any function, procedure, or safety factor on this equipment.

Daily

Check the oil level daily in the engine. Fuel level needs to be checked every couple hours. Air intake filter should be checked daily when operating in dirty conditions. Change when needed. Keep equipment clean. Accumulated debris can restrict performance, cause equipment failure and be a safety hazard. Check for loose or worn parts and oil leaks. Check tire pressure.

Lubrication

Grease the center pivot and the front hitch pivot at the grease zerks at engine oil and filter change. Grease fittings on lift and steering cylinders, if a fitting is provided.

Engine Oil and Filters

25 hp Kawasaki — Refer to engine owner manual for maintenance schedule.

31 hp Briggs & Stratton — Refer to engine owner manual for maintenance schedule.

Transaxle Oil and Filters

Change oil filters only if there is a noticeable loss of power steering (assuming proper oil level has been maintained). Change oil and oil filters only if the system has been contaminated. Check oil levels every 250 hours in rear transaxle— every 50 hours in front axle top reservoir. If there is an oil leak or new attachments have been used that require “priming”, the front transaxle oil level should be checked at that time. **(Refer to page D-3, Figure 37)**

Hydrostatic System

This tractor is equipped with a high-efficiency closed-loop hydrostatic drive system. Repair or replacement of all components in this system including the **hydraulic pump**, **both hydraulic motors**, and the **1/2” hydraulic hoses** connecting them together require special repair procedures and should only be performed by an authorized Ventrac dealer or service technician. Failure to follow these repair & replacement procedures may cause severe damage and may void all warranty to the hydrostatic system.

WARNING

Before making any repairs or adjustments, lower attachment to the ground, set parking brake, shut the engine off, and remove the key.

SERVICE & MAINTENANCE

Each day's operation of the tractor should begin with an oil and fuel check.

See engine manual for oil specifications.

ENGINE OIL

Each engine is equipped with a dipstick to check the crankcase oil level. Check the engine manual for specific instruction about the engine. Oil level should be in the range between the high and low mark. If working the tractor on slopes, oil level should be kept near the full mark. The capacities and filter part numbers are shown in the chart to the right (Figure 33). Regular and proper maintenance will greatly extend the life and performance of the engine.

Changing oil—The engine crankcase oil drain is located a few inches ahead of the left front axle housing and about 2" under the side frame for the 25 hp Kawasaki (**Figure 34A**), or a few inches ahead of the right front axle housing for the 31 hp Briggs & Stratton (**Figure 34B**). It requires an 11/16" wrench. Oil stream will be directed nearly straight down.

When operating 31 hp Briggs & Stratton in ambient temperatures of 90 F or greater, a synthetic engine oil is recommended. Use of a synthetic oil does not alter the engine manufacturers recommended change intervals.

Refer to engine manual for recommended oil specifications.

	Kawasaki	Briggs & Stratton
Capacity	2.1 qts.	2.5 qts.
Filter #	13.0063	13.842921

Figure 33



Figure 34A

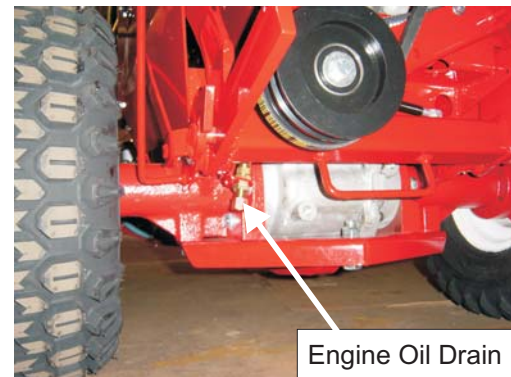

Figure 34B

OIL FILTER LOCATION

All VENTRAC 4100's come equipped with an oil filter relocater (**Figure 35**). This allows for front lift clearance. The filter is located in front of the engine on the left side of the tractor.



Figure 35

SERVICE & MAINTENANCE

AIR INTAKE FILTER

Kawasaki engine air intake filters are located above the engine and have a prefilter band over a paper element. **(Figure 36A)** The paper element should be changed if its appearance is dirty or light is no longer visible through the element when held up to a light source. See engine manual for more details.

Note: Kawasaki does not recommend oiling the foam prefilter (outer) element.

The Briggs & Stratton engine air intake canister filter is mounted above the rear of the engine. **(Figure 36B)**

Note: Refer to engine owner manual for recommended procedures for servicing engine air filter.

- If engine is operated in dusty conditions, it is necessary to service the air filter more frequently.



Figure 36A



Figure 36B

HYDROSTATIC TRANSMISSION OIL

The top oil reservoir for the hydrostatic transmission oil is located under the hood near the right side of the dash. Check oil level when oil is cold. Find the oil level in the plastic sight tube next to the expansion tank, and check that it is within the proper range indicated by the oil level decal. This is important for proper performance and life of the hydrostatic system. **NOTE: Non-compliance to this specification may void the VENTRAC 4100 warranty.**

Note: Generally the hydrostatic oil level remains constant except when:

- 1) New attachments are added that use the auxiliary oil circuit.
- 2) There is an oil leak.

NOTE: Changing of hydrostatic oil is **Not** recommended except in the event of excessive contamination.

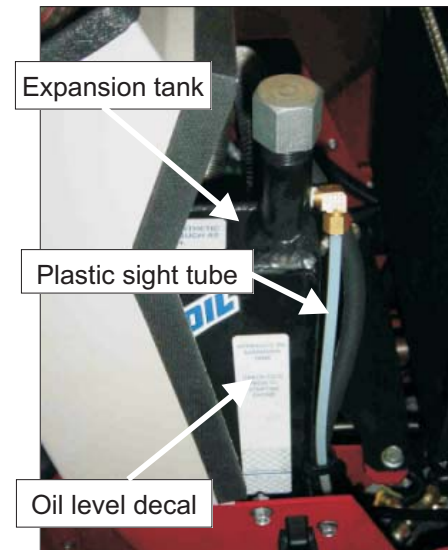

Figure 37

REQUIRED OIL SPECIFICATION
Ventrac Hydro•Torq XL synthetic hydraulic oil
System Capacity: Front - 12 quarts Rear - 4 quarts

SERVICE & MAINTENANCE

REAR TRANSAXLE

The rear transaxle oil is captive and remains constant unless there is a leak. For convenience, the same oil is recommended that is used in the front transaxle. Oil can be added through the plug from the rear (**Figure 38**). It is located above the rear hitch and slightly to the left. To check the oil level on a level surface, remove the oil fill plug in the transaxle (**Figure 38**), and check to see if oil level is even with the bottom of oil fill hole. If no rear transaxle leaks are observed, this level should be checked every 250 hours or annually.

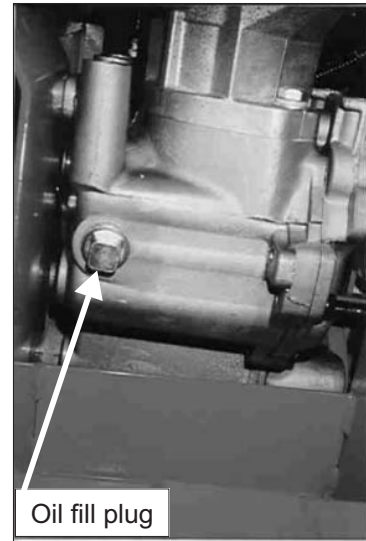

Figure 38

HYDROSTATIC OIL FILTERS

Two filters protect the hydrostatic transmission system.

1) A 25-micron (suction) non-bypass filter located above the operator's left foot on the front frame of the tractor (**Figure 40**). Part # 21.0001

2) A 10-micron (pressure) non-bypass filter located behind the right foot of the operator on the rear frame of the tractor (**Figure 41**). Part # 21.0078

These filters do not need to be changed unless the system is contaminated or the operator experiences noticeable loss of steering even when the hydrostatic oil level is properly maintained. If this symptom occurs, change both filters.

Replacement of oil filters may create some oil spill. A shallow pan or towel can be helpful in containing the oil spill.



Figure 40

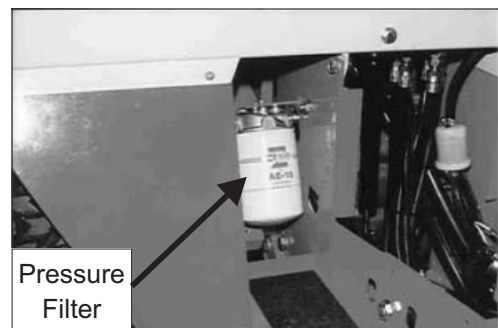

Figure 41

SERVICE & MAINTENANCE

FUEL LINE FILTER (S)

IN-LINE FUEL FILTER

VENTRAC 4100's have an in-line fuel filter located near the engine on the right side (**Figure 42A - Kawasaki**) or inside the foot platform cover (**Figure 42B - Briggs & Stratton**).

Always use clean, fresh fuel. Keep the fill area clean and the fuel cap in place except for filling. If or when any of the above conditions are not met or the engine lacks power, especially under load, the fuel filter should be checked. If the in-line filter needs to be replaced, be sure to install the new one with the flow arrow pointing toward the engine.

PART NUMBER	ENGINE
13.0131	Kawasaki
13.0134	Briggs & Stratton



Figure 42A



Figure 42B

BATTERY

When it is necessary to remove and/or replace the battery, remove the negative battery cable and then the positive battery cable. Then remove the bracket (**Figure 45**) near the left side of the foot platform and slide the battery forward and out. To install the new battery, repeat the above instructions in reverse. Be sure the new battery has the same dimensions, has top terminals, and is installed with the terminals on the side toward the center of the tractor.

⚠ CAUTION

Negative cable (black) should be removed first and installed last.

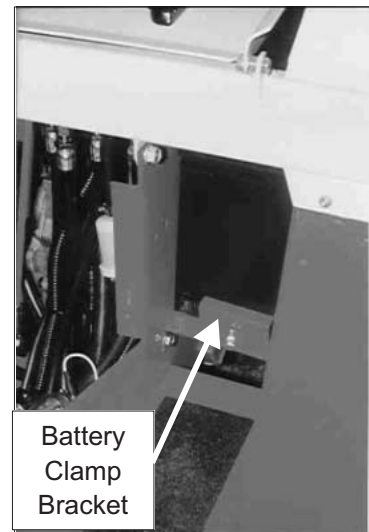

Figure 45

SERVICE & MAINTENANCE

BRAKE ADJUSTMENT

A 6" diameter brake band is activated by the 3-position control selector. The brake holds only when the lever is in the **down** position. If brake is not holding sufficiently, tighten the 1/4" nut on the brake linkage, located on the right side, just below the dash (**Figure 46**). Turn the lock nut clockwise several turns. Check if sufficient pressure is applied for brake to hold. Adjust lock nut until the brake hold is firm. If the brake adjustment is too tight, it will be difficult to engage the control selector into the park position.



Figure 46

TIRE PRESSURE

RECOMMENDED TIRE PRESSURES FOR VENTRAC 4000 SERIES TRACTORS				
Tire	Single Wheel	Dual Wheels		With Loader or Heavy Lifting (Single Wheels Only)
		Inner	Outer	
Field Trax	8-9 psi	8-9	4 Max	15 psi
Bar Tires	8-9 psi	8-9	4 Max	15 psi
Turf Trax (discontinued 04/05)	8-9 psi	8-9	4 Max	Not Recommended*
Turf Master	15 psi	15	10 Max	20 psi

*Turf Trax are not recommended for use with the loader or inflation to exceed 10 psi.

ELECTRICAL

Fuses and relays are conveniently located just under the dash and accessible with the hood open (**Figure 48**).

See wiring diagram. (**Section B of Parts Manual**)

NOTE: There is an inline fuse located at the starter.

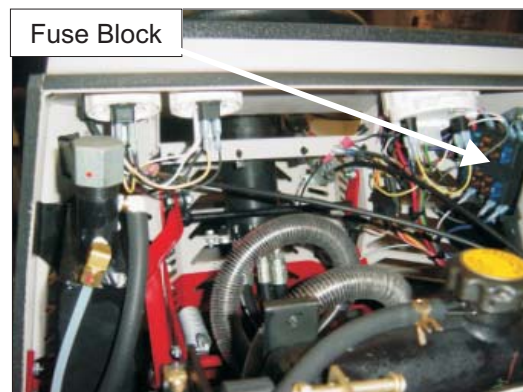

Figure 48

SERVICE & MAINTENANCE

NEUTRAL ADJUSTMENT

The tractor should always come to a complete stop when the **Control Selector** is in the “**park brake**” position (down) or the “**neutral detent & spring assist**” position (level) when the Directional Control lever is in neutral. If the tractor consistently wants to creep while in neutral, an adjustment must be made to the neutral device.

Jack tractor up and secure with jackstands or blocks.

Place the selector control in the level, “spring assist to neutral” position (**Figure 49**). Located on the bottom right side of the steering column is a bolt (5/16) located in a slot (**Figure 50**). Loosen the nut just enough to free the grip of the bolt from the slot. Move the bolt slightly in either direction until the tendency to creep stops. Retighten the bolt.

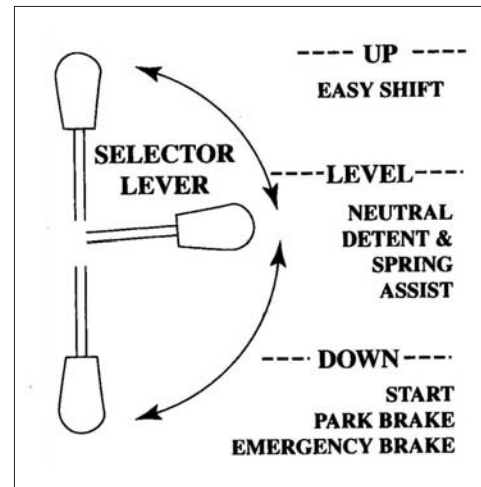

Figure 49

CAUTION

Caution should be used when making this adjustment. During the correction process, the tendency to creep can be increased and the tractor could actually begin to move.

To prevent this possibility, jack up the right front and right rear of the tractor so the tires are off the ground.

This has two advantages: 1) SAFETY, because the tractor has no traction to move and 2) neutral can easily be determined when tire rotation stops.

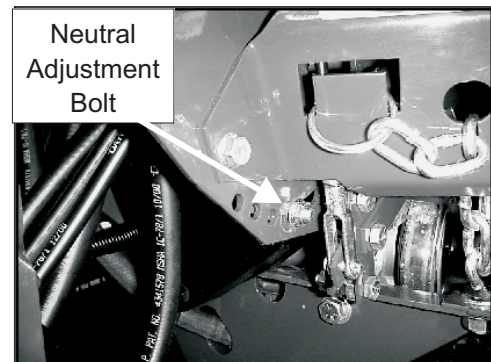

Figure 50

NOTE: The neutral adjustment procedure is recommended with the engine running around **2000 RPMs**.

NOTE: If unsure about this procedure or your efforts fail to remedy the problem, contact your **VENTRAC** dealer.

SERVICE & MAINTENANCE

PLATFORM COVER

(Figure 51)

To Remove:

1. Remove bolt at the front of the cover.
2. Pull the cover forward enough to disengage the 2 tabs at the lower rear end of the cover.
3. Lift rear part of cover to free the top 2 tabs from the chassis.
4. Continue to raise the rear part of the cover until it can be freely removed from the platform.

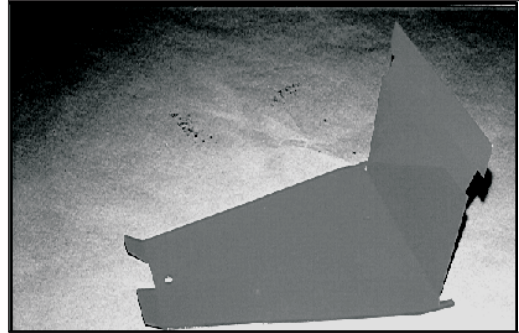

Figure 51

To install, repeat the above procedures in reverse.

⚠ WARNING

Before making any repairs or adjustments, lower attachment to the ground, set parking brake, shut the engine off, and remove the key.

PTO BELT CHANGE

(Engine to Idler)

Steps:

1. Remove belt from lower PTO idler pulley.
2. Remove belt.
3. Replace with new belt (Size B38) by reversing the procedure.



LIMITED WARRANTY – VENTRAC TURF EQUIPMENT

Venture Products, Inc. (shall be referred to as *V.P.I.*) warrants on the terms and conditions herein, that it will repair, replace, or adjust any part manufactured by *Venture Products Inc.* and found by *Venture Products Inc* to be defective in material and / or workmanship.

Effective September 1st 2005, *Ventrac* warranty on Tractors & Attachments (excluding the HG100/HG150 generator) for **Residential use only** is limited to **Three (3) years** from original purchase date. *Ventrac* Tractors & Attachments used **Commercially or for any income producing purpose** is limited to **Two (2) years** from original purchase date. *Ventrac* ET200 turbine blower (turbine only) is limited to **Two (2) years** from original purchase date. *Ventrac* HG100/HG150 generator is limited to **One (1) year** from original purchase date. *Ventrac* Tractors & Attachments used for **Rental** is limited to **180 days** from original purchase date. (**NOTE:** All accessories such as: 3-point hitch, foot pedal, dual wheel kit, etc. will be covered under the above warranty periods as they would apply provided they are installed by an Authorized *Ventrac* Dealer.) This warranty may be transferred and will carry the remainder of the warranty starting from the Original Purchase/Registration date with the dealership and/or *V.P.I.* In the event that product/s originally registered as **(3) year Residential use** are to be transferred to a commercial user the warranty would change to the remainder of **(2) year Commercial use** starting from the Original Purchase/Registration date with the dealership and/or *V.P.I.*

If this warranty covers a consumer product as defined by the Magnusson-Moss warranty act, no warranties, express or implied, (including, but not limited to, the warranty of merchantability or fitness for a particular purpose) shall extend beyond the applicable time period stated in bold face type above.

If this warranty covers a product used commercially or for any income producing purpose, the foregoing warranties are in lieu of all other warranties and no representations, guarantees or warranties, express or implied, (including, but not limited to, a warranty of merchantability or fitness for a particular purpose), are made by *V.P.I.* in connection with the manufacture or sale of its products.

The engine warranty is covered by its respective engine manufacturer. Please refer to the engine manufacturer's warranty statement that is included in the owner's manual.

The *Ventrac* turf equipment, including any defective parts, must be returned to an Authorized *Ventrac* Dealer within the warranty period. The warranty shall extend to the cost to repair or replace (as determined by *V.P.I.*) the defective part. **The expense of pickup and delivery of equipment, service call drive time or any transportation expense incurred for warranty repair is the sole responsibility of the owner and is not covered under warranty by *Ventrac* and/or *V.P.I.*** *V.P.I.*'s responsibility in respect to claims is limited to making the required repairs or replacements, and no claim of breach of warranty shall be cause for cancellation or rescission of the contract of sale of any *Ventrac* equipment. Proof of purchase may be required by the dealer to substantiate any warranty claim. Only warranty work performed and submitted by an Authorized *Ventrac* Dealer may be eligible for warranty credit.

This warranty extends only to *Ventrac* turf equipment operated under normal conditions and properly serviced and maintained. The warranty expressly does **NOT** cover: (a) any defects, damage or deterioration due to normal use, wear and tear, or exposure; (b) normal maintenance services, such as cleaning, lubrication, oil change; (c) replacement of service items, such as oil, lubricants, spark plugs, belts, rubber hoses or other items subject to normal service replacement; (d) damage or defects arising out of, or relating to abuse, misuse, neglect, alteration, negligence or accident; (e) repair or replacement arising from



LIMITED WARRANTY – VENTRAC TURF EQUIPMENT

operation of, or use of the turf equipment which is not in accordance with operating instructions as specified in the operator's manual or other operational instructions provided by *V.P.I.*; (f) repair or replacement arising as a result of any operation from *Ventrac* turf equipment that has been altered or modified so as to, in the determination of *V.P.I.*, adversely affect the operation, performance or durability of the equipment or that has altered, modified or affected the turf equipment so as to change the intended use of the product; (g) repair or replacement necessitated by the use of parts, accessories or supplies, including gasoline, oil or lubricants, incompatible with the turf equipment or other than as recommended in the operator's manual or other operational instructions provided by *V.P.I.*; (h) repairs or replacements resulting from parts or accessories which have adversely affected the operation, performance or durability of the turf equipment; or (i) damage or defects due to or arising out of repair of *Ventrac* turf equipment by person or persons other than an authorized *Ventrac* service dealer or the installation of parts other than genuine *Ventrac* parts or *Ventrac* recommended parts.

The sole liability of *V.P.I.* with respect to this warranty shall be repair and replacement as set forth herein. *V.P.I.* shall have no liability for any other cost, loss, or damage. In particular *V.P.I.* shall have no liability or responsibility for: (i) expenses relating to gasoline, oil, lubricants; (ii) loss, cost or expense relating to transportation or delivery of turf equipment from the location of owner or location where used by owner to or from any Authorized *Ventrac* Dealer; (iii) travel time, overtime, after hours time or other extraordinary repair charges or charge relating to repairs or replacements outside of normal business hours at the place of business of an Authorized *Ventrac* Dealer; (iv) rental of like or similar replacement equipment during the period of any warranty repair or replacement work; (v) any telephone or telegram charges; (vi) loss or damage to person or property other than that covered by the terms of this warranty; (vii) any claims for lost revenue, lost profit or additional cost or expense incurred as a result of a claim of breach of warranty; or (viii) attorney's fees.

The remedies of buyer set forth herein are exclusive and are in lieu of all other remedies. The liability of *V.P.I.*, whether in contract, tort, under any warranty, or otherwise, shall not extend beyond its obligation as set forth herein. *V.P.I.* shall not be liable for cost of removal or installation nor shall *V.P.I.* be responsible for any direct, indirect, special or consequential damages of any nature. In no event shall *V.P.I.* be liable for any sum in excess of the price received for the goods for which liability is claimed.

There are no representations or warranties which have been authorized to the buyer of the turf equipment other than set forth in this warranty. Any and all statements or representations made by any seller of this equipment, including those set forth in any sales literature or made orally by any sales representative, are superseded by the terms of this warranty. Any affirmation of fact or promise made by *V.P.I.* or any of its representatives to the buyer which relates to the goods that are the subject to this warranty shall not be regarded as part of the basis of the bargain and shall not be deemed to create any express warranty that such goods shall conform to the affirmation or promise.

No employee, distributor, or representative is authorized to change the foregoing warranties in any way or grant any other warranty on behalf of *V.P.I.*

Some states do not allow limitations on how long an implied warranty lasts or allow the exclusion on limitation of incidental or consequential damages, so the above limitation or exclusion may not apply to you.

This warranty gives you specific legal rights, and you may also have other rights which vary from state to state.

This warranty applies to all *Ventrac* turf equipment sold in the United States and Canada.