



OPERATOR'S MANUAL

Ventrac 3100



Revised 06/11/14
09.10045 Rev. 03



328 East Water St.
PO Box 148
Orrville, OH 44667
www.ventrac.com

A copy of the parts manual
and this operator's manual
is available at:
<http://ventrac.com/manuals>

[View all manuals](#)



To the Owner Contact Information and Product Identification

If you need to contact an authorized Ventrac dealer for information on servicing your product, always provide the product model and serial numbers.

Please fill in the following information for future reference. See the picture(s) below to find the location of the identification numbers. Record them in the spaces provided.

Date of Purchase: _____

Dealer: _____

Dealer Address: _____

Dealer Phone Number: _____

Dealer Fax Number: _____

Model # (A): _____ Serial # (B): _____ <p style="text-align: center;">Affix Part/Serial Number label here.</p>
--



Engine Serial # (C): _____



Ventrac Products Inc. reserves the right to make changes in design or specifications without obligation to make like changes on previously manufactured products.

TABLE OF CONTENTS

INTRODUCTION	PAGE 6
Product Description.....	7
Why do I need an Operator's manual?	7
Using Your Manual.....	8
Manual Glossary	8
SAFETY	PAGE 9
Safety Decals.....	9
General Safety Procedures.....	11
Training Required.....	11
Personal Protective Equipment Requirements	11
Operating Safely	11
Preventing Accidents.....	12
Keep Riders Off.....	12
Operating On Slopes.....	13
Roadway Safety	13
Truck Or Trailer Transport	13
Maintenance.....	14
Fuel Safety	14
Hydraulic Safety	15
LE3100 Safety Procedures	15
Operator Interlock Systems.....	16
OPERATIONAL CONTROLS	PAGE 17
Operational Control Locations.....	17
Ignition Key Switch (J).....	18
Steering Tilt Adjustment Lever (I)	18
Engine Oil Pressure Warning Light (C)	18
Selector Lever/Parking Brake (T).....	18
Foot Pedal (U).....	18
Attachment Lock Lever (F).....	18
Weight Transfer Adjustment Lever (G).....	19
Seat Slide Adjustment Lever (H).....	19
Auxiliary Hydraulic Quick Couplers (V)	19
Volt Gauge (A).....	19
Hour Meter & Tachometer (B)	19
S.D.L.A. Levers (L & M)	20
Power Take Off (PTO) Switch (Q)	20
Light Switch (P)	20
Throttle (O).....	20
Choke (N).....	20
12 Volt Switches (R & S)	20
12 Volt Outlet (W).....	20
12 Volt 4-Pin Socket (X).....	20

TABLE OF CONTENTS

GENERAL OPERATION	PAGE 21
Daily Inspection.....	21
Starting the Engine.....	21
Forward and Reverse.....	21
Stopping the Power Unit	22
Attaching	22
Detaching	22
Operating Attachments.....	22
Front Hitch.....	22
Weight Transfer.....	22
PTO Drive Belt	23
Front Auxiliary Couplers.....	23
12 Volt Auxiliary Outlets	23
Operating On Slopes.....	24
Towing or Pushing the Power unit.....	24
SERVICE	PAGE 25
Cleaning and General Maintenance.....	25
Lubrication Locations	26
Checking Engine RPM.....	27
Check Engine Oil Level.....	27
Changing Engine Oil and Filter	27
Cleaning Air Intake System.....	28
Servicing Air Filter Elements	29
Filling the Fuel Tank	29
Changing the Fuel Filter.....	30
Service the Battery Safely.....	30
Removing and Installing Battery	30
Cleaning Battery and Terminals	31
Using a Booster Battery	31
Changing the Headlight Bulb	32
Changing the Taillights	32
Fuses	33
Inspection of Belts.....	33
Engine Drive Belt Replacement	34
PTO Belt Replacement	35
Transaxle Drive Belt Replacement.....	36
Checking Hydraulic Oil Level	36
Changing Hydraulic Oil and Filter	36
Tire Pressure.....	36
Ventrac 3100 Maintenance Schedule	37
Ventrac 3100 Maintenance Checklist.....	38
TROUBLESHOOTING	PAGE 39
Engine.....	39
Electrical System.....	40
Hydraulic System	40
Power unit	40

TABLE OF CONTENTS

SPECIFICATIONS	PAGE 41
Engine	41
Electrical.....	41
PowerTrain.....	41
Controls & instrument Panel	41
Other features	41
Dimensions	42
Fluid Capacities.....	42
WARRANTY	PAGE 43

A copy of the parts manual
and this operator's manual
is available at:
<http://ventrac.com/manuals>



INTRODUCTION



Venture Products Inc. is pleased to provide you with your new Ventrac! We hope that Ventrac equipment will provide you with a ONE Tractor Solution.

Listed below are just some of the items that can provide you *versatility* as you use your LE3100. Please visit our web site, or contact your authorized Ventrac dealer for a complete list of items available for your new tractor.

Accessories	Item Description	Part Number	Accessories	Item Description	Part Number
	Seat Arm Rest	47.0113		Tractor Cab	70.2006
	Roll Cage	70.3015		Two-N-One Front Hitch	70.2001
	Suspension Seat	70.3020		Rear Weight Brackets	70.3017
	Weight Transfer*	70.3014		Tilt Steering*	70.3019
	Rear Auxiliary Hydraulics	70.3018		12 Volt Switch and Plug	70.3016
	Spreader	39.55500			

*Standard on the LE3200

Attachments	Item Description	Part Number	Attachments	Item Description	Part Number
	Aerator with Open Spoon Tines	39.55490		Aerator with Slitter/Slicer Tines	39.55492
	Aerator with Coring Tines	39.55494		Blade - 48"	39.55258
	Blade - 60"	39.55250		Blower	39.35445
	Broom	39.35402		Edger	39.55330
	Excavator - 30"	39.55236		Excavator - 48"	39.55230
	Field Mower - 45"	39.35102		Finish Mower - 52"	39.35100
	Finish Mower - 60"	39.35101		Rear Discharge Mower	39.35107
	Slip Scoop - 36"	39.55216		Slip Scoop - 48"	39.55210
	Snow Blower	39.35427		Stump Grinder	39.35300
	Terra Rake - 52"	39.55431		V-Blade	39.55271

INTRODUCTION

PRODUCT DESCRIPTION

- The 3100 is a unique *all-wheel-drive* power unit that distributes its power to four equal sized flotation tires for excellent control, traction, stability, maneuvering, and braking.
- An innovative, patented Tandem Drive Train, coupled with a uni-body articulated and oscillating frame creates a quiet, efficient, and powerful all-wheel-drive performer.
- The 3100 has power steering and a turning radius of 28 inches (71 cm) to maneuver in and around tight places with ease.
- Tandem hydrostatic transmissions are controlled with Ventrac's patented S.D.L.A. control which is located next to the operator allowing for easy control of Speed, Direction, Lift, and Auxiliary functions all with one hand.
- The 3100 is designed with the operator seated up-front for unobstructed visibility of attachments and terrain ahead and allows for a rear mounted engine that keeps heat, exhaust, and noise located behind the operator.
- The 3100 is equipped with Ventrac's minute mount system. This allows you to change the front mounted attachments quickly and efficiently while moving from job to job with minimal effort. A rear mounted 2" receiver hitch is also a standard feature.

WHY DO I NEED AN OPERATOR'S MANUAL?

This manual has been created to help you gain the important knowledge of what is needed to safely operate, maintain, and service your power unit. It is divided into sections for convenient reference of the appropriate section.

You must read and understand the operator's manual for each piece of Ventrac equipment you own. Reading the operator's manual will help you become familiar with each specific piece of equipment. Understanding the operator's manual will help you, as well as others, avoid personal injury and/or damage to the equipment. Keep this manual with the power unit at all times. The manual should remain with the power unit even if it is sold. If this manual becomes damaged or unreadable, it should be replaced immediately. Contact your local Ventrac dealer for a replacement.

When using a Ventrac attachment, be sure to read and follow the safety and operating instructions of both the power unit and the attachment being used to ensure the safest operation possible.

The information in this manual provides the operator with the safest procedures to operate the power unit while getting the maximum use out of the unit. Failure to follow the safety precautions listed in this manual may result in personal injury and/or damage to the equipment.

INTRODUCTION

USING YOUR MANUAL

Throughout this manual, you will encounter special messages and symbols that identify potential safety concerns to help you as well as others avoid personal injury or damage to the equipment.

SYMBOL DEFINITIONS



ATTENTION

This symbol identifies potential health and safety hazards. It marks safety precautions. Your safety and the safety of others is involved.

There are three signal words that describe the level of safety concern: Danger, Warning, and Caution. Safety should always be the #1 priority when working on or operating equipment. Accidents are more likely to occur when proper operating procedures are not followed or inexperienced operators are involved.

Note: Right-Hand and Left-Hand orientations may be referred to at different places throughout this manual. Right-Hand and Left-Hand is determined as if sitting on the power unit seat facing forward.

SIGNAL WORD DEFINITIONS

⚠ DANGER

Indicates an imminently hazardous situation which, if not avoided, will result in death or serious injury. This signal word is limited to the most extreme cases.

⚠ WARNING

Indicates a potentially hazardous situation which, if not avoided, could result in death or serious injury.

⚠ CAUTION

Indicates a potentially hazardous situation which, if not avoided, may result in minor or moderate injury and/or property damage. It may also be used to alert against unsafe practices.

MANUAL GLOSSARY

- Power Unit** A Ventrac tractor or other Ventrac engine powered device that may be operated by itself or with an attachment or accessory.
- Attachment** A piece of Ventrac equipment that requires a Power Unit for operation.
- Accessory** A device that attaches to a Power Unit or Attachment to extend its capabilities.
- Machine** Describes any "Attachment" or "Accessory" that is used in conjunction with a power unit.

SAFETY

SAFETY DECALS

The following safety decals must be maintained on your Ventrac 3100 power unit.

Keep all safety decals legible. Remove all grease, dirt, and debris from safety decals and instructional labels. If any decals are faded, illegible, or missing, contact your dealer promptly for replacements.

When new components are installed, be sure that current safety decals are affixed to the replacement components.



SAFETY

A



EXPLOSION HAZARD
To prevent an explosion or a fire:

- Do not smoke while refuelling.
- Keep smoking material, sparks and open flames away.

00.0121

B



WARNING

To prevent serious injury or death from exploding gases:

- Do not work on batteries without proper instruction and training.
- See operator's manual.

00.0124

C



WARNING

Moving parts can cause injury. Keep hands, feet and objects clear during operation.

00.0216

D



WARNING

Read and understand operator's manual before using this machine.

Failure to follow operating instructions could result in death or serious injury.

00.0217

E



WARNING

Pinch Points. Moving parts can crush or cut. KEEP CLEAR!

00.0218

F



WARNING

For the safety of all personnel, DO NOT modify or remove any of this equipment's guards, safety devices or warning labels.

00.0220

G

WARNING

OPERATE ONLY:

- * AFTER READING AND UNDERSTANDING OPERATOR MANUAL.
- * WHEN HEALTHY AND ALERT.
- * IN WELL VENTILATED AREAS.
- * WELL-MAINTAINED EQUIPMENT.
- * WITH ALL GUARDS IN PLACE.
- * RESPONSIBLY.

DO NOT OPERATE:

- * WHEN IMPAIRED.
- * ON SLOPES GREATER THAN 20 DEGREES.
- * WITH RIDERS.
- * RECKLESSLY.
- * IN A MANNER THAT WILL COMPROMISE SAFETY.

CAUTION:

- * REFER TO OPERATORS MANUAL FOR TOWING PROCEDURE.
- * SERVICE RADIATOR & FILTERS AS NEEDED.
- * SHARP TURNS REDUCE TRACTOR STABILITY.

! FAILURE TO COMPLY WITH ITEMS LISTED ABOVE MAY VOID WARRANTY !

00.0234

H



WARNING

Wear Hearing Protection

00.0291

Decal	Description	Part Number	Quantity
A	Danger, Explosion Hazard	00.0121	1
B	Warning - Battery Gases	00.0124	1
C	Warning - Moving Parts	00.0216	3
D	Warning - Read Owners Manual	00.0217	1
E	Warning - Pinching Points	00.0218	2
F	Warning - Safety Alteration	00.0220	2
G	Warning - General Safety	00.0234	1
H	Warning - Hearing PPE	00.0291	1

SAFETY



General Safety Procedures for Ventrac Power Units, Attachments, & Accessories



TRAINING REQUIRED

- The owner of this machine is solely responsible for properly training the operators.
- The owner/operator is solely responsible for the operation of this machine and prevention of accidents or injuries occurring to him/herself, other people, or property.
- Do not allow operation or service by children or untrained personnel. Local regulations may restrict the age of the operator.
- Before operating this machine, read the operator's manual and understand its contents.
- If the operator of the machine cannot understand this manual, then it is the responsibility of this machine's owner to fully explain the material within this manual to the operator.
- Learn and understand the use of all controls.
- Know how to stop the power unit and all attachments quickly in the event of an emergency.



PERSONAL PROTECTIVE EQUIPMENT REQUIREMENTS

It is the responsibility of the owner to be sure that the operators use the proper personal protective equipment while operating the machine. Required personal protective equipment includes, but is not limited to, the following list.



- Wear a certified ear protection device to prevent loss of hearing.
- Prevent eye injury by wearing safety glasses while operating the machine.
- Closed toe shoes must be worn at all times.
- Long pants must be worn at all times.
- When operating in dusty conditions, it is recommended that a dust mask be worn.

OPERATING SAFELY

- Inspect machine before operation. Repair or replace any damaged, worn, or missing parts. Be sure guards and shields are in proper working condition and are secured in place. Make all necessary adjustments before operating machine.
- Some pictures in this manual may show shields or covers opened or removed in order to clearly illustrate any instructions. Under no circumstance should the machine be operated without these devices in place.
- Alterations or modifications to this machine can reduce safety and could cause damage to the machine. Do not alter safety devices or operate with shields or covers removed.
- Before each use, verify that all controls function properly and inspect all safety devices. Do not operate if controls or safety devices are not in proper working condition.
- Check parking brake function before operating. Repair or adjust parking brake if necessary.
- Observe and follow all safety decals.
- All controls are to be operated from the operator's seat only.
- Always wear a seat belt if the machine has a roll cage/bar installed.
- Ensure the attachment or accessory is locked or fastened securely to the tractor before operating.
- Ensure that all bystanders are clear of the tractor and attachment before operating. Stop machine if someone enters your work area.
- Always be alert to what is happening around you, but do not lose focus on the task you are performing. Always look in the direction the machine is moving.
- Look behind and down before backing up to be sure of a clear path.
- If you hit an object, stop and inspect the machine. Make all necessary repairs before operating machine again.
- Stop operation immediately at any sign of equipment failure. An unusual noise can be a warning of equipment failure or a sign that maintenance is required. Make all necessary repairs before operating machine again.

SAFETY



General Safety Procedures for Ventrac Power Units, Attachments, & Accessories



OPERATING SAFELY (CONTINUED)

- If equipped with a high/low range feature, never shift between high and low range while on a slope. Always move the machine to level ground and place the selector lever in park before shifting range.
- Do not leave machine unattended while it is running.
- Always park the machine on level ground.
- Always shut off engine when connecting attachment drive belt to the power unit.
- Never leave the operator's seat without lowering the attachment to the ground, setting the parking brake, shutting off the engine, and removing the ignition key. Make sure all moving parts have come to a complete stop before dismounting.
- Never leave equipment unattended without lowering the attachment to the ground, setting the parking brake, shutting off the engine, and removing the ignition key.
- Only operate in well-lit conditions.
- Do not operate when there is a risk of lightning.
- Never direct the discharge of any attachment in the direction of people, buildings, animals, vehicles, or other objects of value.
- Never discharge material against a wall or obstruction. Material may ricochet back towards the operator.
- Use extra caution when approaching blind corners, shrubs, trees, or other objects that may obscure vision.
- Do not run the engine in a building without adequate ventilation.
- Do not touch the engine or the muffler while the engine is running or immediately after stopping the engine. These areas may be hot enough to cause a burn.
- Do not change the engine governor settings or over-speed the engine. Operating engine at excessive speed may increase the hazard of personal injury.
- To reduce the hazard of fire, keep the battery compartment, engine, and muffler areas free of grass, leaves, and excessive grease.

PREVENTING ACCIDENTS



- Clear working area of objects that might be hit or thrown from machine.
- Keep people and pets out of mowing area.
- Know the work area well before operation. Do not operate where traction or stability is questionable.
- Reduce speed when you are operating over rough ground.
- Equipment can cause serious injury and/or death when improperly used. Before operating, know and understand the operation and safety of the power unit and the attachment being used.

- Do not operate machine if you are not in good physical and mental health, if you will be distracted by personal devices, or are under the influence of any substance which might impair decision, dexterity, or judgment.
- Children are attracted to machine activity. Be aware of children and do not allow them in the working area. Turn off the machine if a child enters the work area.

KEEP RIDERS OFF

- Only allow the operator on the power unit. Keep riders off.
- Never allow riders on any attachment or accessory.

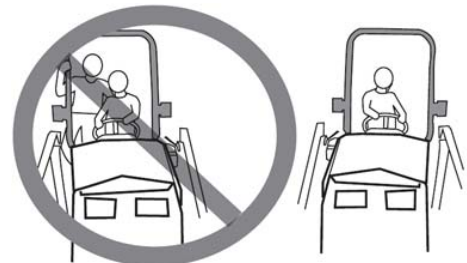

SAFETY



General Safety Procedures for Ventrac Power Units, Attachments, & Accessories



OPERATING ON SLOPES

- Slopes can cause loss-of-control and tip-over accidents, which can result in severe injury or death. Be familiar with the emergency parking brake, along with the power unit controls and their functions.
- If power unit is equipped with a fold down roll bar, it must be locked in the upright position when operating on any slope.
- Use low range (if equipped) when operating on slopes greater than 15 degrees.
- Do not stop or start suddenly when operating on slopes.
- Never shift between high and low range while on a slope. Always move the power unit to level ground and place the selector lever in park before shifting range or placing the power unit in neutral.
- Variables such as wet surface and loose ground will reduce the degree of safety. Do not drive where machine could lose traction or tip over.
- Keep alert for hidden hazards in the terrain.
- Stay away from drop-offs, ditches, and embankments.
- Sharp turns should be avoided when operating on slopes.
- Pulling loads on hills decreases safety. It is the responsibility of the owner/operator to determine loads that can safely be controlled on slopes.
- Transport machine with attachment lowered or close to the ground to improve stability.
- While operating on slopes, drive in an up and down direction when possible. If turning is necessary while driving across slopes, reduce speed and turn slowly in the downhill direction.
- Assure a sufficient supply of fuel for continuous operation. A minimum of one-half tank of fuel is recommended.

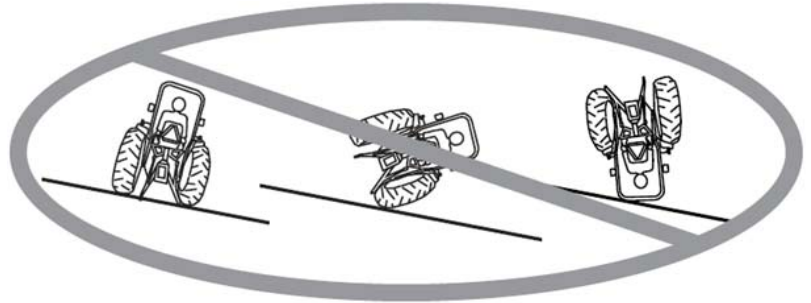

ROADWAY SAFETY

- Operate with safety lights when operating on or near roadways.
- Obey all state and local laws concerning operation on roadways.
- Slow down and be careful of traffic when operating near or crossing roadways. Stop before crossing roads or sidewalks. Use care when approaching areas or objects that may obscure vision.
- If there is doubt of safety conditions, discontinue machine operation until a time when operation can be performed safely.
- When operating near or on roadways, have a Slow Moving Vehicle Emblem clearly displayed.



TRUCK OR TRAILER TRANSPORT

- Use care when loading or unloading machine into a truck or trailer.
- The parking brake is not sufficient to lock the machine during transport. Always secure the power unit and/or attachment to the transporting vehicle.
- Shut off fuel supply to power unit during transport on truck or trailer.
- If equipped, turn the battery disconnect switch to the Off position to shut off electrical power.

SAFETY



General Safety Procedures for Ventrac Power Units, Attachments, & Accessories



MAINTENANCE

- Keep all safety decals legible. Remove all grease dirt, and debris from safety decals and instructional labels.
- If any decals are faded, illegible, or missing, contact your dealer promptly for replacements.
- When new components are installed, be sure that current safety decals are affixed to the replacement components.
- If any component requires replacement, use only original Ventrac replacement parts.
- Always disconnect the negative battery cable from the battery when working with electrical components.
- Keep all bolts, nuts, screws, and other fasteners properly tightened.
- Always lower the attachment to the ground, engage parking brake, shut off engine, and remove the ignition key. Make sure all moving parts have come to a complete stop before cleaning, inspection, adjusting or repairing.
- If the power unit, attachment, or accessory requires repairs or adjustments not instructed in the operator's manual, the power unit, attachment, or accessory must be taken to an authorized Ventrac dealer for service.
- Never perform maintenance on the power unit and/or attachment if someone is sitting in the operator's seat.
- Always use protective glasses when handling the battery.
- Check all fuel lines for tightness and wear on a regular basis. Tighten or repair them as needed.
- To reduce the hazard of fire, keep the battery compartment, engine, and muffler areas free of grass, leaves, and excessive grease.
- Do not touch the engine or the muffler while the engine is running or immediately after stopping the engine. These areas may be hot enough to cause a burn.
- Do not change the engine governor settings or over-speed the engine. Operating engine at excessive speed may increase the hazard of personal injury.
- Springs may contain stored energy. Use caution when disengaging or removing springs and/or spring loaded components.
- An obstruction or blockage in a drive system or moving/rotating parts may cause a buildup of stored energy. When the obstruction or blockage is removed, the drive system or moving/rotating parts may move suddenly. Do not attempt to remove an obstruction or blockage with your hands. Keep hands, feet, and clothing away from all power-driven parts.
- Dispose of all fluids in accordance with local laws.

FUEL SAFETY



- Do not refuel machine while smoking or at a location near flames or sparks.
- Always refuel the machine outdoors.
- Do not store machine or fuel container indoors where fumes or fuel can reach an open flame, spark, or pilot light.
- Only store fuel in an approved container. Keep out of reach of children.
- Never remove fuel cap or add fuel with the engine running. Allow engine to cool before refueling.
- Never remove fuel cap while on a slope. Only remove when parked on a level surface.
- Replace all fuel tank and container caps securely.
- Do not overfill fuel tank. Only fill to bottom of fuel neck, do not fill fuel neck full. Overfilling of fuel tank could result in engine flooding or fuel leakage from the tank.
- If fuel is spilled, do not attempt to start the engine. Move the power unit away from the fuel spill and avoid creating any source of ignition until fuel vapors have dissipated.
- If the fuel tank must be drained, it should be drained outdoors into an approved container.
- Dispose of all fluids in accordance with local laws.
- Check all fuel lines for tightness and wear on a regular basis. Tighten or repair them as needed.
- The fuel system is equipped with a shut-off valve. Shut off the fuel when transporting the machine to and from the job, when parking the machine indoors, or when servicing the fuel system.

SAFETY



General Safety Procedures for Ventrac Power Units, Attachments, & Accessories



HYDRAULIC SAFETY

- Make sure all hydraulic connections are tight and all hydraulic hoses and tubes are in good condition. Repair any leaks and replace any damaged or deteriorated hoses or tubes before starting the machine.
- Hydraulic leaks can occur under high pressure. Hydraulic leaks require special care and attention.
- Use a piece of cardboard and a magnifying glass to locate suspected hydraulic leaks.

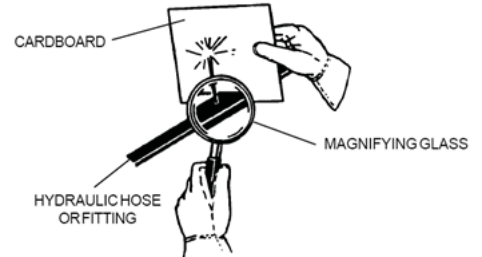

- Keep body and hands away from pinhole leaks or nozzles that eject high pressure hydraulic fluid. Hydraulic fluid escaping under high pressure can penetrate the skin causing serious injury. If hydraulic fluid is injected into skin, seek immediate medical attention.
- Hydraulic system may contain stored energy. Before performing maintenance or repairs on the hydraulic system, remove attachments, engage parking brake, disengage weight transfer system (if equipped), shut off engine, and remove ignition key. To relieve pressure on the auxiliary hydraulic system, shut off the power unit engine and move the secondary S.D.L.A. lever left and right before disconnecting the auxiliary hydraulic quick couplers.
- Dispose of all fluids in accordance with local laws.



LE3100 Safety Procedures



CALIFORNIA PROPOSITION 65 Battery Warning

Battery posts, terminals, and related accessories contain lead and lead compounds, chemicals known to the State of California to cause cancer and reproductive harm. Wash hands after handling!

⚠ WARNING

The engine exhaust from this product contains chemicals known to the State of California to cause cancer, birth defects or other reproductive harm.

- Power unit hydraulic system may contain stored energy. Before performing maintenance or repairs on the attachment hydraulic system, remove attachments, engage parking brake, disengage weight transfer system, shut off engine, and remove ignition key.
- Weight transfer springs may contain stored energy. Always disengage the weight transfer system before performing maintenance or repairs on the weight transfer system, the front hitch, or the lift hydraulics.

SAFETY



LE3100 Safety Procedures



OPERATOR INTERLOCK SYSTEMS

The operator interlock systems:

- prevent the engine from starting unless the selector lever is in the park position.
- prevent the PTO clutch from engaging unless the operator is present on the seat and activates the PTO.
- shuts off the power unit (and PTO) if the operator leaves the seat while the PTO is engaged.
- prevents the power unit from moving unless the parking brake is released and the operator is present on the seat.

Park the power unit on a level surface. Lower attachment to the ground (if attached) and turn off power unit engine. Chock tires to prevent rolling. Ensure the operating area is free of obstacles and bystanders.

Perform the following tests:

- The Ignition Circuit and Run Circuit: Selector Lever and PTO Switch
 - Sit on the seat.
 - Place the power unit's selector lever in the park position.
 - Turn ignition key to 'start'. **Starter should engage.**
 - Place the power unit's selector lever in the neutral assist position.
 - Turn ignition key to 'start'. **Starter should NOT engage.**
 - Return the power unit's selector lever to the park position.
 - Pull upwards on the PTO switch to activate the PTO.
 - Turn ignition key to 'start'. **Starter should NOT engage.**
 - Press the PTO switch to deactivate the PTO. Turn off the ignition key to shut off the ignition system.
- The PTO Circuit - Operator Presence
 - Sit on the seat.
 - Start the power unit engine.
 - Pull upwards on the PTO switch to activate the PTO.
 - Rise off the seat. **The engine should shut off.** NOTE: if you return to the seat before the engine completely stops, the engine (and PTO) will re-power.
 - Press the PTO switch to deactivate the PTO. Turn off the ignition key to shut off the ignition system.

Place the power unit's selector lever in the park position and remove the wheel chocks.

- S.D.L.A. Control Lever and Parking Brake
 - Sit on the seat.
 - Start the power unit engine and raise the attachment (if attached).
 - With the selector lever still in the park position, slowly move the S.D.L.A. control lever forward and rearward. **The power unit should NOT move.**
 - Place the power unit's selector lever in the neutral assist position. Slowly move the S.D.L.A. control lever forward and rearward. The power unit should drive according to the input of the S.D.L.A. control lever. **When released, the S.D.L.A. control lever should return to the neutral position.**

Interlock tests are complete. If any test fails, do not operate. Repair before operating.

OPERATIONAL CONTROLS

OPERATIONAL CONTROL LOCATIONS

The images above match with reference letters below to help identify the locations of operational controls for this power unit.



- A - Volt Gauge
- B - Hour Meter & Tachometer
- C - Engine Oil Pressure Warning Light
- D - Water in Fuel Warning Light (Diesel only)
- E - Glow Plug Indicator Light (Diesel only)

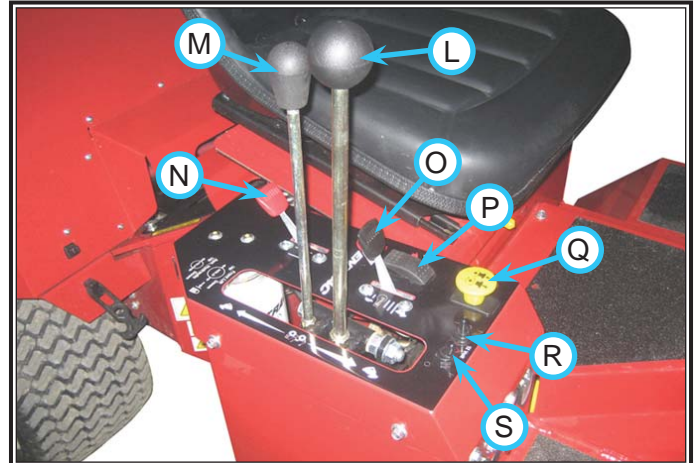

- L - Primary S.D.L.A. Lever
- M - Secondary S.D.L.A. Lever
- N - Choke
- O - Throttle
- P - Light Switch
- Q PTO Switch
- R - 12 Volt Switch (Momentary On/Off/On)*
- S - 12 Volt Switch (On/Off)*

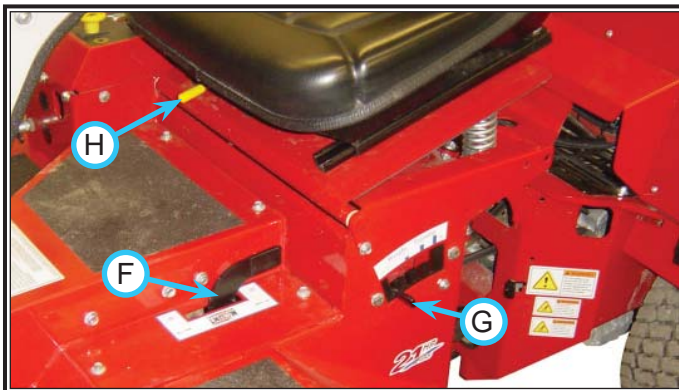

- F - Attachment Lock Lever
- G - Weight Transfer Adjustment Lever*
- H - Seat Slide Adjustment Lever

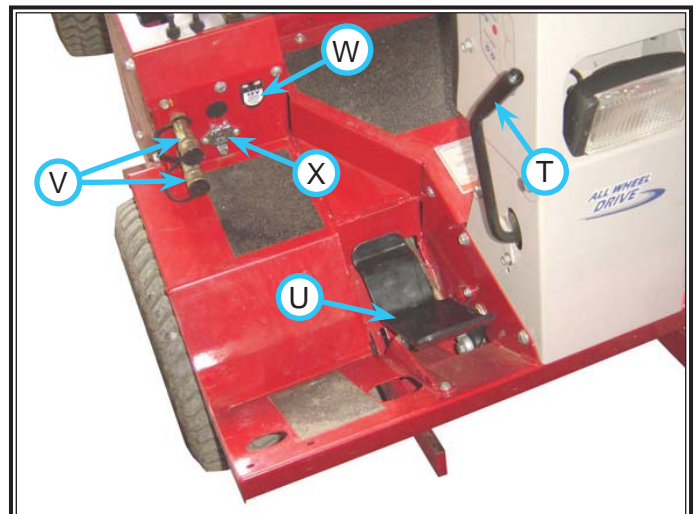

- T - Selector Lever/Parking Brake
- U - Foot Pedal
- V - Auxiliary Hydraulics Quick Couplers
- W 12 Volt Outlet*
- X - 12 Volt 4-Pin Socket*

- I - Steering Tilt Adjustment Lever*
- J - Ignition Key Switch



*Optional Equipment

OPERATIONAL CONTROLS

IGNITION KEY SWITCH (J)

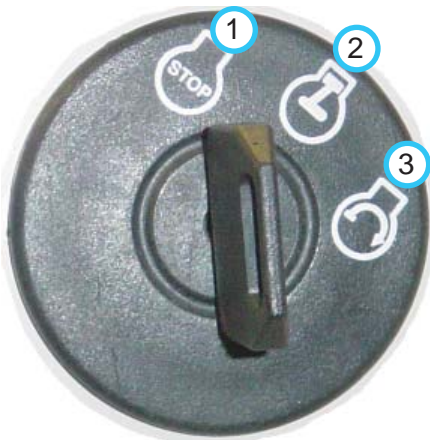

1. Off or Stop Position - All 12 volt power going through the key switch is off.
2. On or Run Position - Engine run position.
3. Start Position - When the key is turned to the start position, the starter will engage.

STEERING TILT ADJUSTMENT LEVER (I)

Optional kit # 70.3019. The steering tilt adjustment lever allows the operator to tilt the steering column forward or rearward by pushing the lever down and moving the steering column to the desired position. Releasing the lever locks the column in position.

ENGINE OIL PRESSURE WARNING LIGHT (C)

Signifies low or no engine oil pressure.

SELECTOR LEVER/PARKING BRAKE (T)

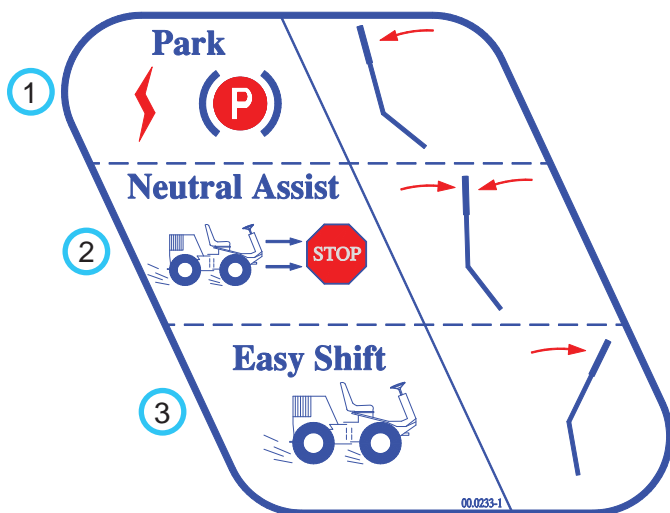

1 - In this position, the park brake is applied. The lever must be in this position for starting. When leaving the seat with the engine running, the lever must be in this position or the power unit will automatically shut off. The foot pedal control and the S.D.L.A. control lever are locked while in this position.

2 - In this position, the park brake and the control lever are released and the power unit can be operated. This also causes the control lever to have a “spring assist to neutral” action, when removing your hand from the control lever it will return to neutral. This position makes neutral easy to find and maintain. It is recommended that this position be used when learning the operation of the Ventrac, loading and unloading, attaching and removing attachments, and whenever the operator is working in tight areas or is unsure of the power unit’s response to the task being performed.

3 - In this position, the control lever is in an “easy shift mode”. This position is recommended for operating the power unit in open areas where travel speed and direction are relatively constant and control is easily maintained. Easy shift mode reduces operator arm fatigue when using the power unit for prolonged periods of time. Note: Stopping in this position requires the operator to return the S.D.L.A. control or foot pedal to the neutral position.

FOOT PEDAL (U)

The foot pedal works in conjunction with the S.D.L.A. lever and can be used to control direction and speed when the operator’s hand is removed from the S.D.L.A. lever.

ATTACHMENT LOCK LEVER (F)



The attachment lock lever engages the hitch lock for attaching or detaching Ventrac attachments.

OPERATIONAL CONTROLS

WEIGHT TRANSFER ADJUSTMENT LEVER (G)



Optional Kit # 70.3014. The weight transfer system transfers weight from the attachment to the front wheels of the power unit. The operator can select different transfer rates by selecting one of the four positions. Note: the front hitch must be fully raised to adjust the lever.

SEAT SLIDE ADJUSTMENT LEVER (H)



Move lever to the left to release lock. Slide the seat to the desired location and release the lever.

AUXILIARY HYDRAULIC QUICK COUPLERS (V)



The two couplers are a part of the auxiliary hydraulic circuit and are used with an attachment which requires hydraulics (e.g. to angle a dozer blade or rotate the discharge on the snow blower).

VOLT GAUGE (A)

Displays the voltage level of the charging system.

HR METER & TACHOMETER (B)

The hour meter shows engine run time in hours, when the engine is not running. When the engine is running, the engine RPM is displayed.

OPERATIONAL CONTROLS

S.D.L.A. LEVERS (L & M)

(Speed, Direction, Lift, & Auxiliary Control Levers)

The S.D.L.A. is the primary control for the power unit and consists of two parts: the primary lever (L) controls the Speed, Direction of power unit, and Lift of the power unit hitch arms. The secondary lever (M) controls the Auxiliary hydraulic circuit of the power unit.

S - Speed: The amount of forward or backward movement of this lever controls the ground speed of the power unit.

D - Direction: The forward or backward movement of this lever controls the direction of the power unit.

L - Lift: The lift function of the lever has four positions: Up, Hold, Down, and Float Lock. "Hold" is the default position; this holds the lift arms from moving up or down. Pulling the lever to the left raises the hitch arms. Pushing the lever to the right lowers the hitch arms. Float position is attained by pushing the lever to the right until the float detent locks the lever in place.

A - Auxiliary: The left or right movement of the secondary lever controls the functions of attachments that require the auxiliary hydraulic circuit.

POWER TAKE OFF (PTO) SWITCH (Q)

Pulling up on the knob engages the electric clutch to provide power to the front attachment. Pushing down on the knob will turn the clutch off and apply the clutch brake to stop the attachment. Note: The PTO will turn off automatically if the operator leaves the seat. The PTO can be restarted by turning the PTO switch off and then on again.

LIGHT SWITCH (P)

Pushing the front of the switch down will turn on the headlight, the taillights, and the backlighting on the dash gauges. Pushing the rear part of the switch down will turn the lights off. Lights work only when the ignition key is in the run or start position.

THROTTLE (O)

Moving the throttle lever forward increases the engine Revolutions Per Minute (RPM). Moving the throttle lever back slows the engine to an idle.

CHOKE (N)

Moving the lever forward increases the amount of gas that the engine burns, which aids in starting the engine.

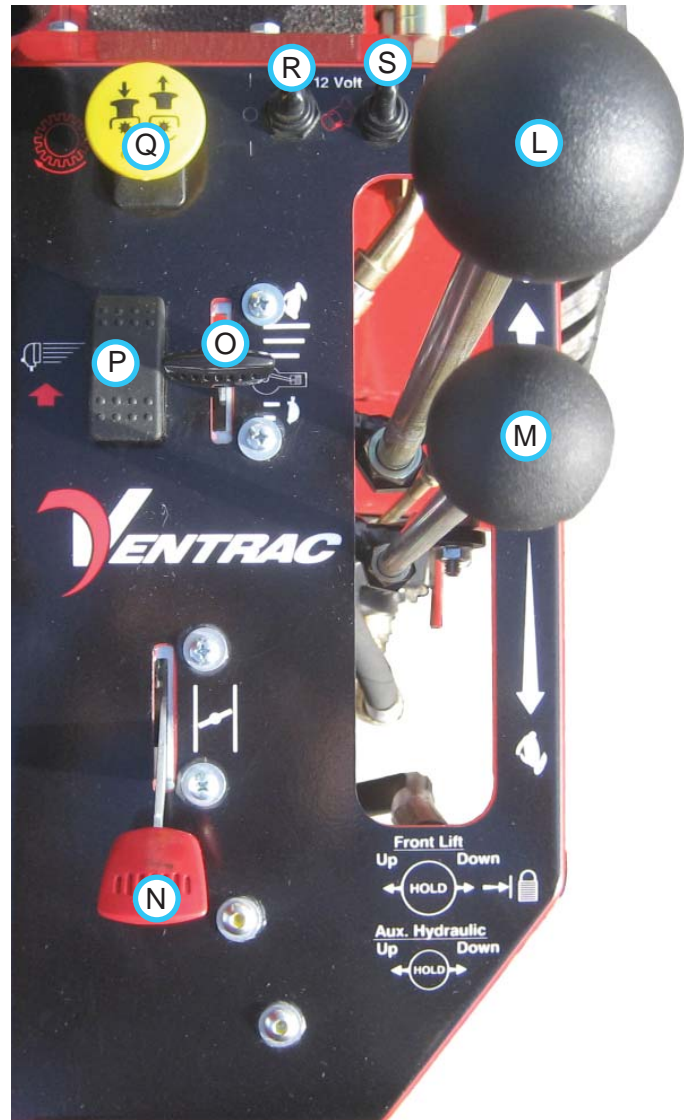

12 VOLT SWITCHES (R & S)

Optional accessory for the 3100. These switches turn Off and On the 12 volt accessories utilized by some attachments.

12 VOLT OUTLET (W)

Optional accessory. The outlet provides 12 volts of electrical power for a variety of products such as cell phones, radios, spot lights, air compressors, and more.

12 VOLT 4-PIN SOCKET (X)

Optional accessory. The socket is controlled by the 12 volt switches and provides electrical power to attachments equipped with electrical controls.

GENERAL OPERATION

DAILY INSPECTION

⚠ WARNING

Always set the parking brake, shut off the tractor engine, remove the ignition key, and ensure all moving parts have stopped before checking mower deck or blade condition, or attempting any repair or adjustment.

1. Park the power unit on a level surface, with the engine shut off and all fluids cold.
2. Perform a visual inspection of the power unit. Look for loose or missing hardware, damaged components, or signs of wear. Inspect hydraulic hoses, hydraulic fittings, and fuel lines to ensure tight, leak free connections.
3. Inspect power unit belts for wear. Belts should be in good condition. Replace if necessary.
4. Check the power unit's engine oil, hydraulic oil, cooling system, tire pressure, and fuel level. Add fluid or service system as required.
5. Refer to the power unit operator's manual. Test the power unit's operator safety interlock system.

STARTING THE ENGINE

The 3100 is equipped with an interlock system for your safety. The following procedure must be followed to start the power unit:

1. The interlock system requires the "Selector Lever" to be in the Park position, the S.D.L.A. lever to be in the neutral position, and the PTO switch to be turned off.
2. Move the throttle forward approximately $\frac{1}{4}$ of its travel.
3. Slide the choke lever to the on position.
4. Turn the key to the Start position and hold to engage starter. Release key when engine starts. Note: If engine fails to start, refer to troubleshooting section.
5. Return choke to the off position.
6. The engine and hydraulic oil must be warmed to operating temperature before operations. Allow the unit to run at approximately 1,800 RPM until the hydraulic filter is warm to touch. The filter is located under the control dash panel.

⚠ CAUTION

Allow time for the hydraulic oil to circulate before the power unit is operated. Severe damage could result to the hydraulic system if adequate warm up is not allowed. Warm up time is increased in colder weather.

FORWARD AND REVERSE

1. Verify that the intended path is safe and free from obstacles. When safe to move, begin by moving the selector lever into either the neutral assist position or the easy shift position.
2. Power unit movement is controlled by moving the S.D.L.A. control lever in the desired direction of travel. Push the S.D.L.A. control lever forward to move power unit in the forward direction, or pull the S.D.L.A. control lever backward to make the power unit move in the reverse direction. Changing the amount the S.D.L.A. control lever is moved instantly changes the ground speed of the power unit. Moving it one half of the stroke will result in approximately one half of the maximum ground speed. Moving it to the end of the stroke will result in maximum ground speed.

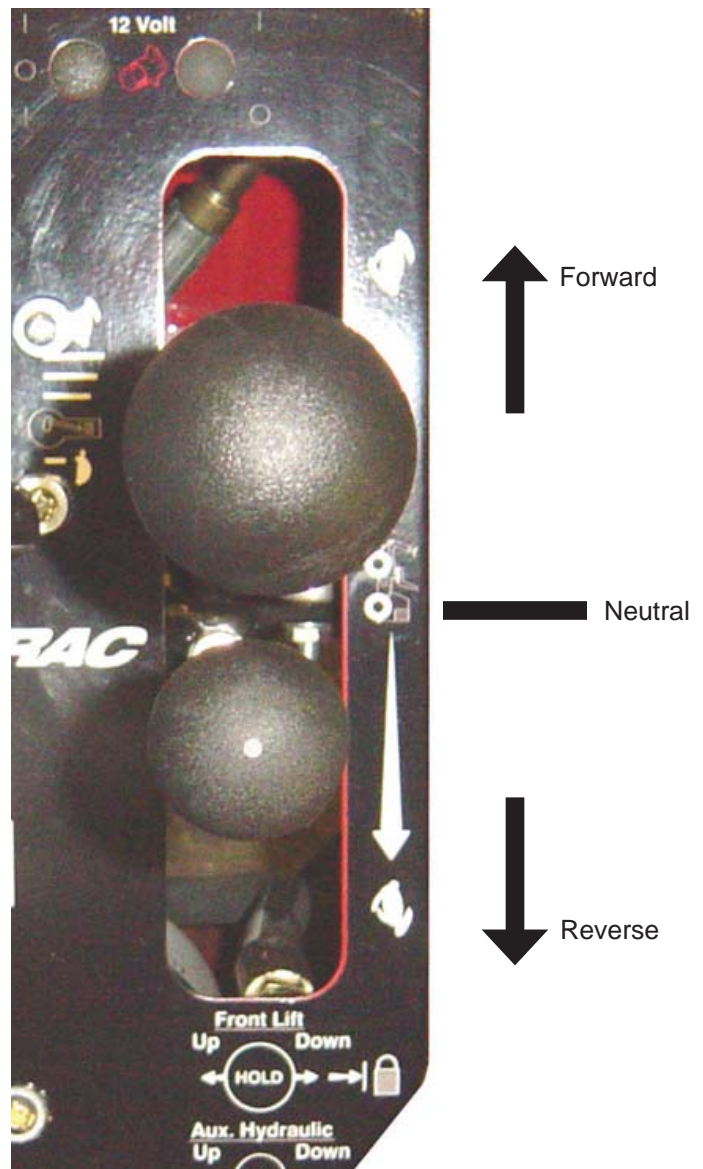

GENERAL OPERATION

STOPPING THE POWER UNIT

To slow or stop the power unit, move the S.D.L.A. control lever in the opposite direction that you are traveling. Return the S.D.L.A. control lever to the neutral position to make a complete stop. A foot pedal brake is not required because you use the S.D.L.A. control lever to stop the power unit. If in the case of an emergency and the power unit cannot be stopped with the S.D.L.A. control lever, pull the selector lever to the park position to stop the power unit.

CAUTION

If the selector lever is placed in the park position in the case of an emergency, the power unit will come to an abrupt stop.

ATTACHING

1. Drive the power unit slowly forward into the hitch arms on the attachment. Align the lift arms of the power unit with the attachment hitch arms by raising or lowering the front hitch to complete the engagement.
2. Once completely engaged, close the front hitch locking lever.
3. Engage the parking brake and shut off the engine.
4. Place the attachment belt onto the PTO drive pulley on the power unit. Ensure the belt is properly seated in each pulley.*
5. Engage the attachment's PTO belt tensioner.*
6. Wipe hose ends clean, and connect to the power unit's hydraulic quick couplers.*
7. Connect electric plug to matching socket.*

DETACHING

1. Park the power unit on a level surface and set the parking brake.
2. Fully raise the attachment and set weight transfer to the off position.
3. Lower the attachment to the ground.
4. Shut off power unit engine.
5. Disengage the attachment's PTO belt tensioner.*
6. Remove the attachment belt from the PTO drive pulley of the power unit.*
7. Move the secondary S.D.L.A. lever left and right to release pressure from the auxiliary hydraulic circuit and disconnect the hydraulic quick couplers from the power unit.*
8. Disconnect the electric plug from the socket.*

*Applies only if attachment is equipped.

9. Disengage the front hitch locking lever.
10. Restart power unit and slowly back away from the attachment.

OPERATING ATTACHMENTS

Refer to the attachment's manual for proper operation and use of the particular attachment that is being operated.

FRONT HITCH

The front hitch is used to secure the attachment to the power unit, and to raise and lower the attachment. The front hitch is controlled by the primary S.D.L.A. lever. Pull the lever toward the operator's seat to raise the attachment, push the S.D.L.A. lever away from the operator's seat to lower the attachment. The primary S.D.L.A. is equipped with a 'float' position. Push the S.D.L.A. lever to the far right position until the float detent catches and stays in place to operate in float.

WEIGHT TRANSFER

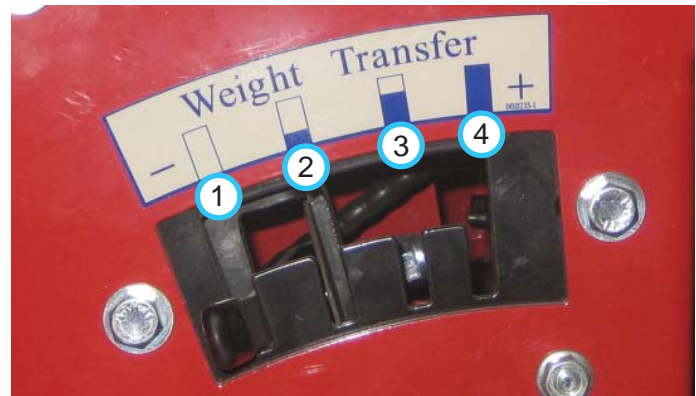

Optional kit # 70.3014: the weight transfer system allows the operator to select the amount of weight transferred from the front mounted attachment to the front drive wheels of the power unit. Transferring weight from the attachment to the power unit improves traction and hillside stability, aids in lifting, reduces steering effort, and lessens the attachment resistance when in contact with the ground. Note: The weight transfer system is only active while the primary S.D.L.A. is in the float position.

- 1 - Off. This position does not transfer any weight from the attachment to the power unit.
- 2 - Low. Transfers more weight than position 1, but less than position 3.
- 3 - Medium. Transfers more weight than position 2, but less than position 4.
- 4 - High. Transfers maximum weight allowed by the weight transfer springs.

Selecting the different positions can only be done

GENERAL OPERATION

when the front hitch is raised to its maximum height. Selecting the proper amount of weight to transfer depends on attachments, ground conditions, and operator preference. A lightweight attachment (e.g. LA162 Power Blower) will not go down with full weight transfer on. With full weight transfer on and mowing in the float position, the mower may not come down quickly enough when going through dips. Weight transfer must be reduced or speed must be lowered.

PTO DRIVE BELT



If the attachment requires a drive belt, then release the tension from the attachment drive belt and loop the belt around the drive pulley at the location shown in the figure above. When belt is in place around the bottom drive pulley, tension the belt of the attachment.

Engage the PTO by pulling up on the PTO switch on the control panel. Note: PTO will engage only if the operator is present on the seat.

FRONT AUXILIARY COUPLERS

If the attachment requires auxiliary hydraulics, couple the attachment hoses with the front auxiliary couplers. This is done by sliding the collar of the coupler rearward, inserting the end of the attachment hose into the coupler and releasing the collar. If the collar will not snap forward on its own, pull it forward manually.

⚠ CAUTION

Dirt and other debris in the hydraulic system can cause damage to the system. Wipe clean the mating parts of the couplers before coupling.
Use protective rubber plugs over power unit couplers when not in use.

If equipped, connect the hoses and quick couplers so the red indicators are paired together and the

yellow indicators are paired together. If power unit or attachment is not equipped with red and yellow indicators, connect the hoses and quick couplers and test the action of the attachment. If the action is not the desired motion, switch the hoses that the couplers are attached to. Auxiliary valves are controlled by moving the secondary S.D.L.A. lever left or right.

NOTE: pressure buildup in the attachment hose and on the power unit couplers may occur causing difficult installation of hoses. If hoses do not easily connect, try one or both of the following steps.

1. To release the pressure from the power unit couplers, turn off engine and move the secondary S.D.L.A. lever right and left to release pressure in the power unit hydraulic circuit.
2. To release pressure in the attachment hose, loosen one of the hose ends and retighten after the pressure is released.

12 VOLT AUXILIARY OUTLETS

Optional kit # 70.3016. Certain attachments require a 12 volt auxiliary outlet. Plug the attachment's 12 volt power cord into the 12 volt 4-pin socket located in front of the main control panel. Two switches are used to control the actions of the 12 volt plug. A momentary on/off/of switch is used for controlling movement that is only used for a brief time. An on/off switch is used to activate equipment or select different functions.

GENERAL OPERATION

OPERATING ON SLOPES

⚠ WARNING

Operation on slopes decreases power unit stability and increases the potential for unexpected difficulties. Only experienced operators should operate the power unit on slopes and extra caution should be applied.

Avoid uneven, loose, or wet terrain.

Stay clear of drop-offs, holes, ditches, rocks, or objects that could cause a sudden and/or unexpected force on the power unit.

Make slow and cautious starts, stops, and turns. Maximum operation is 20/25 degrees as shown in the diagram below.

Turn downhill when possible and/or reduce the degree of turns.

Failure to follow items listed above or to use common sense while operating on slopes can result in injury or death. Always operate on slopes with extreme caution.

To prevent fuel spillage, do not remove the fuel tank cap while power unit is on a slope.

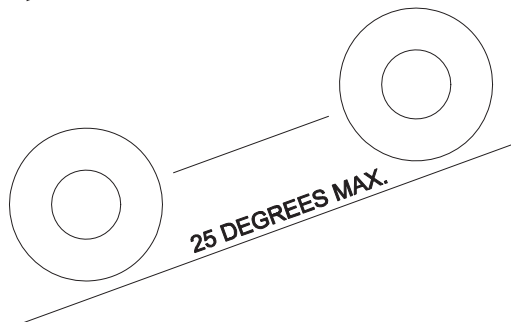
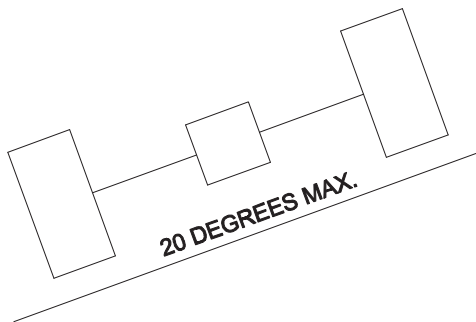

1. Maintain sufficient fuel in tank to assure continuous operation.
2. Cease operation if power unit stability is questionable, or if the operator is uncomfortable or unsure of continuing safely.
3. Attachments affect the stability of the power unit. Each attachment will affect the power unit differently.

4. Increase the amount of weight being transferred to the power unit from the attachment while operating on slopes. See weight transfer section.
5. A roll over protection device and seat belt are recommended for operation on slopes.
6. Always operate carefully and in a manner that does not compromise safety.

TOWING OR PUSHING THE POWER UNIT

If towing the power unit is necessary, the transaxles must be disengaged. Transaxles are equipped with levers to release the hydrostatic pumps for slow, level, short distance towing (off road only)! Both transaxle release levers are located in the center pivot area of the power unit. See Figures A & B below. For both handles, pull the handle out until it can be secured in the locking notch. Always release both handles when towing is complete! Failure to release one or both handles creates a potential free-wheeling hazard. The park brake is still operative in freewheeling mode, but must be released in order to tow. Note: steering may not function while towing.

⚠ CAUTION

Before towing or pushing, read and understand the information above. Damage may occur to unit if proper towing procedure is not followed.



Figure A



Figure B

SERVICE

⚠ WARNING

Always set the parking brake, shut off power unit engine, remove the ignition key, and ensure all moving parts have come to a complete stop before inspecting components or attempting any repair or adjustment.



Attention

If any component requires replacement, use only original Ventrac replacement parts.

CLEANING AND GENERAL MAINTENANCE

For best results, and to maintain the finish of the power unit, clean or wash the power unit to remove accumulated clippings, leaves, dirt, and other debris when the job is finished.

Proper and timely service of this power unit is critical to keep the power unit in a safe and reliable operating condition. Follow the Maintenance Schedule at the end of the service section.

Throughout the Service Section, different access points are referred to. Following is a list of shields and covers that may need to be removed or opened during service.

- A - Engine Drive Belt Shield
- B - Right Vertical Shaft Shield
- C - Tunnel Access Cover
- D - Left Vertical Shaft Shield
- E - Engine Hood
- F - Hydraulic Access Cover
- G - Seat Plate

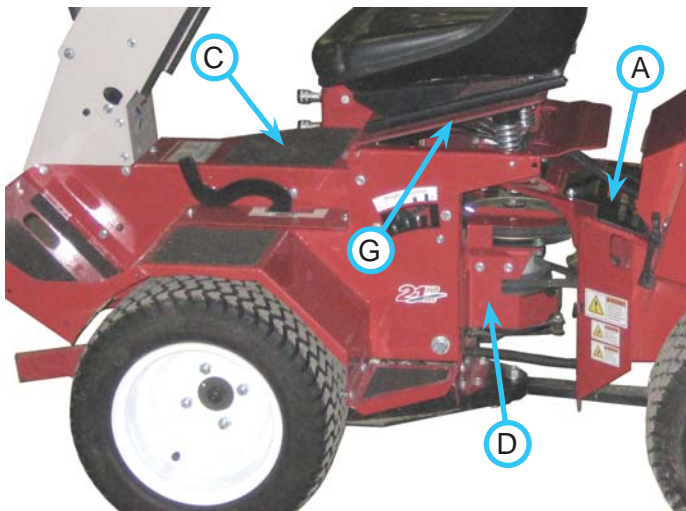

SERVICE

LUBRICATION LOCATIONS

Lubrication is required at the following locations. For service intervals, see Maintenance Schedule. When greasing pivot points and bearings, use only one pump of grease.

Front Lift Cylinder and Front Steering Cylinder



S.D.L.A. Bearings and Rear Lift Cylinder

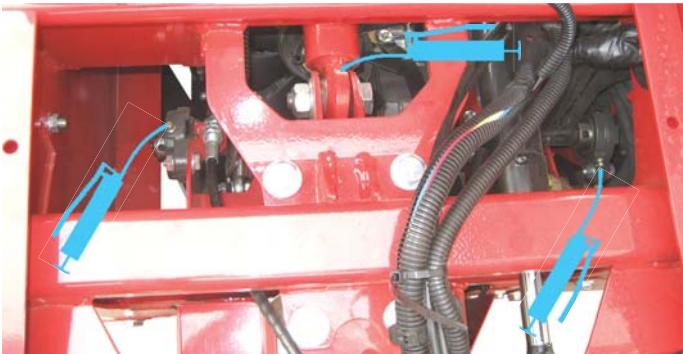

Rear Steering Cylinder and Center Pivot

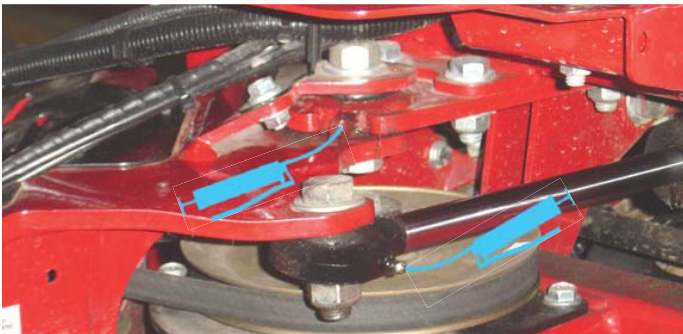

Connector Link (Front)

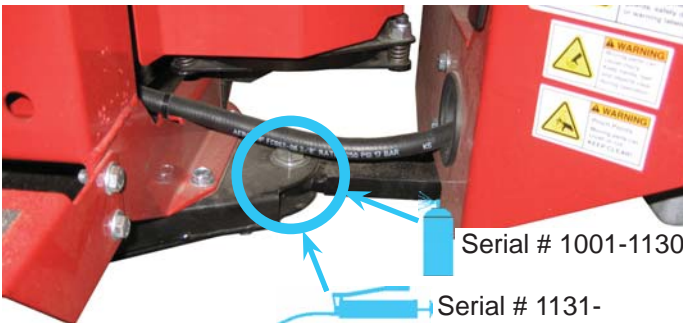

Grease

Lithium Complex
NLGI #2 type grease.

Spray Lube



Connector Link (Rear)

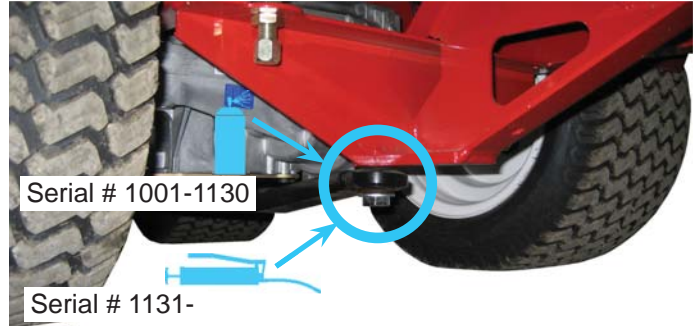

Transaxle Neutral Arm (Front)

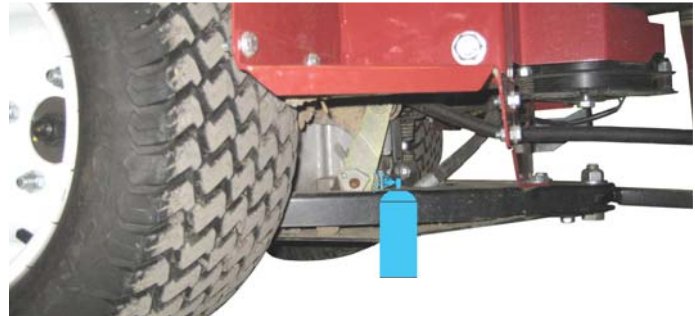

Transaxle Neutral Arm (Rear)

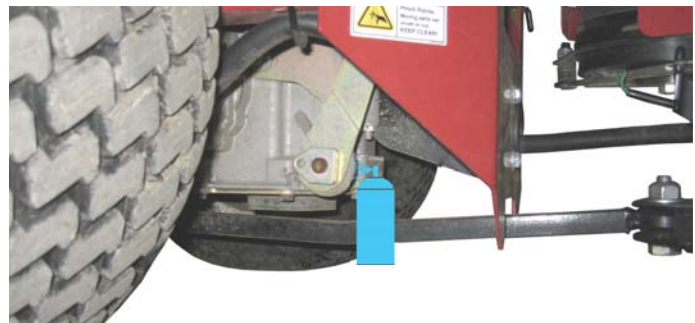

Seat Rails



SERVICE

CHECKING ENGINE RPM

Check engine RPM's when engine is warmed up and not under load.

Observe Tachometer

- Slow idle (No Load) - 1500 +/-50
- Fast idle (No Load) - 3200 +/-50
- Fast idle (European model) - 3000 +/-50

If engine rpm is incorrect, contact your local Ventrac dealer.

CHECK ENGINE OIL LEVEL

⚠ ATTENTION: Avoid damage to your engine. Failure to check the oil level regularly could lead to serious damage to your engine, if the engine is run with an incorrect oil level.

- Before operation, check engine oil with the unit sitting on a level surface.
- Check oil level when the engine is cold and not running.
- Keep oil level between the FULL and ADD marks.
- Shut off engine before adding oil.

1. Park power unit on a level surface.
2. Shut off engine and engage parking brake.
3. Remove ignition key from switch.
4. Open up engine hood to access the engine compartment.
5. Remove the dipstick (A) located at the front left of the engine. Wipe dipstick with a clean cloth.

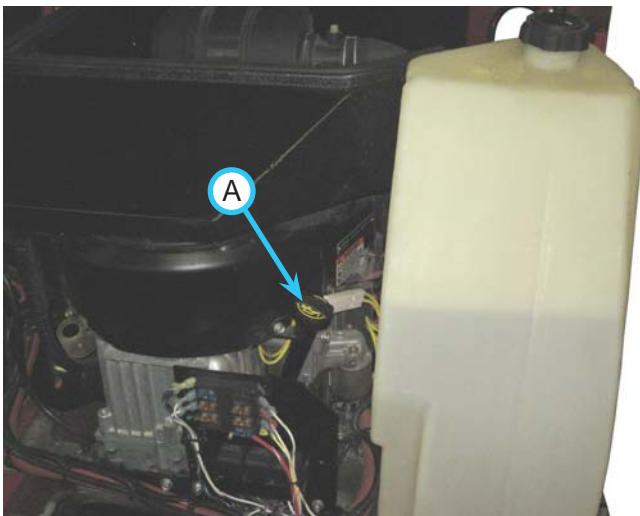

6. Install dipstick back into engine and remove again.

7. Inspect oil level. Level should be between the Add (A) and Full (B) marks on the dipstick. If oil is low, add small amounts of oil to bring the oil level no higher than Full (B) on the dipstick. If the oil level is above Full (B), drain to achieve proper level.



8. Install dipstick.
9. Close the hood.

CHANGING ENGINE OIL AND FILTER

⚠ CAUTION

Environmental Hazard!

Oil is hazardous to the environment. Dispose of oil in an approved container and at a proper recycle center.

1. Run engine for 5 minutes to warm up the oil.
2. Park power unit on a level surface.
3. Shut off engine and engage parking brake.
4. Remove ignition key from switch.
5. Open engine hood to access the oil and oil filter.
6. Place a drain pan under the oil drain on the rear frame of the power unit.
7. Remove drain cap (A) from oil drain located on rear frame under the engine.



SERVICE

8. Remove the oil filter (B) located at the right side of the engine. Turn filter counterclockwise to remove.

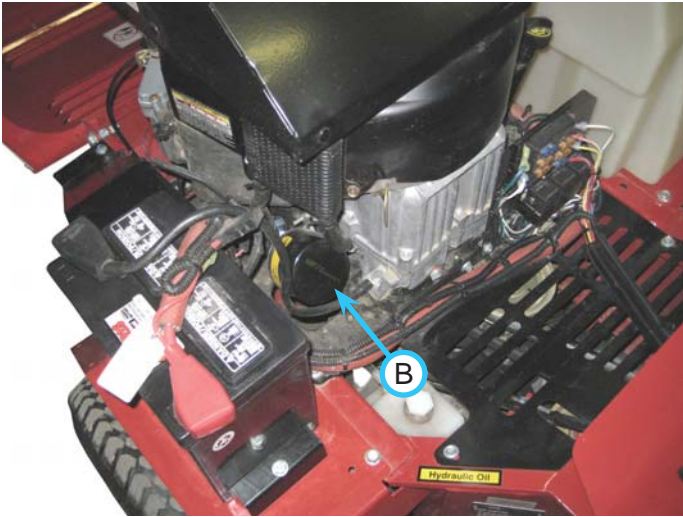

9. Wipe the filter mounting surface clean with a clean cloth.
10. Apply a thin film of clean engine oil to gasket of oil filter.
11. Install new filter. NOTE: Turn filter clockwise until filter gasket makes contact with the mounting surface. Tighten 1/2 -3/4 turn after gasket contact.
12. Install oil drain cap. DO NOT overtighten.
13. Remove the oil dipstick.
14. Add oil to engine. (See engine owner's manual for proper oil and capacity).
15. Install oil dipstick.
16. Start engine and allow to run at slow idle for approximately 2 minutes.
17. Stop engine.
18. Remove ignition key from switch.
19. Check oil level after allowing engine to cool for approximately 2 minutes.
20. Refer to "Checking Engine Oil Level" for proper procedures on how to check the oil.

CLEANING AIR INTAKE SYSTEM

⚠ CAUTION

Avoid personal injury! Wear personal eye protection when using compressed air or water for cleaning process.

⚠ ATTENTION: Avoid engine damage!

Air intake screens must be clean to prevent the engine from overheating and to allow adequate air flow.

1. Park power unit on a level surface.
2. Shut off engine and engage parking brake.
3. Remove ignition key from switch.
4. Allow engine to cool.
5. Open up engine hood to access engine compartment.

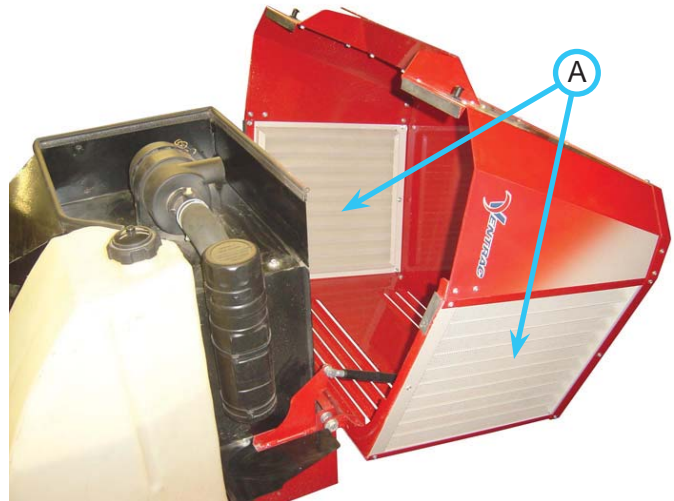

6. Clean all debris from outer screens (A) around the hood with a brush, compressed air, or water. NOTE: be sure to blow or spray from the inside out.

SERVICE

SERVICING AIR FILTER ELEMENTS

⚠ ATTENTION: Avoid engine damage!

- When operating this power unit in extreme heat, dust, or other severe conditions, check the air cleaner daily.
- Never run the engine without the air filter elements installed.
- Do not wash the paper elements.
- Do not attempt to clean the paper elements.
- Do not use pressurized air to clean paper elements.

Primary Air Filter Element

1. Park power unit on a level surface.
2. Shut off engine and engage parking brake.
3. Remove ignition key from switch.
4. Allow engine to cool.
5. Open up engine hood to access engine compartment.
6. Release both spring latches (A) on the canister and unhook latches from the canister housing.
7. Remove the air canister cover (B).
8. Remove and discard the filter element (C).
9. Install the new filter element.
10. Install the air canister cover making sure the word "TOP" is up.
11. Close engine hood.

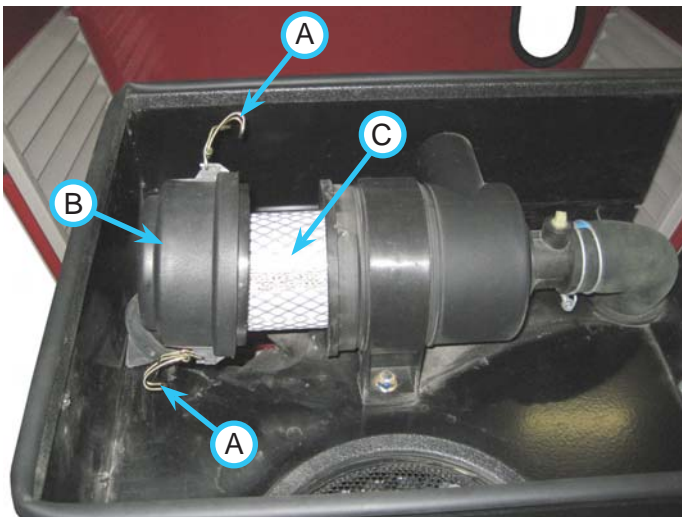

⚠ CAUTION

AVOID ENGINE DAMAGE!

When removing the air filter element, an opening directly to the internal parts of the engine is created. Extreme care should be used when changing this element.

Be sure nothing falls into the canister that could make its way into the engine. Have the new filter element ready to install immediately after the old one is removed.

FILLING THE FUEL TANK

⚠ DANGER

Fuel is flammable and/or explosive. Follow all safety instructions in the Fuel Safety section of this manual and in the engine operator's manual.

⚠ WARNING

Long term exposure to fuel vapors can cause serious injury or illness. Avoid prolonged breathing of fuel vapors.

If fuel is spilled on skin or clothing, change clothing and wash affected skin immediately.

⚠ CAUTION

Avoid damage to your engine!

Only use fuel that meets the specifications required for your engine. Refer to the engine operator's manual for the proper grade and specifications of fuel for your engine.

1. Park the power unit on a level surface.
2. Engage the parking brake and shut off the engine.
3. Remove the key from the ignition switch and allow the engine to cool.
4. Wipe any dust and dirt off the fuel cap to prevent dirt from falling into the fuel tank, and remove the fuel cap.
5. Add fuel to the tank until the fuel level reaches the bottom of the fuel neck*. Do not overfill by filling the fuel neck, as this may cause engine flooding. Keep the fuel nozzle in contact with the rim of the fuel neck until fueling is completed.

*If power unit will not be used after filling fuel tank, only fill the tank to within 1" (25 mm) of the bottom of the fuel neck to allow room for fuel expansion from temperature changes. Failure to do so may cause engine flooding.

SERVICE

6. Replace the fuel cap and tighten.
7. Wipe up any fuel spills and allow fuel vapors to dissipate before starting the engine.

CHANGING THE FUEL FILTER

See engine owner's manual for fuel filter changing instructions. The fuel filter (A) is located at the left rear side of the power unit.



⚠ DANGER

Avoid personal injury and/or death from fumes, fire, or explosion when working on fuel related parts:

- Do not smoke anywhere near the power unit.
- Keep power unit away from flames or sparks.
- Work in a well ventilated area.
- Clean up spilled fuel immediately.
- Let power unit cool before servicing.
- Drain fuel into an approved nonmetallic container.

SERVICE THE BATTERY SAFELY



⚠ CAUTION

Avoid Personal Injury!

Battery electrolyte contains sulfuric acid. It is poisonous and can cause serious burns:

- Wear eye protection and gloves.
- Keep skin protected.
- If electrolyte is swallowed, get medical attention immediately.
- If electrolyte is splashed in eyes, flush immediately with water for 15-30 minutes and get medical attention.
- If electrolyte is splashed onto skin, flush immediately with water and get medical attention, if necessary.

The battery produces a flammable and explosive gas. The battery may explode.

- Do not smoke near battery.
- Wear eye protection and gloves.
- Do not allow direct metal contact across battery posts.
- Remove negative cable first when disconnecting.
- Install negative cable last when connecting.

REMOVING AND INSTALLING BATTERY

Removing:

1. Park power unit on a level surface.
2. Shut off engine and engage parking brake.
3. Remove ignition key from switch.
4. Raise hood.
5. Disconnect negative battery cable (A).
6. Disconnect positive battery cable (B).

SERVICE

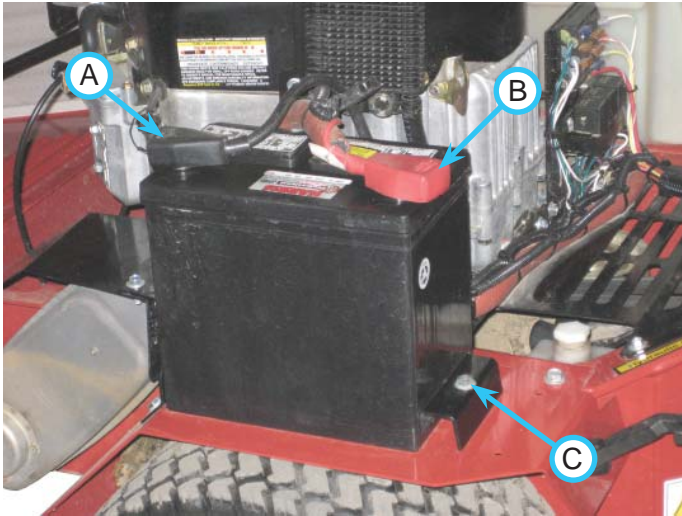

7. Loosen battery clamp fastener (C) and remove the battery clamp.
8. Remove the battery.

Installing:

1. Install battery into the battery compartment.
2. Connect positive cable to positive battery terminal, then connect the negative cable to the negative battery terminal.
3. Apply dielectric grease to terminals to prevent corrosion.
4. Slide terminal covers over battery connections.
5. Install battery clamp over battery and fasten. Do not overtighten.
6. Lower hood.

CLEANING BATTERY AND TERMINALS

1. Park power unit on a level surface.
2. Shut off engine and engage parking brake.
3. Remove ignition key from switch.
4. Disconnect and remove battery.
5. Wash battery with solution of 4 tablespoons of baking soda to 1 gallon (3.8 liters) of water. Be careful not to get the soda solution into the cell.
6. Rinse the battery with clean tap water and dry.
7. Clean terminals and battery cables with wire brush until bright.
8. Apply dielectric grease to terminals to prevent corrosion.

USING A BOOSTER BATTERY

⚠ CAUTION

Avoid Personal Injury!

The battery produces a flammable and explosive gas. The battery may explode.

- Do not smoke near battery.
- Wear eye protection and gloves.
- Do not jump start or charge a cold or frozen battery. Warm battery first.
- Do not connect the negative booster cable to the negative terminal of the discharged battery. Connect at a good ground location on the engine away from the discharged battery.

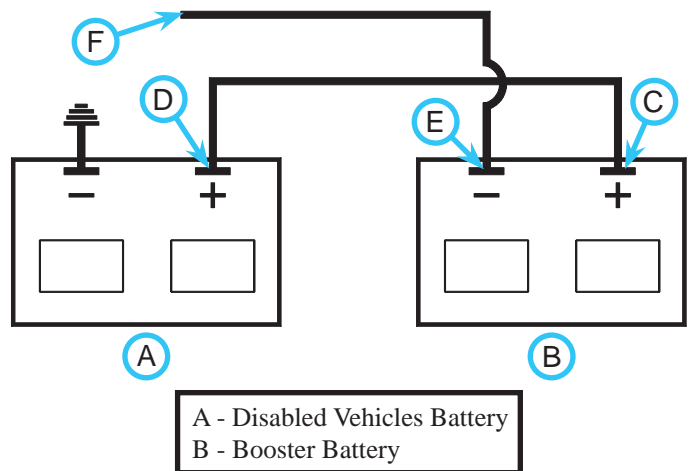

Note: If using a vehicle to boost the battery, boosting vehicle must be shut off.

1. Connect positive booster cable to booster battery positive post (C).
2. Connect the other end of the positive booster cable to the disabled battery's positive post (D).
3. Connect negative booster cable to booster battery negative post (E).
4. Connect the other end (F) of the negative booster cable to a metal part of the disabled power unit's engine block away from the battery.
5. Start the engine of the disabled power unit and run the power unit for several minutes.
6. Carefully disconnect the booster cables in reverse order: negative cable first and then the positive cable.

SERVICE

CHANGING THE HEADLIGHT BULB

CAUTION

Avoid Personal Injury!

The headlight bulb contains gases under pressure. The bulb may shatter if the glass is scratched or dropped. Wear eye protection and handle bulb with care.

1. Park power unit and shut off engine.
2. Engage the parking brake and remove key from the ignition.
3. Remove the two screws (A) clamping the headlight cover on and remove the cover.

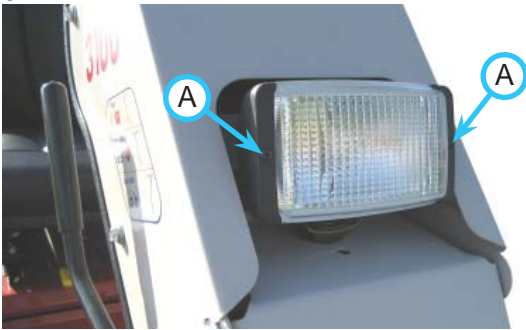

4. Disconnect the ground wire (B) from the defective headlight.
5. Remove wire loom and shrink wrap from positive wire (C) and disconnect the positive wire.

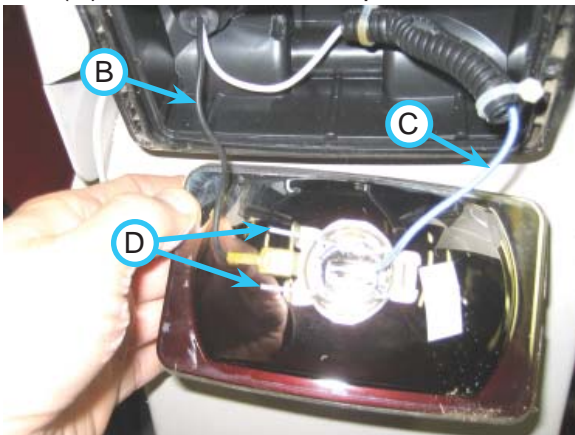

6. Remove the defective headlight from the light assembly by pinching the wire spring fastener (D).
7. Install the new light bulb and secure with spring fastener.
8. Place heat shrink tubing over the positive wire.
9. Reconnect the positive and negative wires as removed.
10. Slide the heat shrink tubing over the connector, apply heat to shrink, and replace the wire loom.
11. Reinstall the headlight cover.

CHANGING THE TAILLIGHTS

1. Park power unit on a level surface.
2. Shut off engine and engage parking brake.
3. Remove ignition key from switch.
4. Disconnect the plug from the back side of the taillight.
5. Push defective taillight assembly out of grommet and discard.
6. Insert the new taillight assembly into the grommet.
7. Plug in the taillight wire as shown in the figure below.



SERVICE

FUSES

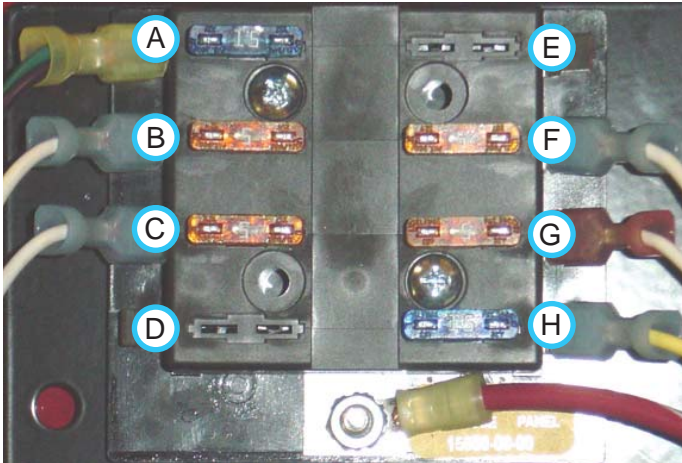

Ref Letter	Circuit	Fuse Size
A	Start/PTO	15
B	PTO Switch	5
C	Engine Relay	5
D	Optional (12 Volt Plugs, Cab)	-
E	Unused	-
F	Alternator	5
G	Dash Panel	5
H	Light Switch	15

CHANGING THE FUSES

1. Park power unit on a level surface.
2. Shut off engine and engage parking brake.
3. Remove ignition key from switch.
4. Identify and pull defective fuse from socket.
5. Push new fuse into socket. Be certain to have the proper size fuse or damage may occur to the power unit.

INSPECTION OF BELTS

Periodically checking the belts on the Ventrac 3100 can prevent sudden failure by finding problems before they cause the belt to break. It is recommended to inspect all belts every 50 hours of operation or if a problem is suspected. There may be a belt problem if there is a squealing or chattering sound, or the smell of a slipping belt.



Typical wear on belts may result in the following conditions as shown in the figure below. If any of these conditions occur, then the belt will require replacement. Refer to the proper replacement section on the following pages for replacing belts.



Glazing



Cracks



Separation



Streaked Sidewalls



Tensile Break

SERVICE

To inspect belts:

1. Park power unit on a level surface.
2. Shut off engine and engage parking brake.
3. Remove ignition key from switch and allow engine to cool.
4. Remove shields A, B, C, and D as shown in the following two images.

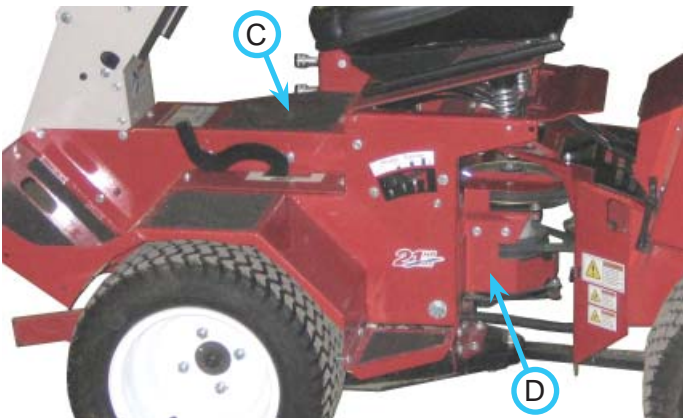
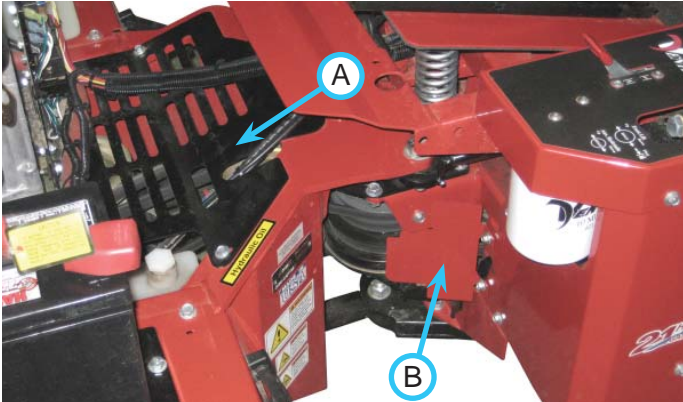

There are four belts that are used on this power unit as shown below. The engine drive belt (E), the rear transaxle belt (F), the front transaxle belt (G), and the PTO drive belt (H).

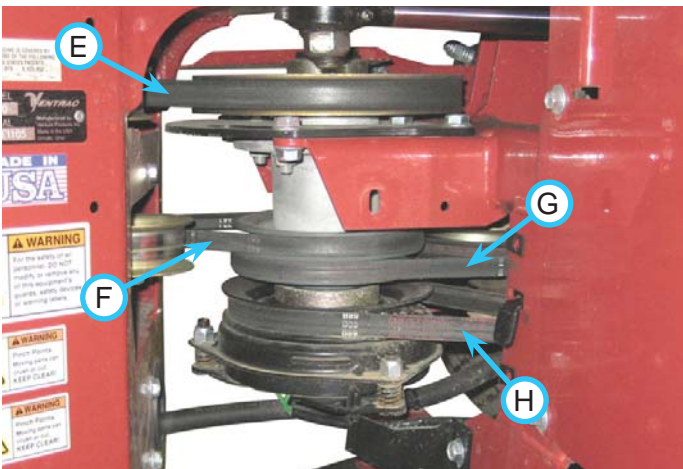

ENGINE DRIVE BELT REPLACEMENT

1. Park power unit on a level surface.
2. Shut off engine and engage parking brake.
3. Remove ignition key from switch and allow engine to cool.
4. Remove shields A, B, and D as shown in the inspection of belts section.
5. Release spring tension from engine drive belt by carefully unhooking tensioner spring from bolt underneath engine plate. The spring may be sprung very tightly.

CAUTION

Avoid Personal Injury

Spring may be under high tension. Use caution when releasing spring as pinching may occur.

6. With tension released from spring, remove belt from the jackshaft pulley first, and then remove from the engine pulley. Slide belt through gap at power unit center pivot (see figure below) and remove. Belt may need twisted 90° to fit between the pulley and the frame.



7. When belt has been removed, install the new belt in the reverse order of removal steps.

SERVICE

PTO BELT REPLACEMENT

1. Park power unit on a level surface.
2. Shut off engine and engage parking brake.
3. Remove ignition key from switch and allow engine to cool.
4. Remove shields B, C, and D as shown in the inspection of belts section. Also remove shield (I) as shown in figure below.

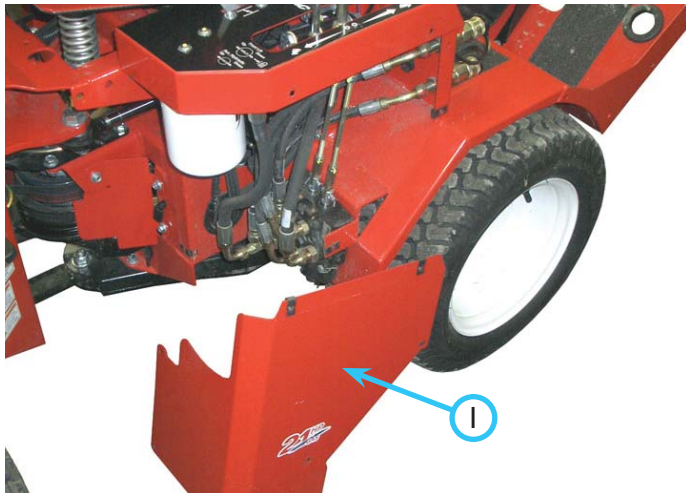

5. Disconnect the PTO clutch wire (J).

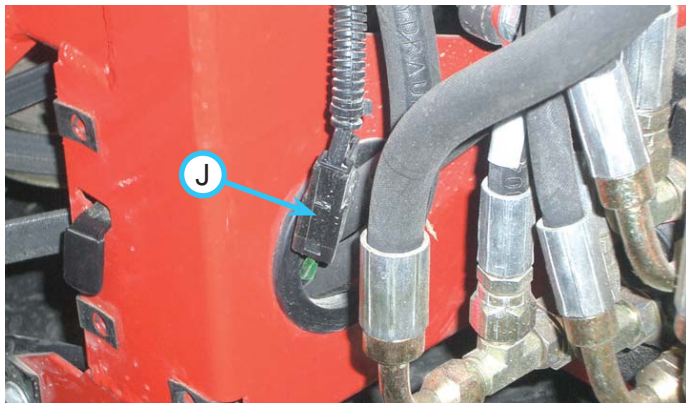

6. Remove the PTO stationary arm (K).

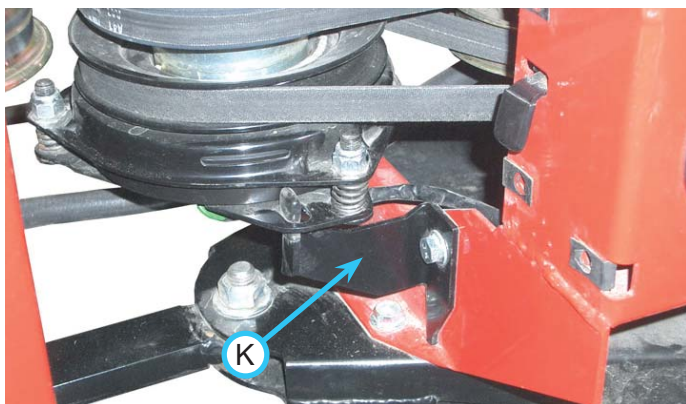

7. Release the tension from the PTO belt by unlatching the two extension arms (L) of the torsion spring that is part of the PTO idler pulley assembly. This is located behind the right front tire (See figure below).

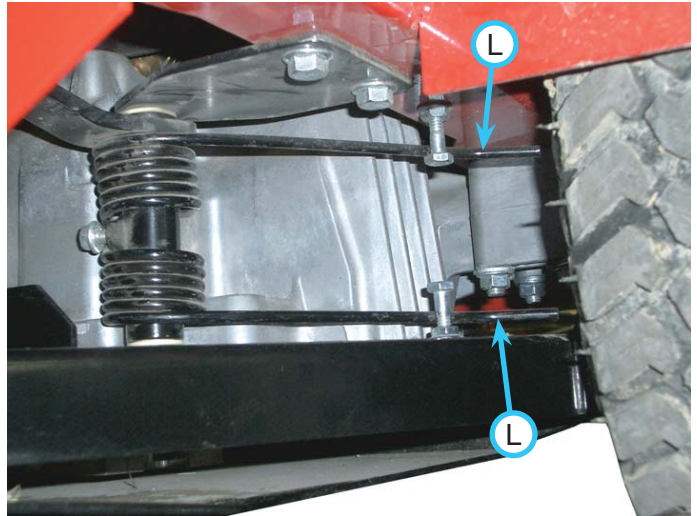

8. Slip the belt off the front double idler pulley and then remove the belt from the PTO clutch.
9. Install the new belt in the reverse order of the removal steps. Be certain that the PTO stationary arm is bolted securely to the frame, and the arm is through the proper mounting hole of the clutch.

SERVICE

TRANSAXLE DRIVE BELT REPLACEMENT

Note: it is recommended to change both transaxle belts at once. The transaxle belts will experience similar wear, and many of the same steps apply to changing both of the belts.

1. Park power unit on a level surface.
2. Shut off engine and engage parking brake.
3. Remove ignition key from switch and allow engine to cool.
4. Remove shields A, B, C, and D as shown in the inspection of belts section.
5. Remove the PTO belt from the clutch. It is not necessary to completely remove the PTO belt from the power unit, just remove the belt from around the clutch. Refer to the PTO belt replacement section to remove the belt from around the PTO clutch.
6. Release the spring tension from both of the transaxle belt tensioners. To locate the transaxle belt tensioners, look for the idler arm pulley that tightens the transaxle. To release the spring tension, carefully unhook the spring extension arm of the idler arm pulley assembly from the power unit.

CAUTION

Avoid Personal Injury

Spring may be under high tension. Use caution when releasing spring as pinching may occur.

7. Remove both of the transaxle drive belts from the power unit.
8. Install the new belts in the reverse order of the removal steps. Note: the rear transaxle drive belt must be installed first because of the belts's location on the jackshaft.

CHECKING HYDRAULIC OIL LEVEL

1. Park power unit on a level surface.
2. Shut off engine and engage parking brake.
3. Remove ignition key from switch and allow engine to cool.
4. Open engine hood to access engine compartment.
5. Locate the hydraulic oil tank (A).



6. Visually inspect to see that the level of hydraulic oil is centered between the low and full marks of the tank. Note: use a flashlight to inspect level, if necessary.
7. If hydraulic oil level is low, remove the cap from the hydraulic tank and add HydroTorq XL synthetic hydraulic oil until level is centered between the low and full marks of the tank.

CHANGING HYDRAULIC OIL AND FILTER

Hydraulic oil and filter should be changed at intervals of 2000 hours. Hydraulic oil and filter to be changed by an authorized Ventrac dealer only.

TIRE PRESSURE

	Turf Tire (Standard)	All Terrain Tire (Optional)
Normal Pressure	9 psi / 62 kPa	9 psi / 62 kPa
Maximum Pressure	20 psi / 140 kPa	22 psi / 150 kPa

SERVICE

VENTRAC 3100 MAINTENANCE SCHEDULE

3100 - Vanguard 21 hp Engine

Maintenance Schedule	3100 - Vanguard 21 hp Engine																												
	# of Locations	# of Pumps	AS NEEDED	After First 25 Hrs.	Daily	At 50 Hours	At 100 Hours	At 150 Hours	At 200 Hours	At 250 Hours	At 300 Hours	At 350 Hours	At 400 Hours	At 450 Hours	At 500 Hours	At 550 Hours	At 600 Hours	At 650 Hours	At 700 Hours	At 750 Hours	At 800 Hours	At 850 Hours	At 900 Hours	At 950 Hours	At 1000 Hours	Yearly	5 Years or 2000 Hrs.		
Grease & Lubrication: See Lubrication Section																													
Front Hitch	2	1	✓		✓	✓	✓	✓	✓	✓	✓	✓	✓	✓	✓	✓	✓	✓	✓	✓	✓	✓	✓	✓	✓	✓	✓	✓	
Lift Cylinder	2	1	✓		✓	✓	✓	✓	✓	✓	✓	✓	✓	✓	✓	✓	✓	✓	✓	✓	✓	✓	✓	✓	✓	✓	✓	✓	
Center Pivot	1	1	✓		✓	✓	✓	✓	✓	✓	✓	✓	✓	✓	✓	✓	✓	✓	✓	✓	✓	✓	✓	✓	✓	✓	✓	✓	
Steering Cylinder End	2	1	✓		✓	✓	✓	✓	✓	✓	✓	✓	✓	✓	✓	✓	✓	✓	✓	✓	✓	✓	✓	✓	✓	✓	✓	✓	
Lower Connector Link	2	1	✓		✓	✓	✓	✓	✓	✓	✓	✓	✓	✓	✓	✓	✓	✓	✓	✓	✓	✓	✓	✓	✓	✓	✓	✓	
Seat Rails	2	#	✓		✓	✓	✓	✓	✓	✓	✓	✓	✓	✓	✓	✓	✓	✓	✓	✓	✓	✓	✓	✓	✓	✓	✓	✓	
Engine¹																													
Check Engine Oil Level				✓																									
Change Engine Oil & Filter ¹			✓		✓	✓	✓	✓	✓	✓	✓	✓	✓	✓	✓	✓	✓	✓	✓	✓	✓	✓	✓	✓	✓	✓	✓	✓	
Clean/Replace Spark Plugs (Gasoline Engines)	Consult Engine Owner's Manual; Follow Service Intervals for Heavy Loads and High Temperatures*																												
Inspect Primary Air Filter			✓																										
Replace Primary Air Filter	**				**	✓	**	✓	**	✓	**	✓	**	✓	**	✓	**	✓	**	✓	**	✓	**	✓	**	✓	**	✓	
Replace Safety Air Filter [@]										✓											✓								
Clean Engine Compartment, Engine, & Outer Hood Screens	**		✓																										
Replace Fuel Filter	✓									✓											✓								
Drain Water & Sediment from Fuel Tank	✓																										✓		
Hydraulic System																													
Check Hydraulic Oil Level			✓																										
Change Hydraulic Oil and Filter																												✓	
Parking Brake																													
Inspect Parking Brake Tension			✓																										
Electrical																													
Replace Light Bulbs	✓																												
Clean Battery Terminals & Compartment	✓																											✓	
Inspection																													
Inspect for Loose, Missing, or Worn Components			✓																										
Inspect Belts, Fuel Lines, and Hydraulic Lines			✓																										
Check Tire Pressure.			✓																										
Check Wheel Lug Nuts. Torque to 85 ft-lbs				✓	✓				✓					✓					✓						✓				
Check Steering Cylinder Bolts. Torque to 140 ft-lbs					✓	✓			✓	✓			✓	✓				✓	✓			✓	✓			✓	✓		
Check Front/Rear Connector Link Bolts. Torque to 140 ft-lbs					✓	✓			✓	✓			✓	✓				✓	✓			✓	✓			✓	✓		
Check Front Hitch Pivot Bolts. Torque to 75 ft-lbs					✓	✓			✓	✓			✓	✓				✓	✓			✓	✓			✓	✓		
* If heavy load, high temperature, or dusty condition service intervals are not specified, Ventrac recommends servicing more frequently at 1/2 the standard service interval.																													
** Operation in severe conditions may require more frequent service intervals.																													
¹ Consult Engine Owner's Manual for engine oil information and complete servicing information																													
[@] Optional Equipment																													
[^] Grease Until Fresh Grease is visible																													
[#] Silicon Based Spray Lubricant																													

TROUBLESHOOTING

ENGINE

SYMPTOM:	POSSIBLE CAUSE:
Engine will not turn over.	Selector lever is not in the park position. PTO switch is engaged. Neutral start switch is out of adjustment. Low voltage battery. Blown fuse in start circuit. Faulty relay in start circuit. Electrical problem in start circuit.
Engine cranks, but won't start.	Insufficient fuel supply. Faulty fuel pump. Plugged fuel filters. Fuel shut off solenoid not working.
Engine runs rough.	Plugged or partially plugged fuel filter. Plugged or partially plugged air filters. Fuel cap vent is plugged or dirty. Stale fuel, dirty fuel, insufficient fuel level. Faulty fuel pump.
Engine is low in power.	Plugged or partially plugged fuel filter. Plugged or partially plugged air filters.
Engine overheats.	Debris in engine, engine compartment, or on outer hood screens.
Oil light comes on when running.	Low in oil. Plugged oil filter. Faulty oil sender. Faulty oil pump.
Engine uses excessive oil.	Incorrect engine oil. Plugged air filter.
Engine emits white exhaust smoke.	Low engine temperature. Allow engine to warm up.
Engine emits black or gray exhaust smoke.	Plugged air intake system. Engine burning oil.
Excessive fuel consumption.	Plugged air intake system. Carburetor not functioning properly.

TROUBLESHOOTING

ELECTRICAL SYSTEM

SYMPTOM:	POSSIBLE CAUSE:
Battery will not charge.	Loose or corroded connections. Broken wire in charge system. Defective battery. Defective alternator. Defective voltage regulator.
Lights won't work.	Blown fuse. Blown light bulb. Broken wire/connection. Faulty light switch.
PTO won't engage.	Faulty seat switch. NOTE: operator must be on seat. Faulty PTO switch. Clutch out of adjustment. Faulty clutch. Electrical problem.

HYDRAULIC SYSTEM

SYMPTOM:	POSSIBLE CAUSE:
Front attachment fails to lift.	Low hydraulic oil. Excessive load on hitch. Faulty hydraulic cylinder.
Steering locks up.	Low hydraulic oil. Faulty steering cylinder.
Excessive noise in hydraulic motors.	Low hydraulic oil. Cold temperature. Allow power unit to warm up.

POWER UNIT

SYMPTOM:	POSSIBLE CAUSE:
Power unit will not move with engine running.	Selector lever not in proper position. Brake is stuck. Low hydraulic oil. Pump control linkage is loose. Transaxle lock out levers are engaged for towing.

SPECIFICATIONS

ENGINE

Manufacture	Vanguard
Model Number385777
Type	Gasoline
Engine Gross HP21
Engine Gross HP	20.1 @ 3200 rpm
Operating Range	1500 - 3200 rpm
Operating Range (European model)	1500 - 3000 rpm
Cooling SystemAir Cooled
Engine Orientation	Vertical Shaft

ELECTRICAL

Battery450 Cold Cranking Amps
Voltage12 Volts
Alternator50 Amp

POWERTRAIN

Type	Hydrostatic (All Wheel Drive)
Hydrostatic Transaxle (2)	Hydro-Gear
Fwd Speed/Rev Speed	7/4 MPH (11/6.5 Km/H)
BrakesHydro-Dynamic
Hydraulic Oil Filtration	10 Micron Spin on Filter

CONTROLS & INSTRUMENT PANEL

Steering	Power
PTO (Power Take Off)	Electric with brake
Throttle Control	Cable
Directional Control	Speed, Direction, Lift, Auxiliary (S.D.L.A.)
Control OrientationHand/Foot
Gauges.	Volt, Hour Meter
Parking/Emergency Brake	Disc

OTHER FEATURES

Turning Radius.28 inches (71 cm)
Drive Tires	Turf (18 x 10.50-10)
.	(46 x 26.67 x 25.4 cm)
Optional Drive TiresKnobby (18 x 11-10)
.	(46 x 28 x 25 cm)
HeadlightHalogen (55 watt)
Attachment System	Minute Mount

SPECIFICATIONS

DIMENSIONS

Wheelbase	38 inches (96.5 cm)
Overall Length	72 inches (183 cm)
Overall Height	47 inches (119 cm)
Overall Width	40-1/2 inches (103 cm)
Weight	850 pounds (385.5 kg)

Venture Products, Inc. reserves the right to change these specifications without notice.

FLUID CAPACITIES

Ventrac 3100 Fluid Capacities		
Engine Oil*	1.5 quarts	1.4 liters
Hydraulic Oil (Front Transaxle & Tank)	5.9 quarts	5.58 liters
Hydraulic Oil (Rear Transaxle)	3 quarts	2.84 liters
Fuel (Unleaded Gasoline)	5.4 gallons	20.44 liters
*When changing both oil and filter.		

A copy of the parts manual and this operator's manual is available at:
<http://ventrac.com/manuals>

[View all manuals](#)



WARRANTY



LIMITED WARRANTY - VENTRAC TURF EQUIPMENT

Venture Products, Inc. (shall be referred to as V.P.I.) warrants on the terms and conditions herein, that it will repair, replace, or adjust any part manufactured by Venture Products Inc. and found by Venture Products Inc. to be defective in material and / or workmanship.

Effective September 1st 2005, Ventrac warranty on power units & attachments (excluding the HG100/HG150 generator) for **residential use only** is limited to **three (3) years** from original purchase date. Ventrac power units & attachments used **commercially or for any income-producing purpose** is limited to **two (2) years** from original purchase date. Ventrac ET200 turbine blower (turbine only) is limited to **two (2) years** from original purchase date. Ventrac HG100/HG150 generator is limited to **one (1) year** from original purchase date. Ventrac power units & attachments used for **rental** is limited to **180 days** from original purchase date. (NOTE: All accessories such as: 3-point hitch, foot pedal, dual wheel kit, etc. will be covered under the above warranty periods as they would apply provided they are installed by an authorized Ventrac dealer.) This warranty may be transferred and will carry the remainder of the warranty starting from the original purchase/registration date with the dealership and/or V.P.I. In the event that product/s originally registered as **(3) year residential use** are to be transferred to a commercial user, the warranty would change to the remainder of **(2) year commercial use** starting from the original purchase/registration date with the dealership and/or V.P.I.

If this warranty covers a consumer product as defined by the Magnusson-Moss warranty act, no warranties, express or implied, (including, but not limited to, the warranty of merchantability or fitness for a particular purpose) shall extend beyond the applicable time period stated in bold face type above.

If this warranty covers a product used commercially or for any income producing purpose, the foregoing warranties are in lieu of all other warranties and no representations, guarantees or warranties, express or implied, (including, but not limited to, a warranty of merchantability or fitness for a particular purpose), are made by V.P.I. in connection with the manufacture or sale of its products.

The engine warranty is covered by its respective engine manufacturer. Please refer to the engine manufacturer's warranty statement that is included in the owner's manual.

The Ventrac turf equipment, including any defective parts, must be returned to an authorized Ventrac dealer within the warranty period. The warranty shall extend to the cost to repair or replace (as determined by V.P.I.) the defective part. **The expense of pickup and delivery of equipment, service call drive time or any transportation expense incurred for warranty repair is the sole responsibility of the owner and is not covered under warranty by Ventrac and/or V.P.I.** V.P.I.'s responsibility in respect to claims is limited to making the required repairs or replacements, and no claim of breach of warranty shall be cause for cancellation or rescission of the contract of sale of any Ventrac equipment. Proof of purchase may be required by the dealer to substantiate any warranty claim. Only warranty work performed and submitted by an authorized Ventrac dealer may be eligible for warranty credit.

This warranty extends only to Ventrac turf equipment operated under normal conditions and properly serviced and maintained. The warranty expressly does **not** cover: (a) any defects, damage or deterioration due to normal use, wear and tear, or exposure; (b) normal maintenance services, such as cleaning, lubrication, oil change; (c) replacement of service items, such as oil, lubricants, spark plugs, belts, rubber hoses or other items subject to normal service replacement; (d) damage or defects arising out of, or relating to abuse, misuse, neglect, alteration, negligence or accident; (e) repair or replacement arising from operation of, or use of the turf equipment which is not in accordance with operating instructions as specified in the operator's manual or other operational instructions provided by V.P.I.; (f) repair or replacement arising as a result of any operation from Ventrac turf equipment that has been altered or modified so as to, in the determination of V.P.I., adversely affect the operation, performance or durability of the equipment or that has altered, modified or affected the turf equipment so as to change the intended use of the product; (g) repair or replacement necessitated by the use of parts, accessories or supplies, including gasoline, oil or lubricants, incompatible with the turf

WARRANTY



LIMITED WARRANTY - VENTRAC TURF EQUIPMENT

equipment or other than as recommended in the operator's manual or other operational instructions provided by V.P.I.; (h) repairs or replacements resulting from parts or accessories which have adversely affected the operation, performance or durability of the turf equipment; or (i) damage or defects due to or arising out of repair of Ventrac turf equipment by person or persons other than an authorized Ventrac service dealer or the installation of parts other than genuine Ventrac parts or Ventrac recommended parts.

The sole liability of V.P.I. with respect to this warranty shall be repair and replacement as set forth herein. V.P.I. shall have no liability for any other cost, loss, or damage. In particular V.P.I. shall have no liability or responsibility for: (i) expenses relating to gasoline, oil, lubricants; (ii) loss, cost, or expense relating to transportation or delivery of turf equipment from the location of owner or location where used by owner to or from any authorized Ventrac dealer; (iii) travel time, overtime, after hours time or other extraordinary repair charges or charge relating to repairs or replacements outside of normal business hours at the place of business of an authorized Ventrac dealer; (iv) rental of like or similar replacement equipment during the period of any warranty repair or replacement work; (v) any telephone or telegram charges; (vi) loss or damage to person or property other than that covered by the terms of this warranty; (vii) any claims for lost revenue, lost profit or additional cost or expense incurred as a result of a claim of breach of warranty; or (viii) attorney's fees.

The remedies of buyer set forth herein are exclusive and are in lieu of all other remedies. The liability of V.P.I., whether in contract, tort, under any warranty, or otherwise, shall not extend beyond its obligation as set forth herein. V.P.I. shall not be liable for cost of removal or installation nor shall V.P.I. be responsible for any direct, indirect, special or consequential damages of any nature. In no event shall V.P.I. be liable for any sum in excess of the price received for the goods for which liability is claimed.

There are no representations or warranties which have been authorized to the buyer of the turf equipment other than set forth in this warranty. Any and all statements or representations made by any seller of this equipment, including those set forth in any sales literature or made orally by any sales representative, are superseded by the terms of this warranty. Any affirmation of fact or promise made by V.P.I. or any of its representatives to the buyer which relates to the goods that are the subject to this warranty shall not be regarded as part of the basis of the bargain and shall not be deemed to create any express warranty that such goods shall conform to the affirmation or promise.

No employee, distributor, or representative is authorized to change the foregoing warranties in any way or grant any other warranty on behalf of V.P.I.

Some states do not allow limitations on how long an implied warranty lasts or allow the exclusion on limitation of incidental or consequential damages, so the above limitation or exclusion may not apply to you.

This warranty gives you specific legal rights, and you may also have other rights which vary from state to state.

This warranty applies to all Ventrac turf equipment sold in the United States and Canada.