



*Operator's Manual
& Parts Drawings*

LM440

Finish Mower

Europe C€ - Serial Number LM440-BC1215 --





500 Venture Drive
Orrville Oh 44667
www.ventrac.com

View all manuals



Visit ventrac.com/manuals for the latest version of this operator's manual.

A downloadable parts manual is also available.

To the Owner Contact Information and Product Identification

If you need to contact an authorized Ventrac dealer for information on servicing your product, always provide the product model and serial numbers.

Please fill in the following information for future reference. See the picture(s) below to find the location of the identification numbers. Record them in the spaces provided.

Date of Purchase: _____

Dealer: _____

Dealer Address: _____

Dealer Phone Number: _____

Dealer Fax Number: _____

Model # (A): _____

Serial # (B): _____

Affix Part/Serial Number label here.



Venture Products Inc. reserves the right to make changes in design or specifications without obligation to make like changes on previously manufactured products.

TABLE OF CONTENTS

INTRODUCTION	PAGE 5
Product Description.....	5
Why Do I Need an Operator’s Manual?	5
Using Your Manual	6
Manual Glossary	6
SAFETY	PAGE 7
Safety Decals	7
General Safety Procedures.....	9
Training Required.....	9
Personal Protective Equipment Requirements	9
Operation Safety	9
Preventing Accidents.....	10
Keep Riders Off.....	10
Operating On Slopes.....	11
Roadway Safety	11
Truck Or Trailer Transport.....	11
Maintenance.....	12
Fuel Safety	12
Hydraulic Safety	13
Cutting Unit Safety	14
OPERATIONAL CONTROLS	PAGE 15
Operational Control Locations.....	15
Main Belt Tensioner (A).....	15
Height Adjustment Handle (B).....	15
GENERAL OPERATION	PAGE 16
Daily Inspection.....	16
Attaching	16
Detaching	16
Mowing and Operating Procedure	16
Transport of Mower	17
Cutting Height Adjustment.....	17
SERVICE	PAGE 18
Cleaning and General Maintenance.....	18
Deck Flip-Up Procedure (Service Position).....	18
Mower Blade Removal & Installation	18
Sharpening Blades.....	18
Deck Belt Inspection	18
Tire Pressure.....	19
Deck Leveling Procedure	19
Lubrication.....	20
Storage.....	20
Maintenance Schedule.....	21
Maintenance Checklist.....	21

TABLE OF CONTENTS

SPECIFICATIONS	PAGE 22
Dimensions	22
Features	22
Noise Emissions.....	23
EC Declaration of Conformity.....	23
PARTS	PAGE 24
Main Deck	24
Carrier Frame.....	26
Front Caster Wheels & Rear Roller.....	28
Hitch Assembly.....	30
Spindles & Blades	32
WARRANTY	PAGE 34

INTRODUCTION



Venture Products Inc. is pleased to provide you with your new Ventrac mower! We hope that Ventrac equipment will provide you with a ONE Tractor Solution.

Product Description

The LM440 mower is designed for the sole purpose of finish mowing and is built to give you maximum performance and productivity. A rugged all steel reinforced carrier frame incorporates a full length rear roller that maximizes grass striping of this ground floating deck.

The LM440 features a 44 inch (112 cm) cutting width. Ventrac's LAS (Linear Adjustment System) provides ten cutting height positions ranging from 1-1/2" (38 mm) to 3-3/4" (95 mm). A single hand adjustment lever allows for a quick change in cutting height selection. A slide release allows the handle to be returned to deck level, preventing it from catching on low branches and shrubs.

With the removal of two pins beneath the cross frame, the deck can be easily tilted to a near vertical position for cleaning, maintenance, or storage.

Why Do I Need an Operator's Manual?

This manual has been created to help you gain the important knowledge of what is needed to safely operate, maintain, and service your machine. It is divided into sections for convenient reference of the appropriate section.

You must read and understand the operator's manual for each piece of Ventrac equipment you own. Reading the operator's manual will help you become familiar with each specific piece of equipment. Understanding the operator's manual will help you, as well as others, avoid personal injury and/or damage to the equipment. Keep this manual with the machine at all times. The manual should remain with the machine even if it is sold. If this manual becomes damaged or unreadable, it should be replaced immediately. Contact your local Ventrac dealer for a replacement.

When using a Ventrac attachment, be sure to read and follow the safety and operating instructions of both the power unit and the attachment being used to ensure the safest operation possible.

The information in this manual provides the operator with the safest procedures to operate the machine while getting the maximum use out of the unit. Failure to follow the safety precautions listed in this manual may result in personal injury and/or damage to the equipment.

INTRODUCTION

Using Your Manual

Throughout this manual, you will encounter special messages and symbols that identify potential safety concerns to help you as well as others avoid personal injury or damage to the equipment.

SYMBOL DEFINITIONS



ATTENTION

This symbol identifies potential health and safety hazards. It marks safety precautions. Your safety and the safety of others is involved.

There are three signal words that describe the level of safety concern: Danger, Warning, and Caution. Safety should always be the #1 priority when working on or operating equipment. Accidents are more likely to occur when proper operating procedures are not followed or inexperienced operators are involved.

Note: Right-Hand and Left-Hand orientations may be referred to at different places throughout this manual. Right-Hand and Left-Hand is determined as if sitting on the power unit seat facing forward.

SIGNAL WORD DEFINITIONS

⚠ DANGER

Indicates an imminently hazardous situation which, if not avoided, will result in death or serious injury. This signal word is limited to the most extreme cases.

⚠ WARNING

Indicates a potentially hazardous situation which, if not avoided, could result in death or serious injury.

⚠ CAUTION

Indicates a potentially hazardous situation which, if not avoided, may result in minor or moderate injury and/or property damage. It may also be used to alert against unsafe practices.

Manual Glossary

Power Unit A Ventrac tractor or other Ventrac engine powered device that may be operated by itself or with an attachment or accessory.

Attachment A piece of Ventrac equipment that requires a Power Unit for operation.

Accessory A device that attaches to a Power Unit or Attachment to extend its capabilities.

Machine Describes any "Attachment" or "Accessory" that is used in conjunction with a power unit.

SAFETY

Safety Decals

The following safety decals must be maintained on your LM440 mower.

Keep all safety decals legible. Remove all grease, dirt, and debris from safety decals and instructional labels. If any decals are faded, illegible, or missing, contact your dealer promptly for replacements.

When new components are installed, be sure that current safety decals are affixed to the replacement components.

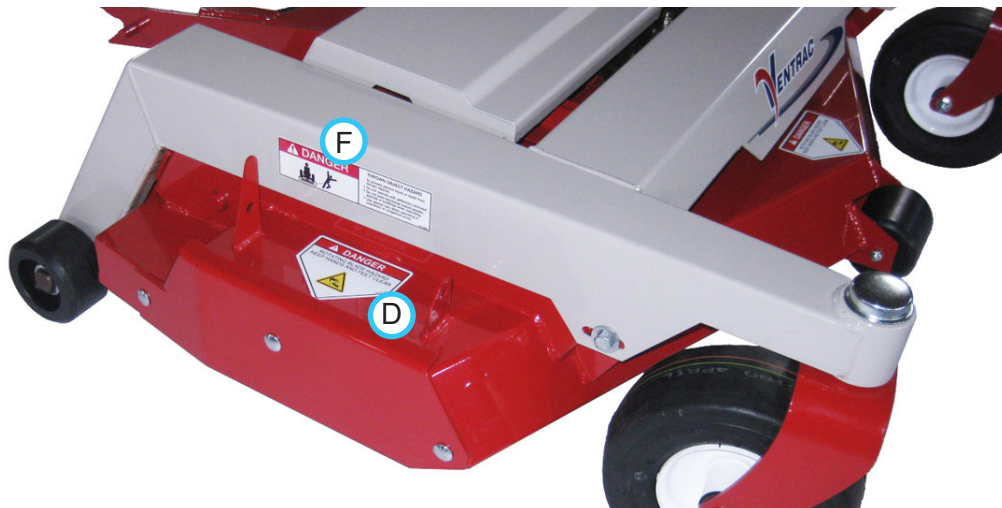
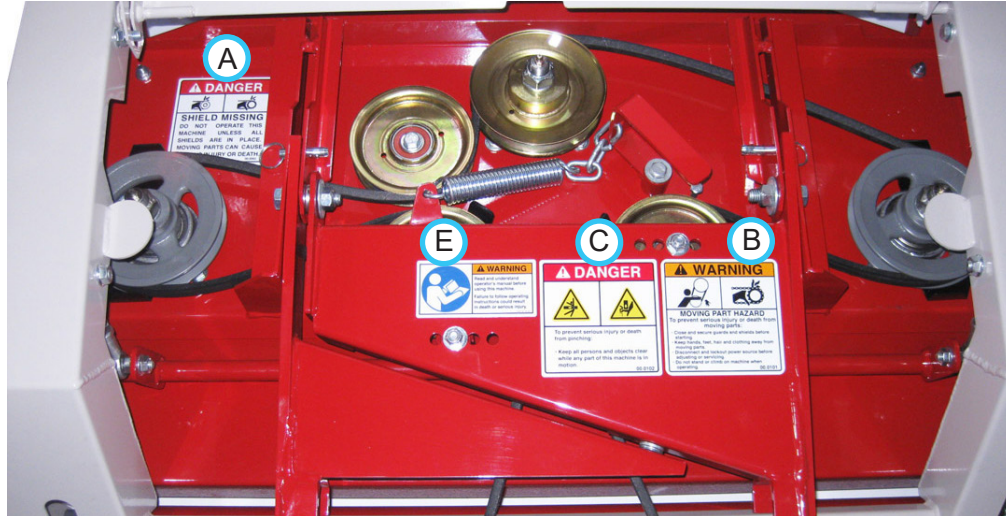

SAFETY

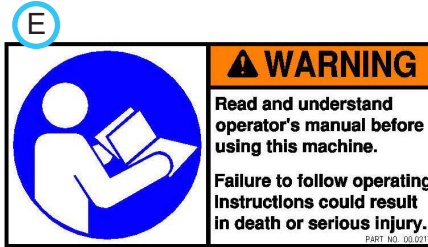
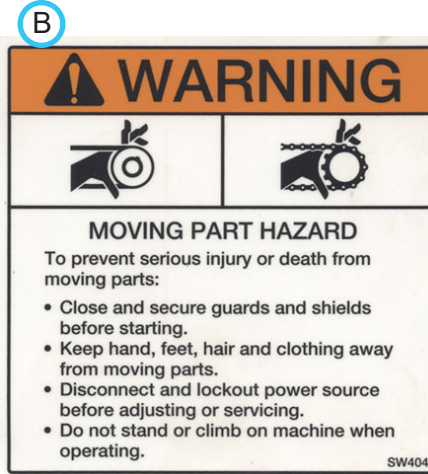

Decal	Description	Part Number	Quantity
A	Danger, Shield Missing	00.0062	1
B	Warning - Moving Part Hazard	00.0101	1
C	Danger, Pinching Hazard	00.0102	1
D	Danger, Keep Hands & Feet Away	00.0123	3
E	Warning, Read Owner's Manual	00.0217	1
F	Danger, Thrown Object Hazard	00.0265	2

SAFETY



General Safety Procedures for Ventrac Power Units, Attachments, & Accessories



Training Required

- The owner of this machine is solely responsible for properly training the operators.
- The owner/operator is solely responsible for the operation of this machine and prevention of accidents or injuries occurring to him/herself, other people, or property.
- Do not allow operation or service by children or untrained personnel. Local regulations may restrict the age of the operator.
- Before operating this machine, read the operator's manual and understand its contents.
- If the operator of the machine cannot understand this manual, then it is the responsibility of this machine's owner to fully explain the material within this manual to the operator.
- Learn and understand the use of all controls.
- Know how to stop the power unit and all attachments quickly in the event of an emergency.



Personal Protective Equipment Requirements

It is the responsibility of the owner to be sure that the operators use the proper personal protective equipment while operating the machine. Required personal protective equipment includes, but is not limited to, the following list.



- Wear a certified ear protection device to prevent loss of hearing.
- Prevent eye injury by wearing safety glasses while operating the machine.
- Closed toe shoes must be worn at all times.
- Long pants must be worn at all times.
- When operating in dusty conditions, it is recommended that a dust mask be worn.

Operation Safety

- Inspect machine before operation. Repair or replace any damaged, worn, or missing parts. Be sure guards and shields are in proper working condition and are secured in place. Make all necessary adjustments before operating machine.
- Some pictures in this manual may show shields or covers opened or removed in order to clearly illustrate any instructions. Under no circumstance should the machine be operated without these devices in place.
- Alterations or modifications to this machine can reduce safety and could cause damage to the machine. Do not alter safety devices or operate with shields or covers removed.
- Before each use, verify that all controls function properly and inspect all safety devices. Do not operate if controls or safety devices are not in proper working condition.
- Check parking brake function before operating. Repair or adjust parking brake if necessary.
- Observe and follow all safety decals.
- All controls are to be operated from the operator's station only.
- Always wear a seat belt if the machine has a roll cage/bar installed and in upright position.
- Ensure the attachment or accessory is locked or fastened securely to the power unit before operating.
- Ensure that all bystanders are clear of the power unit and attachment before operating. Stop machine if someone enters your work area.
- Always be alert to what is happening around you, but do not lose focus on the task you are performing. Always look in the direction the machine is moving.
- Look behind and down before backing up to be sure of a clear path.
- If you hit an object, stop and inspect the machine. Make all necessary repairs before operating machine again.
- Stop operation immediately at any sign of equipment failure. An unusual noise can be a warning of equipment failure or a sign that maintenance is required. Make all necessary repairs before operating machine again.

SAFETY



General Safety Procedures for Ventrac Power Units, Attachments, & Accessories



- If equipped with a high/low range feature, never shift between high and low range while on a slope. Always move the machine to level ground and engage the parking brake before shifting range.
- Do not leave machine unattended while it is running.
- Always park the machine on level ground.
- Always shut off engine when connecting attachment drive belt to the power unit.
- Never leave the operator's station without lowering the attachment to the ground, setting the parking brake, shutting off the engine, and removing the ignition key. Make sure all moving parts have come to a complete stop before dismounting.
- Never leave equipment unattended without lowering the attachment to the ground, setting the parking brake, shutting off the engine, and removing the ignition key.
- Only operate in well-lit conditions.
- Do not operate when there is a risk of lightning.
- Never direct the discharge of any attachment in the direction of people, buildings, animals, vehicles, or other objects of value.
- Never discharge material against a wall or obstruction. Material may ricochet back towards the operator.
- Use extra caution when approaching blind corners, shrubs, trees, or other objects that may obscure vision.
- Do not run the engine in a building without adequate ventilation.
- Do not touch the engine or the muffler while the engine is running or immediately after stopping the engine. These areas may be hot enough to cause a burn.
- Do not change the engine governor settings or over-speed the engine. Operating engine at excessive speed may increase the hazard of personal injury.
- To reduce the hazard of fire, keep the battery compartment, engine, and muffler areas free of grass, leaves, excessive grease, and other flammable materials.

Preventing Accidents



- Clear working area of objects that might be hit or thrown from machine.
- Keep people and pets out of working area.
- Know the work area well before operation. Do not operate where traction or stability is questionable.
- Reduce speed when you are operating over rough ground.
- Equipment can cause serious injury and/or death when improperly used. Before operating, know and understand the operation and safety of the power unit and the attachment being used.

- Do not operate machine if you are not in good physical and mental health, if you will be distracted by personal devices, or are under the influence of any substance which might impair decision, dexterity, or judgment.
- Children are attracted to machine activity. Be aware of children and do not allow them in the working area. Turn off the machine if a child enters the work area.

Keep Riders Off

- Only allow the operator on the power unit. Keep riders off.
- Never allow riders on any attachment or accessory.



SAFETY



General Safety Procedures for Ventrac Power Units, Attachments, & Accessories



Operating On Slopes

- Slopes can cause loss-of-control and tip-over accidents, which can result in severe injury or death. Be familiar with the emergency parking brake, along with the power unit controls and their functions.
- If power unit is equipped with a fold down roll bar, it must be locked in the upright position when operating on any slope.
- Use low range (if equipped) when operating on slopes greater than 15 degrees.
- Do not stop or start suddenly when operating on slopes.
- Never shift between high and low range while on a slope. Always move the power unit to level ground and engage the parking brake before shifting range or placing the power unit in neutral.
- Variables such as wet surface and loose ground will reduce the degree of safety. Do not drive where machine could lose traction or tip over.
- Keep alert for hidden hazards in the terrain.
- Stay away from drop-offs, ditches, and embankments.
- Sharp turns should be avoided when operating on slopes.
- Pulling loads on hills decreases safety. It is the responsibility of the owner/operator to determine loads that can safely be controlled on slopes.
- Transport machine with attachment lowered or close to the ground to improve stability.
- While operating on slopes, drive in an up and down direction when possible. If turning is necessary while driving across slopes, reduce speed and turn slowly in the downhill direction.
- Assure a sufficient supply of fuel for continuous operation. A minimum of one-half tank of fuel is recommended.

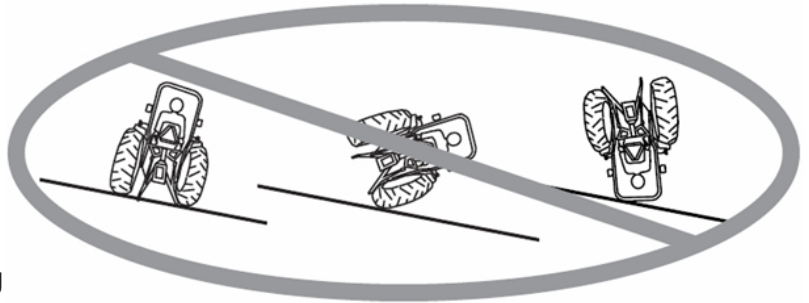

Roadway Safety

- Operate with safety lights when operating on or near roadways.
- Obey all state and local laws concerning operation on roadways.
- Slow down and be careful of traffic when operating near or crossing roadways. Stop before crossing roads or sidewalks. Use care when approaching areas or objects that may obscure vision.
- If there is doubt of safety conditions, discontinue machine operation until a time when operation can be performed safely.
- When operating near or on roadways, have a Slow Moving Vehicle Emblem clearly displayed.

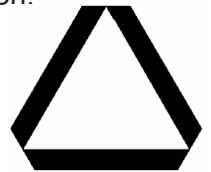

Truck Or Trailer Transport

- Use care when loading or unloading machine into a truck or trailer.
- Use full width ramps for loading machine into a truck or trailer.
- The parking brake is not sufficient to lock the machine during transport. Always secure the power unit and/or attachment to the transporting vehicle securely using straps, chains, cable, or ropes. Both front and rear straps should be directed down and outward from the machine.
- Shut off fuel supply to power unit during transport on truck or trailer.
- If equipped, turn the battery disconnect switch to the Off position to shut off electrical power.

SAFETY



General Safety Procedures for Ventrac Power Units, Attachments, & Accessories



Maintenance

- Keep all safety decals legible. Remove all grease dirt, and debris from safety decals and instructional labels.
- If any decals are faded, illegible, or missing, contact your dealer promptly for replacements.
- When new components are installed, be sure that current safety decals are affixed to the replacement components.
- If any component requires replacement, use only original Ventrac replacement parts.
- Always turn the battery disconnect to the Off position or disconnect the battery before performing any repairs. Disconnect the negative terminal first and the positive terminal last. Reconnect the positive terminal first and the negative terminal last.
- Keep all bolts, nuts, screws, and other fasteners properly tightened.
- Always lower the attachment to the ground, engage parking brake, shut off engine, and remove the ignition key. Make sure all moving parts have come to a complete stop before cleaning, inspection, adjusting or repairing.
- If the power unit, attachment, or accessory requires repairs or adjustments not instructed in the operator's manual, the power unit, attachment, or accessory must be taken to an authorized Ventrac dealer for service.
- Never perform maintenance on the power unit and/or attachment if someone is in the operator's station.
- Always use protective glasses when handling the battery.
- Check all fuel lines for tightness and wear on a regular basis. Tighten or repair them as needed.
- To reduce the hazard of fire, keep the battery compartment, engine, and muffler areas free of grass, leaves, and excessive grease.
- Do not touch the engine, the muffler, or other exhaust components while the engine is running or immediately after stopping the engine. These areas may be hot enough to cause a burn.
- Allow the engine to cool before storing and do not store near an open flame.
- Do not change the engine governor settings or over-speed the engine. Operating engine at excessive speed may increase the hazard of personal injury.
- Springs may contain stored energy. Use caution when disengaging or removing springs and/or spring loaded components.
- An obstruction or blockage in a drive system or moving/rotating parts may cause a buildup of stored energy. When the obstruction or blockage is removed, the drive system or moving/rotating parts may move suddenly. Do not attempt to remove an obstruction or blockage with your hands. Keep hands, feet, and clothing away from all power-driven parts.
- Dispose of all fluids in accordance with local laws.

Fuel Safety



- To avoid personal injury or property damage, use extreme care in handling gasoline. Gasoline is extremely flammable and the vapors are explosive.
- Do not refuel machine while smoking or at a location near flames or sparks.
- Always refuel the machine outdoors.
- Do not store machine or fuel container indoors where fumes or fuel can reach an open flame, spark, or pilot light.
- Only store fuel in an approved container. Keep out of reach of children.
- Never fill containers inside a vehicle or on a truck or trailer bed with a plastic liner. Always place containers on the ground away from your vehicle before filling.
- Remove machine from the truck or trailer and refuel it on the ground. If this is not possible, refuel the machine using a portable container, rather than from a fuel dispenser nozzle.
- Never remove fuel cap or add fuel with the engine running. Allow engine to cool before refueling.
- Never remove fuel cap while on a slope. Only remove when parked on a level surface.
- Replace all fuel tank and container caps securely.

SAFETY



General Safety Procedures for Ventrac Power Units, Attachments, & Accessories



Fuel Safety (continued)

- Do not overfill fuel tank. Only fill to bottom of fuel neck, do not fill fuel neck full. Overfilling of fuel tank could result in engine flooding, fuel leakage from the tank, and/or damage to the emissions control system.
- If fuel is spilled, do not attempt to start the engine. Move the power unit away from the fuel spill and avoid creating any source of ignition until fuel vapors have dissipated.
- If the fuel tank must be drained, it should be drained outdoors into an approved container.
- Dispose of all fluids in accordance with local laws.
- Check all fuel lines for tightness and wear on a regular basis. Tighten or repair them as needed.
- The fuel system is equipped with a shut-off valve. Shut off the fuel when transporting the machine to and from the job, when parking the machine indoors, or when servicing the fuel system.

Hydraulic Safety

- Make sure all hydraulic connections are tight and all hydraulic hoses and tubes are in good condition. Repair any leaks and replace any damaged or deteriorated hoses or tubes before starting the machine.
- Hydraulic leaks can occur under high pressure. Hydraulic leaks require special care and attention.
- Use a piece of cardboard and a magnifying glass to locate suspected hydraulic leaks.



- Keep body and hands away from pinhole leaks or nozzles that eject high pressure hydraulic fluid. Hydraulic fluid escaping under high pressure can penetrate the skin causing serious injury, leading to severe complications and/or secondary infections if left untreated. If hydraulic fluid is injected into the skin, seek immediate medical attention no matter how minor the injury appears.

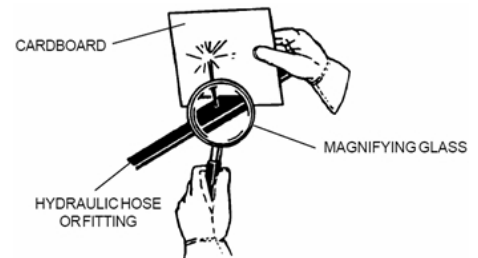

- Hydraulic system may contain stored energy. Before performing maintenance or repairs on the hydraulic system, remove attachments, engage parking brake, disengage weight transfer system (if equipped), shut off engine, and remove ignition key. To relieve pressure on the auxiliary hydraulic system, shut off the power unit engine and move the hydraulic control lever left and right before disconnecting the auxiliary hydraulic quick couplers.
- Dispose of all fluids in accordance with local laws.

SAFETY



LM440 Safety Procedures



Cutting Unit Safety

- Rotating Blades: Contact with the rotating mower blades or other moving parts may cause personal injury. Keep hands and feet away.
- Rotation of one blade may cause another blade to rotate.
- Thrown Object Hazard: Do not point discharge toward people, animals, or buildings when operating. Never operate with the deflectors removed.
- When not mowing, always shut off the PTO to stop the mower blades.
- Never raise the mower deck with the blades running.



OPERATIONAL CONTROLS

Operational Control Locations

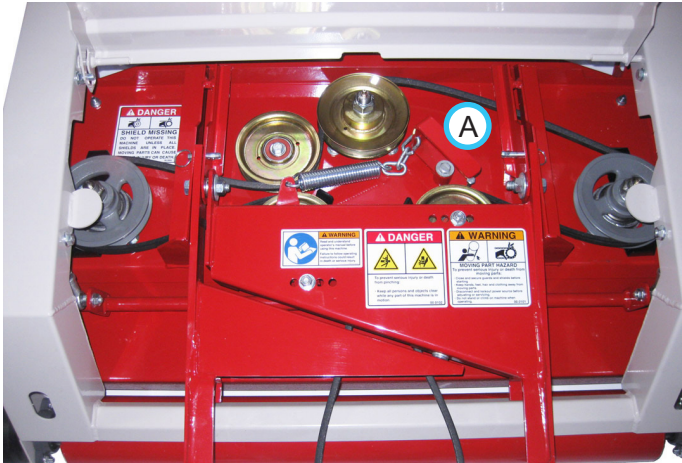

Height Adjustment Handle (B)

The height adjustment handle is used to raise or lower the deck to achieve the desired cutting height.



A - Main Belt Tensioner

B - Height Adjustment Handle

Main Belt Tensioner (A)

Rotating the main belt tensioner clockwise until it locks applies tension to the attachment drive belt. Rotating the main belt tensioner counter-clockwise releases tension on the attachment drive belt, allowing the operator to remove or install the attachment drive belt onto the power unit.

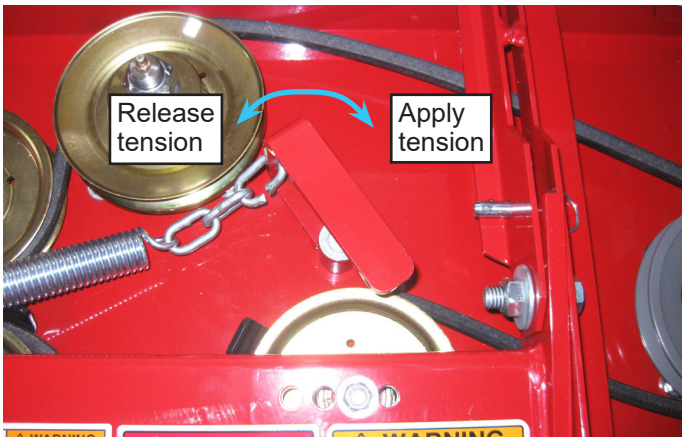

GENERAL OPERATION

Daily Inspection

⚠ WARNING

Always set the parking brake, shut off the power unit engine, remove the ignition key, and ensure all moving parts have stopped before checking mower deck or blade condition, or attempting any repair or adjustment.

1. Park the power unit and mower deck on a level surface, with the engine shut off and all fluids cold.
2. Perform a visual inspection of the power unit and mower deck. Look for loose or missing hardware, damaged components, or signs of wear. Inspect hydraulic hoses, hydraulic fittings, and fuel lines to ensure tight, leak free connections.
3. Refer to the power unit operator's manual. Check the power unit's engine oil, hydraulic oil, cooling system, tire pressure, and fuel level. Add fluid or service system as required.
4. Inspect the drive belts and mower blades. Belts should be in good condition. Blades should be sharp and securely fastened. Service as required.
5. Refer to the power unit operator's manual. Test the power unit's operator safety interlock system.

Attaching

1. Drive the power unit slowly forward into the hitch arms of the mower deck. Align the lift arms of the power unit with the mower hitch arms by raising or lowering the front hitch and complete the engagement.
2. Once completely engaged, close the front hitch locking lever.*
3. Engage the parking brake* and shut off the engine.
4. Place the attachment belt onto the PTO drive pulley on the power unit. Ensure the deck belt is properly routed and engaged in each pulley.
5. Engage the main belt tensioner. NOTE: if deck is raised to the top position, the deck shield will interfere with the belt tensioner.
6. Always check to ensure the deck belt is properly located in each pulley groove before attempting to operate.

Detaching

1. Park the power unit on a level surface and set the parking brake.*
2. Lower the mower deck to the ground.
3. Shut off power unit engine.

4. Raise the mower deck to the highest cutting height position for easy reattachment.
5. Disengage the main belt tensioner.
6. Remove the attachment belt from the PTO drive pulley of the power unit.
7. Disengage the hitch locking lever.*
8. Restart the power unit and slowly back away from the mower. A side to side movement of the steering wheel may aid disengagement.

Mowing and Operating Procedure

Before operation, perform daily inspection and confirm that the cutting height is set properly. Set the power unit's weight transfer system* (if equipped) to the desired setting.

With the power unit engine running between 2,000 and 2,500 RPM, engage the PTO switch. Adjust the throttle to the desired engine RPM.

Lower the mower deck to the ground and place the power unit's primary S.D.L.A. control lever in the float position by pushing it to the right until the detent engages. The lever will stay in this position until intentionally removed.

Begin forward motion in the desired path of mowing. Avoid obstacles, removing debris as necessary.

A stripe pattern in the grass is produced when each mowing pass is done in the opposite direction of the pass beside it. This look is enhanced by the full length roller, which helps to roll the grass in the direction of travel.

Lift the mower deck when the edge of the mowing area is reached. Turn the power unit and mower around and align for the next pass.

⚠ WARNING

Always shut off the engine, remove the ignition key, and set the parking brake before checking mower deck or blade condition, or attempting any repair or adjustment.

Blades should be kept in good condition. Sharp blades will increase efficiency and improve the quality of cut.

Mowing in wet conditions may result in a build up of clippings under the deck. Periodic checking should be done by the operator to determine if the deck should be cleaned. The deck should also be checked any-time mowing performance seems to be reduced.

* Refer to power unit operator's manual for operation of power unit controls.

GENERAL OPERATION

Transport of Mower

Transport the mower deck with the power unit front hitch and mower fully raised to reduce wear of the equipment. Travel slowly when transporting over undulating and rough surfaces to maintain control of power unit and to reduce the shock to the power unit and mower deck. Always disengage the power unit PTO before transporting the mower.

Cutting Height Adjustment

⚠ WARNING

Always shut off the engine, remove the ignition key, and set the parking brake before checking mower deck or blade condition, or attempting any repair or adjustment.

1. Lift the height adjustment handle upward and hook the lock pin into the notch (A) on the height setting control bracket.

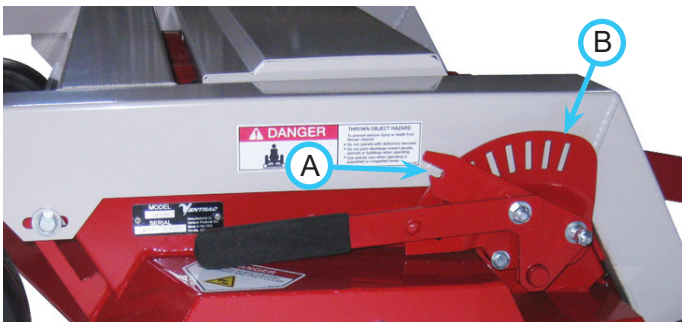

2. Pull the handle outward to release the catch from the height adjust selector plate (B) .
3. Rotate the height adjustment handle up or down until the desired setting is reached.
4. When the desired cutting height is reached, release the height adjustment tab into the proper slot on the selector plate.
5. Lift the height adjustment handle free of the height setting control bracket and rotate down to lay on the deck.

SERVICE

⚠ WARNING

Always shut off the engine, remove the ignition key, and set the parking brake before checking mower deck or blade condition, or attempting any repair or adjustment.



Attention

If any component requires replacement, use only original Ventrac replacement parts.

Cleaning and General Maintenance

For best results, and to maintain the finish of the mower, clean or wash the mower to remove accumulated clippings, leaves, and dirt when the job is finished. Refer to the "Deck Flip-up procedure" in the service section to access the underside of the deck. If washing the deck, do not spray directly into bearings or seals. After washing, it is important to run the mower so that water does not reside on seals of bearings for the drive system. When washing is complete, return the deck to the operating position and activate the PTO for 30 seconds to remove any standing water.

Deck Flip-Up Procedure (Service Position)

1. Park the power unit and mower deck on a smooth, level surface.
2. Raise the power unit front hitch to its highest position.
3. Set the parking brake, shut off the engine, and remove the ignition key.
4. Adjust the mower deck height to the lowest cutting height position.
5. Lift the mower deck shield and remove the 2) ball pins (A) that lock the hitch arms from pivoting.



6. Lift the mower deck up to a near vertical position

and reinstall the ball pins to lock the deck in the upright position.

7. To return the deck to the operating position, remove the 2) ball pins and lower the deck to the ground. Reinstall the ball pins and lower the mower deck shield into place.

Mower Blade Removal & Installation

⚠ CAUTION

Mower blades may be sharp. Always wear safety glasses, leather gloves, and a long sleeve shirt when working with mower blades.

1. Rotate the mower deck up to the service position following the deck flip-up procedure.
2. Place a short piece of 2 x 4 wood between the end of the blade and an appropriate structural part of the underside of the deck to prevent the blade from rotating.
3. Loosen the blade bolt counterclockwise and remove the blade for sharpening or replacement.
4. When installing a blade, the wood block must be placed on the opposite side to prevent rotation for tightening the blade bolt.
5. Tighten the blade bolt to 75-80 ft. lbs.

Sharpening Blades

Blades should be sharpened and balanced by a professional. Maintain balance, same bevel, and length of sharpened surface.

Deck Belt Inspection

Inspecting the drive belts of the mower can prevent sudden belt failure by finding problems before they cause a belt to break. Typical wear on a drive belt may result in the conditions shown in the diagram.

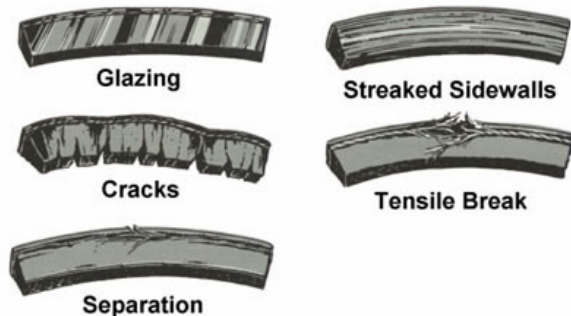

If any of these conditions occur, the drive belt will require replacement.

SERVICE

Deck Belt Replacement

1. Detach the mower deck from the power unit.
2. Raise the mower deck shield.
3. Remove the old deck belt.
4. Install the new deck belt. Place belt into the pulley system according to the belt diagram located on the underside of the mower deck shield.

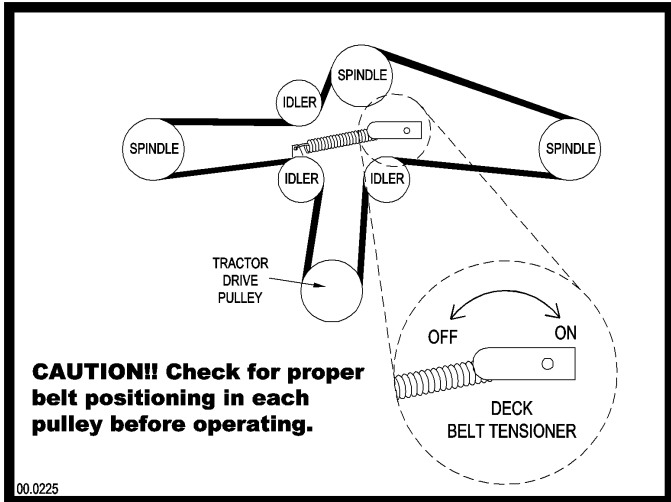

5. Ensure the belt is engaged in the groove of each spindle pulley and around each of the flat idler pulleys.

Tire Pressure

On mower decks equipped with pneumatic (inflatable) tires, the tire pressure should be maintained at 6-8 psi. Pressure variance between left and right tires can cause an uneven cut.

On mower decks with equipped with flat-free tires, no tire pressure adjustments are required. The flat-free cushioning tires provide a maintenance free, consistent cutting height.

Deck Leveling Procedure

CAUTION

Mower blades may be sharp. Always wear safety glasses, leather gloves, and a long sleeve shirt when working with mower blades.

1. Place the mower on a hard surface that is clean and level. Detach the mower from the power unit.
2. Raise the mower deck to the highest cutting height setting.
3. Block the tires and rear roller to prevent the mower from rolling during leveling procedure.
4. Ensure both front tires are inflated to the recommended tire pressure (See Tire Pressure section).

WARNING

Place blocks under 4) corners of the deck when reaching under the mower deck to prevent the deck from accidentally dropping and trapping or crushing a bodily appendage.

5. Check the mower blades to ensure they are not bent. To check for bent blades, move one blade tip to the back of the deck and measure from the floor to the blade. Rotate the other blade tip to the back of the deck and measure again. If the distance is different, the blade is bent and should be replaced before continuing.

6. Go to one side of the deck. Turn the blade so the tip is at the back of the deck. Measure the distance from the floor to the blade.

7. Move to the other side of the mower deck and turn that blade tip to the back of the deck. If this measures differently from the first side, adjust the threaded rod linkage (A) directly above on the top side of the deck until the measurement is the same as the first side.

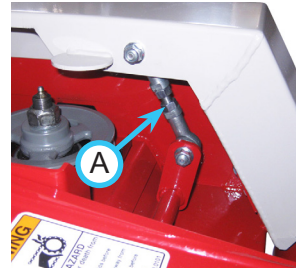

8. Once the deck has been level side to side, rotate the same blade tip to the front of the deck and measure. The distance from the floor to the blade should be the same to 1/8" lower than the rear measurement.

9. If the front of the deck requires adjustment, loosen the cross bolts (B) in the carrier frame. Move the bolts forward in the slots to lower the deck or move the bolts rearward in the slots to raise the deck. NOTE: slight movement of the bolt in the front carrier slots will make a significant difference in the front deck height.

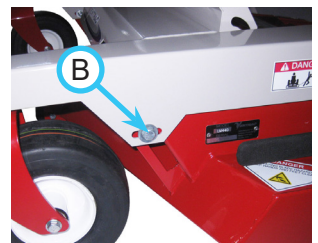

SERVICE

Lubrication

Lubrication is required at the following locations. Use a lithium complex NLGI #2 type grease. Refer to the maintenance schedule for service intervals.

When greasing the rear roller bearings, if the carrier frame is not equipped with access holes, flip the mower deck up into the service position (See Deck Flip-Up Procedure section) and raise the mower deck to the highest cutting height setting to access the grease fittings.

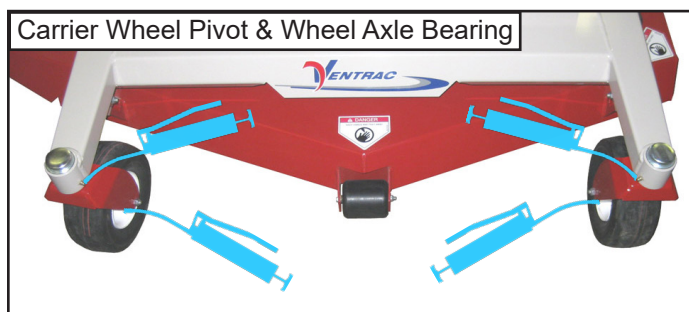
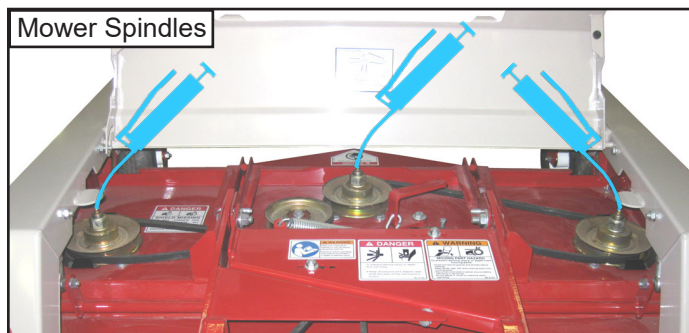
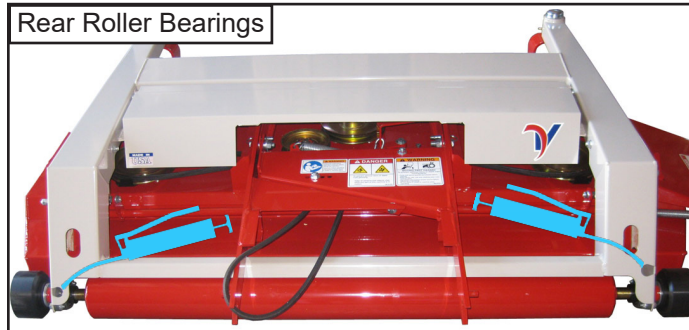

Storage

Preparing the Mower for Storage

1. Clean the mower deck and frame.
2. Inspect for loose or missing hardware, damaged components, or signs of wear. Repair or replace any damaged or worn components
3. Inspect belts, spindles, and blades. Repair or replace any damaged or worn components
4. Apply grease to all grease points.
5. Wipe off all excess grease or oil.

Removing the Mower from Storage

1. Clean the mower deck to remove any accumulated dust or debris.
2. Inspect the mower deck as instructed in the daily inspection section of this manual.
3. Test the mower deck to ensure all components are working properly.

SERVICE

Maintenance Schedule

LM440

Maintenance Schedule	# of Locations	# of Pumps	AS NEEDED	Daily	At 50 Hours	At 100 Hours	At 150 Hours	At 200 Hours	At 250 Hours	At 300 Hours	At 350 Hours	At 400 Hours	At 450 Hours	At 500 Hours	At 550 Hours	At 600 Hours	At 650 Hours	At 700 Hours	At 750 Hours	At 800 Hours	At 850 Hours	At 900 Hours	At 950 Hours	At 1000 Hours	Yearly	
																										Grease & Lubrication: See Lubrication Section
Caster Wheel Pivot	2	1			✓	✓	✓	✓	✓	✓	✓	✓	✓	✓	✓	✓	✓	✓	✓	✓	✓	✓	✓	✓	✓	✓
Wheel Axle Bearing	2	^	**		✓	✓	✓	✓	✓	✓	✓	✓	✓	✓	✓	✓	✓	✓	✓	✓	✓	✓	✓	✓	✓	✓
Rear Roller Bearing	2	1			✓	✓	✓	✓	✓	✓	✓	✓	✓	✓	✓	✓	✓	✓	✓	✓	✓	✓	✓	✓	✓	✓
Spindle	3	3			✓	✓	✓	✓	✓	✓	✓	✓	✓	✓	✓	✓	✓	✓	✓	✓	✓	✓	✓	✓	✓	✓
Deck Slide	4	%	**		✓	✓	✓	✓	✓	✓	✓	✓	✓	✓	✓	✓	✓	✓	✓	✓	✓	✓	✓	✓	✓	✓
Inspection																										
Inspect for Loose, Missing, or Worn Components.				✓																						
Inspect Belts, Pulleys, Blades, and Blade Retaining Bolts				✓																						
Check Tire Pressure, If Applicable				✓																						
Check Hitch Pivot Bolts. Torque to 75 ft-lbs.					✓		✓		✓		✓		✓		✓		✓		✓		✓		✓		✓	
Inspect Safety Decals				✓																						
** Operation in severe conditions may require more frequent service intervals.																										
^ Grease until fresh grease is visible.																										
% Clean and relubricate with a thin film of grease.																										

Maintenance Checklist

LM440

Maintenance Checklist	# of Locations	# of Pumps	AS NEEDED	Daily	At 50 Hours	At 100 Hours	At 150 Hours	At 200 Hours	At 250 Hours	At 300 Hours	At 350 Hours	At 400 Hours	At 450 Hours	At 500 Hours	At 550 Hours	At 600 Hours	At 650 Hours	At 700 Hours	At 750 Hours	At 800 Hours	At 850 Hours	At 900 Hours	At 950 Hours	At 1000 Hours	Yearly	
																										Grease & Lubrication: See Lubrication Section
Caster Wheel Pivot	2	1																								
Wheel Axle Bearing	2	^	**																							
Rear Roller Bearing	2	1																								
Spindle	3	3																								
Deck Slide	4	%	**																							
Inspection																										
Inspect for Loose, Missing, or Worn Components.																										
Inspect Belts, Pulleys, Blades, and Blade Retaining Bolts																										
Check Tire Pressure, If Applicable																										
Check Hitch Pivot Bolts. Torque to 75 ft-lbs.																										
Inspect Safety Decals																										
** Operation in severe conditions may require more frequent service intervals.																										
^ Grease until fresh grease is visible.																										
% Clean and relubricate with a thin film of grease.																										

SPECIFICATIONS

Dimensions

Overall Height	13 inches (33 cm)
Overall Length	42 inches (107 cm)
Overall Width45 inches (114 cm)
Weight220 pounds (100 kg)
Cutting Width44 inches (112 cm)
Approximate Cutting Height Range	1-1/2 - 3-3/4 inches (3.8 - 9.5 cm)
Number of Cutting Positions	10 positions
Number of Blades	3 blades

Features

- Flip-up Deck
- Single Lever Linear Adjustment System
- Field Serviceable Spindles
- Full Floating Deck

SPECIFICATIONS

Noise Emissions^{1,2,3}

Measured Sound Power Level, dB(A)	98.3
Sound Power Uncertainty, dB(A)	1.6
Sound Pressure Level at Operator's Ear, dB(A)	83.8
Sound Pressure Uncertainty, dB(A)	1.4

Note 1: Noise emission levels for the LM440 mower include noise emissions from the 3200 power unit.

Note 2: Noise emissions determined per EN ISO 11201:2009.

Note 3: Specifications subject to change without notice.

EC Declaration of Conformity

Ventrac LM440

Manufacturer	Venture Products, Inc. 500 Venture Drive Orrville, OH 44667 – USA
Authorized Representative (also authorized to compile the technical file)	Lars Persson LAPAB MASKIN AB Box 46, S-734 22 Hallstahammar Flädervägen 5, 734 38 Hallstahammar SWEDEN
Technical File Keeper	Ryan Steiner Venture Products, Inc. 500 Venture Drive Orrville, OH 44667 – USA
Description	Finish mowing attachment
Model Name	Ventrac LM440 Mower
Model Number	39.35104
Serial Number	LM440-Bxxxxx
This Product Conforms to Directives	2006/42/EC
This Product Conforms to Standards	EN 836
Ryan Steiner Director of Engineering 	16-July-2015 Orrville, Ohio – USA

PARTS

ILLUSTRATED DRAWING

Main Deck

TWO PIECE DECK SHOWN TOGETHER

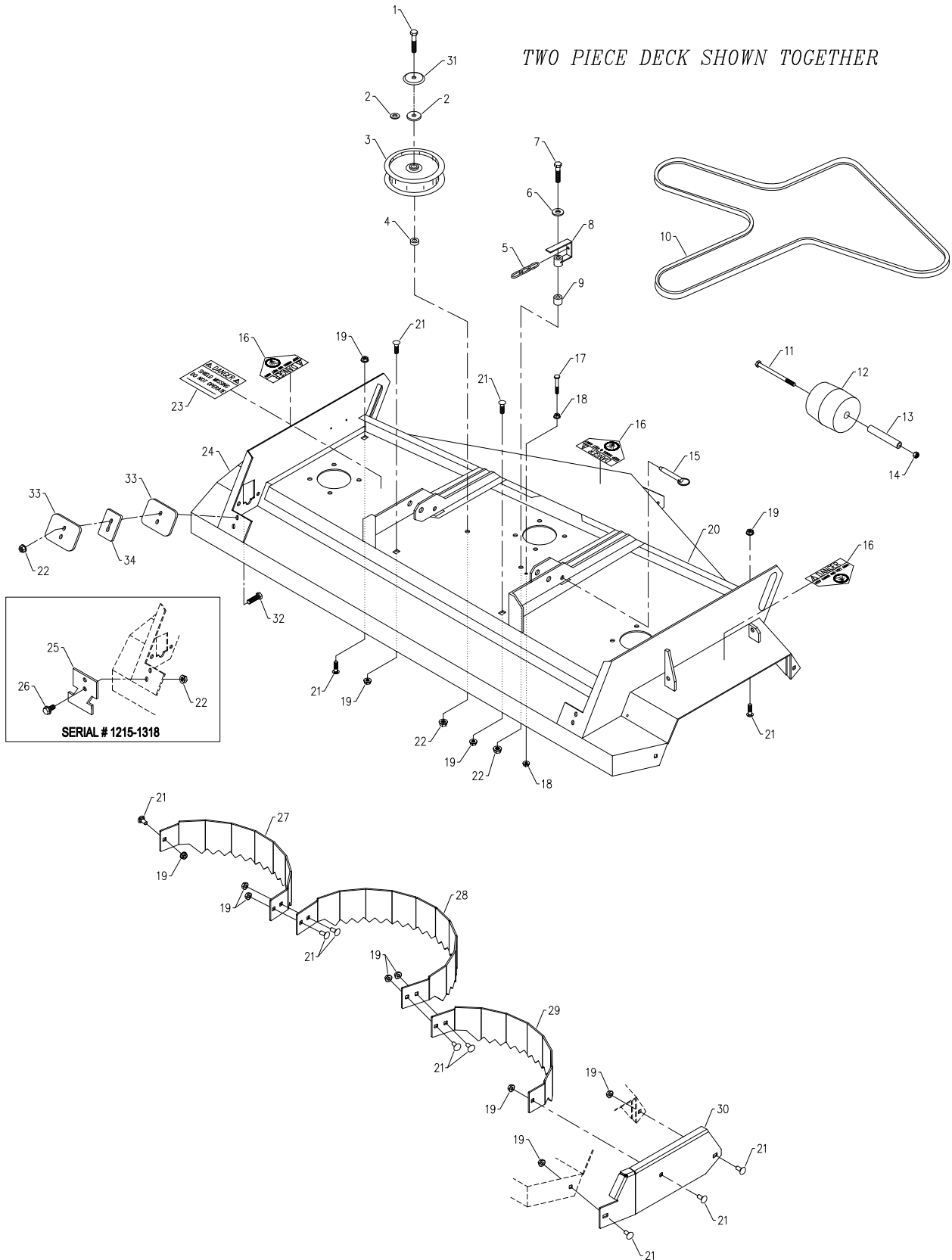

PARTS

Main Deck

REF.	PART NO.	DESCRIPTION	QTY.
1	90.0616	.BOLT, 3/8-16 USS X 2	1
2	95.06	.WASHER, FLAT 3/8 SAE (Serial # 1215-1269)	1
2	99.G0014	.WASHER, 3/8 USS FW .165 THK (Serial # 1270-1328)	1
3	83.0037	.PULLEY, IDLER FLAT 4" X 3/8	1
4	85.SC06	.SET COLLAR, 3/8"	1
5	81.0131	.CHAIN, 3/16 PLATED 3 LINKS	1
6	94.06	.WASHER, FLAT 3/8 USS	1
7	90.0614	.BOLT, 3/8-16 USS X 1 3/4	1
8	42.0417	.TENSIONER, MAIN BELT TIGHTNER	1
9	64.0797	.BUSHING, 7/16 X 3/4 X 1-1/16L	1
10	81.A115	.BELT, A115	1
11	90.0536	.BOLT, 5/16-18 USS X 4 1/2	1
12	50.0047	.ROLLER, FRONT 3" DIA X 3 1/2"	1
13	50.0046	.TUBE, AXLE FRONT ROLLER	1
14	99.A05	.LOCKNUT, STOVER 5/16-18 USS	1
15	03.0006	.PIN, BALL 3/8 X 1"	2
16	00.0123	.DECAL, KEEP HANDS & FEET CLEAR	3
17	90.0414	.BOLT, 1/4-20 USS X 1 3/4	1
18	99.SF04	.NUT, SRF 1/4-20 USS	2
19	99.SF05	.NUT, SRF 5/16-18 USS	12
20	62.0917	.FRAME, TOP DECK PLATE	1
21	97.0506	.BOLT, CARRIAGE 5/16 X 3/4	12
22	99.SF06	.NUT, SRF 3/8-16 USS	6
23	00.0062	.DECAL, DANGER SHIELD MISSING	1
24	62.0919	.DECK, MAIN WELDMENT	1
25	64.0669	.BRACKET, REAR SLIDE PLATES (Serial # 1215-1318)	2
26	99.SF0606	.BOLT, SRF 3/8-16 USS X 3/4 (Serial # 1215-1318)	4
27	64.0972	.RING, MULCHING LEFT	1
28	64.0974	.RING, CENTER MULCHING	1
29	64.0973	.RING, MULCHING RIGHT	1
30	60.0824	.PLATE, RIGHT END	1
31	60.1056	.COVER, PULLEY (Serial # 1270-)	1
32	90.0610	.BOLT, 3/8-16 USS X 1-1/4 (Serial # 1319-)	4
33	64.1179	.PLATE, REAR SLIDE RETAINER (Serial # 1319-)	4
34	64.1181	.SPACER, REAR SLIDE (Serial # 1319-)	2

PARTS

ILLUSTRATED DRAWING Carrier Frame

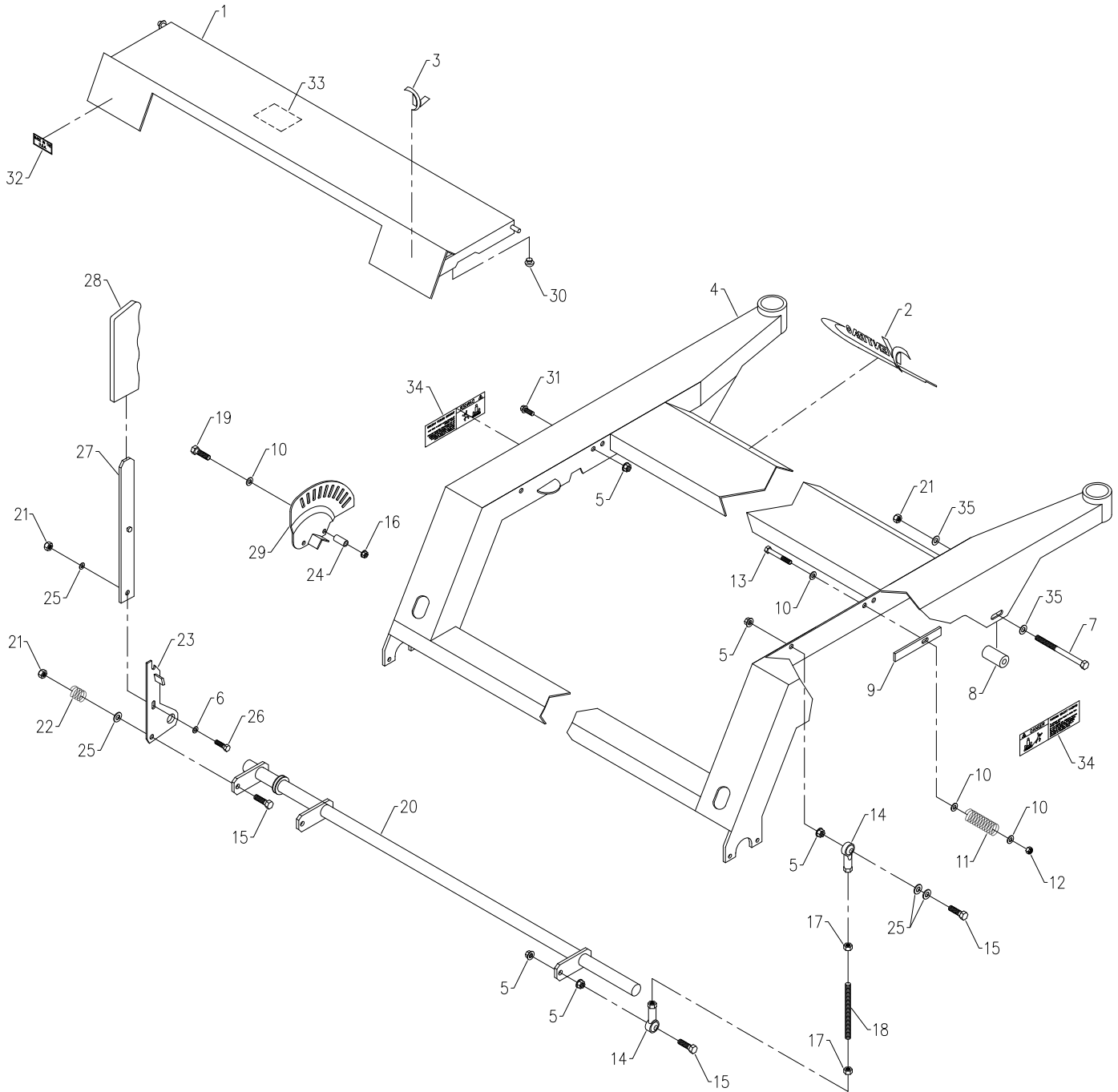

PARTS

Carrier Frame

REF.	PART NO.	DESCRIPTION	QTY.
1	60.0823	.SHIELD, MOWER DECK	1
2	00.0189	.DECAL, VENTRAC ORBITAL	1
3	00.0192	.DECAL, V-DECAL DIE CUT BLUE	1
4	62.0918	.FRAME, MAIN CARRIER	1
5	99.SF06	.NUT, SRF 3/8-16 USS	8
6	94.06	.WASHER, FLAT 3/8 USS	4
7	90.0620	.BOLT, 3/8-16 USS X 2 1/2	2
8	64.0798	.BUSHING, 7/16 X 3/4 X 1-1/2L	2
9	64.0682	.BRACKET, SHIELD SPRING	1
10	95.05	.WASHER, FLAT 5/16 SAE	5
11	41.0021	.SPRING, COMP 1/2 OD X 2-3/4 LG	1
12	99.A05	.LOCKNUT, STOVER 5/16-18 USS	1
13	90.0524	.BOLT, 5/16-18 USS X 3	1
14	43.006	.ROD END, 3/8 SPHERICAL	4
15	90.0612	.BOLT, 3/8-16 USS X 1 1/2	5
16	99.SF05	.NUT, SRF 5/16-18 USS	2
17	93.06	.NUT, 3/8-24 SAE	4
18	99.J0620NF	.ROD, THREADED 3/8-24 X 2-1/2L	2
19	90.0514	.BOLT, 5/16-18 USS X 1 3/4	2
20	42.0446	.SHAFT, HEIGHT ADJUST CROSSBAR	1
21	99.A06	.LOCKNUT, STOVER 3/8-16 USS	5
22	41.0039	.SPRING, COMP. 9/16 OD X 5/8	1
23	64.0795	.BRACKET, HT SETTING CONTROL	1
24	64.0799	.BUSHING, PIPE 1/4 X 1-1/8L	2
25	95.06	.WASHER, FLAT 3/8 SAE	6
26	90.0608	.BOLT, 3/8-16 USS X 1	1
27	40.0267	.LEVER, HEIGHT ADJUSTMENT	1
28	47.0086	.GRIP, SLIP-ON HANDLE - BLACK	1
29	64.0796	.PLATE, HEIGHT ADJUST INDEX	1
30	05.0062	.BUMPER, NEOPRENE 18-12 GA	2
31	99.SF0608	.BOLT, SRF 3/8-16 USS X 1	1
32	00.0100	.DECAL, MADE IN USA	1
33	00.0225	.DECAL, BELT DIAGRAM LM	1
34	00.0265	.DECAL, THROWN OBJECT HAZARD	2
35	99.G0014	.WASHER, 3/8 USS FW .165 THK	4

PARTS

ILLUSTRATED DRAWING Front Caster Wheels & Rear Roller

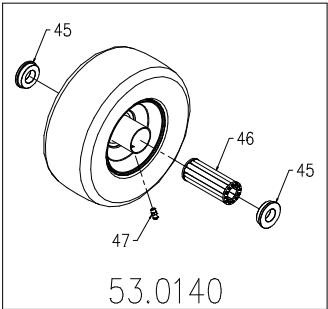
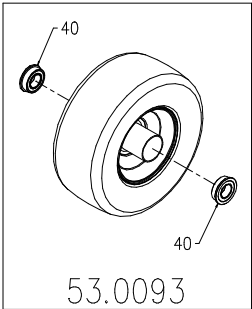
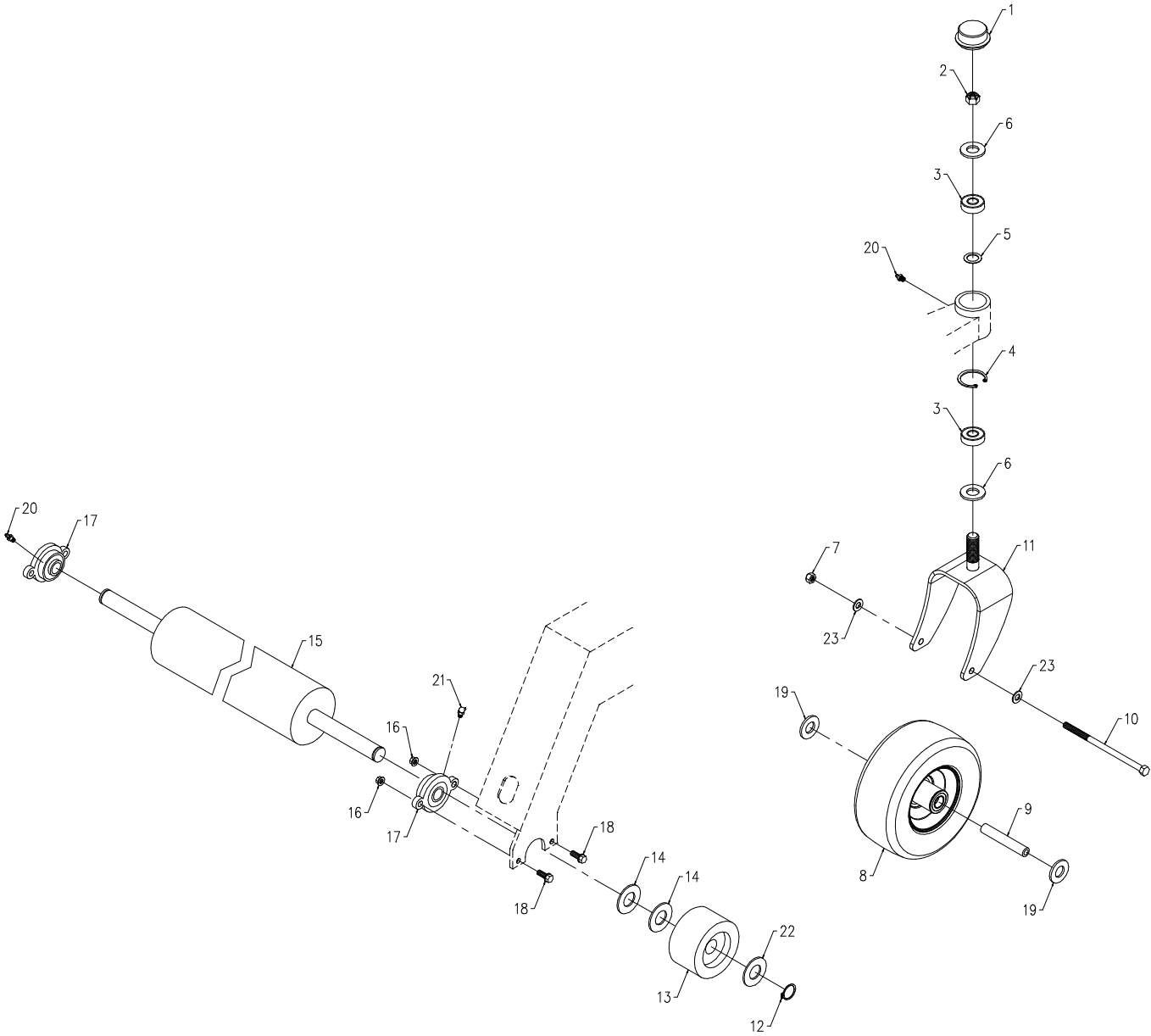

PARTS

Front Caster Wheels & Rear Roller

REF.	PART NO.	DESCRIPTION	QTY.
1	53.0080	.DUST CAP, BEARING MOWER CASTER	2
2	99.A12NF	.LOCKNUT, STOVER 3/4-16 SAE	2
3	55.0023	.BEARING, BALL .75 ID X 1.78 OD	4
4	04.0013	.SNAP RING, INT .062 X 1.75	2
5	99.B0052	.SHIM, STEEL 3/4 X 1 X .062	2
6	99.B0057-2	.WASHER, MACH3/4 X1-1/4 10GA ZP	4
7	99.A06N	.LOCKNUT, NYLON 3/8-16	2
8	53.0093	.WHEEL, ASM 9 X 3.50 X4 SMOOTH (Serial # 1215-1250)	2
8	53.0140	.WHEEL, ASM 9 X 3.5 X4 FLATFREE (Serial # 1251-)	2
9	50.0055	.TUBE, AXLE-WHEEL LM	2
10	90.0644	.BOLT, 3/8-16 USS X 5 1/2	2
11	50.0185	.SPINDLE, TIRE SWIVEL 9"	2
12	04.0016	.SNAP RING, EXT.1 SHFT .042 THK (Serial # 1215-1238)	2
12	04.0025	.SNAP RING, EXT.1 SHFT .078 THK (Serial # 1239-)	2
13	50.0056	.ROLLER, END 4" OD X 2.69" LONG	2
14	95.16	.WASHER, FLAT 1 SAE	4*
15	80.0319	.ROLLER, 4" REAR	1
16	99.SF05	.NUT, SRF 5/16-18 USS	4
17	55.FB16016	.BEARING, FLANGE BLOCK 1" REGGF	2
18	99.SF0508	.BOLT, SRF 5/16-18 USS X 1	4
19	95.12	.WASHER, FLAT 3/4 SAE	4*
20	29.GF0001	.GREASE FTG, 1/4 SAE ST	3
21	29.GF0002	.GREASE FTG, 1/4 SAE 90	1
22	99.B0093	.WASHER, 1" ID X 1-1/2" OD 10GA	2
23	95.06	.WASHER, FLAT 3/8 SAE	4
40	55.0060	.BEARING, DOUBLE-SEALED	2
45	55.0072	.BEARING, RETAINER 3/4"	2
46	55.0071	.BEARING, ROLLER 3.25" LONG	1
47	29.GF0001	.GREASE FTG, 1/4 SAE ST	1

* as required

PARTS

Hitch Assembly

REF.	PART NO.	DESCRIPTION	QTY.
1	62.0833	.HITCH, RIGHT ARM	1
2	62.0834	.HITCH, LEFT ARM	1
3	40.0266	.ARM, IDLER MAIN DRIVE BELT	1
4	90.0816	.BOLT, 1/2-13 USS X 2	1
5	94.08	.WASHER, FLAT 1/2 USS	4
6	85.SC08	.SET COLLAR, 1/2"	3
7	90.0814	.BOLT, 1/2-13 USS X 1 3/4	1
8	99.A08	.LOCKNUT, STOVER 1/2-13 USS	2
9	64.0722	.BUSHING, STEEL 0.438 X 0.875	1
10	83.0037	.PULLEY, IDLER FLAT 4" X 3/8	2
11	60.0726	.BRACKET, IDLER BELT RETAINER	2
12	95.06	.WASHER, FLAT 3/8 SAE	11
13	90.0614	.BOLT, 3/8-16 USS X 1 3/4	2
14	90.0620	.BOLT, 3/8-16 USS X 2 1/2 (Serial # 1215-1269)	1
14	90.0622	.BOLT, 3/8-16 USS X 2 3/4 (Serial # 1270-)	1
15	99.A06	.LOCKNUT, STOVER 3/8-16 USS	3
16	00.0101	.DECAL, HAZARD-MOVING PART	1
17	99.SF06	.NUT, SRF 3/8-16 USS	1
18	41.0048	.SPRING, EXT. 1 OD X 6	1
19	90.0610	.BOLT, 3/8-16 USS X 1 1/4	1
20	00.0102	.DECAL, DANGER-PINCHING HAZARD	1
21	64.0797	.BUSHING, 7/16 X 3/4 X 1-1/16L	1
22	94.06	.WASHER, FLAT 3/8 USS	1
23	00.0217	.DECAL, WARNING READ OWNERS MAN	1
24	95.06	.WASHER, FLAT 3/8 SAE (Serial # 1215-1269)	1
24	60.1056	.COVER, PULLEY (Serial # 1270-)	1
25	60.1056	.COVER, PULLEY (Serial # 1270-)	1

PARTS

ILLUSTRATED DRAWING Spindles & Blades

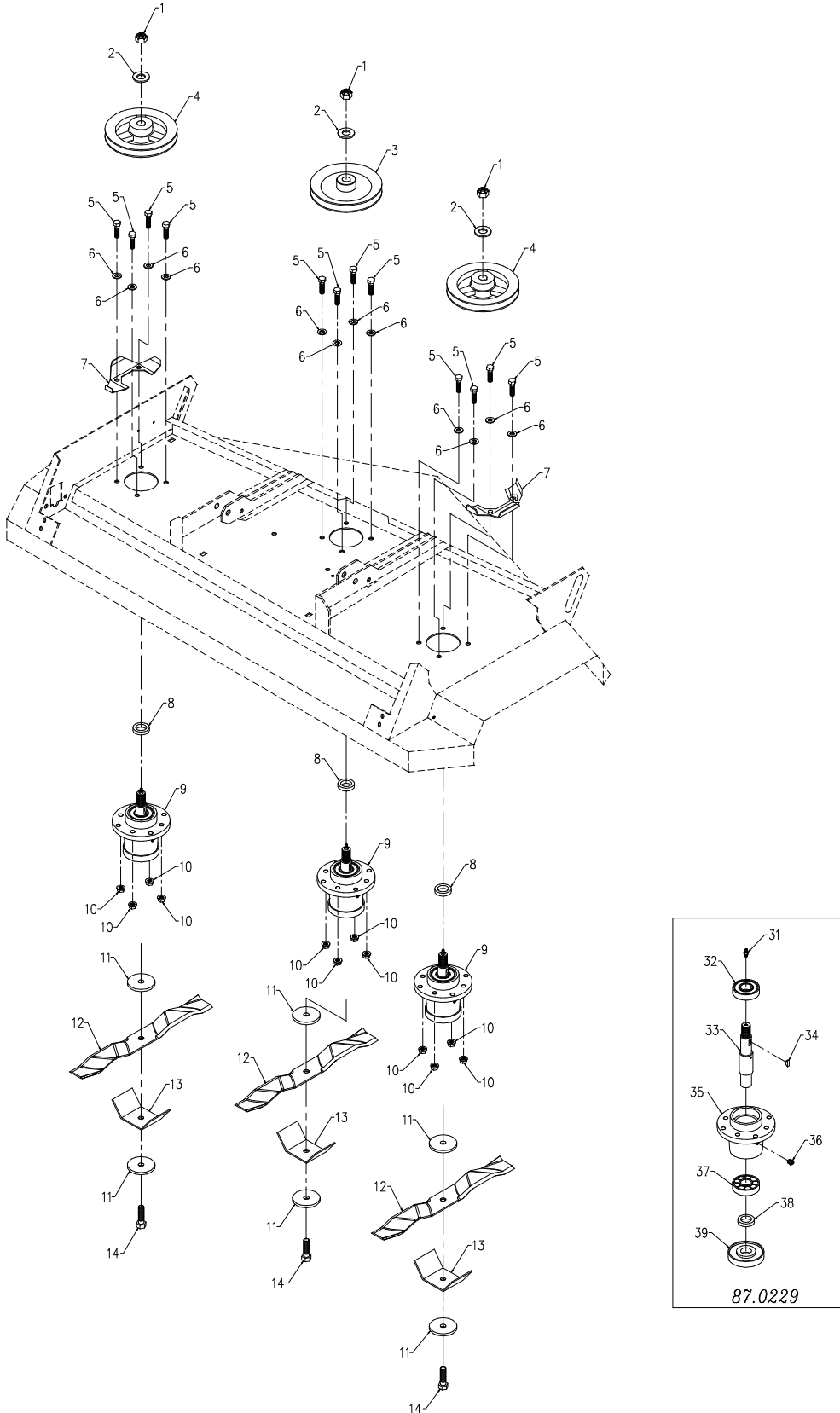

PARTS

Spindles & Blades

REF.	PART NO.	DESCRIPTION	QTY.
1	99.A12NF	.LOCKNUT, STOVER 3/4-16 SAE	3
2	99.B0057-2	.WASHER, MACH3/4 X1-1/4 10GA ZP	3
3	83.0050	.PULLEY, 5-1/8, 25 MM STR. BORE	1
4	83.BK5725M	.PULLEY, 5.7" 25MM BORE 1/4 KEY	2
5	90.0612	.BOLT, 3/8-16 USS X 1 1/2	12
6	95.06	.WASHER, FLAT 3/8 SAE	12
7	60.0725	.BRACKET, BELT RETAINER	2
8	85.B0080	.BUSHING, 1-1/2 OD, 1 ID	3
9	87.0229	.SPINDLE, ASM RH 25MM AL	3
10	99.E0082	.NUT, LOCKING FLANGE 3/8-16	12
11	99.B0091	.WASHER, .510 ID X 2-1/2 OD 1/4	6
12	79.0060	.BLADE, 15.00X1/2 RH F MULCH	3
13	64.2002	.GUARD, SPINDLE/ANTI-STRING	3
14	91.0814-8	.BOLT, 1/2-20 X 1-3/4 GR8	3
31	29.GF0001	.GREASE FTG, 1/4 SAE ST	1
32	55.0057	.BEARING, BALL 25 MM X 62 MM	1
33	87.0209-2	.SHAFT, SPINDLE RH	1
34	85.W0406	.KEY, WOODRUFF 1/4 X 3/4	1
35	87.0209-1	.HOUSING, SPINDLE AL	1
36	29.GF0017	.RELIEF FITTING	1
37	55.0035	.BEARING, BALL 25 MM X 62 MM	1
38	85.B0082	.BUSHING, SPINDLE SHAFT SPACER	1
39	87.0210	.SPINDLE, FLANGE SHIELD	1

WARRANTY



LIMITED WARRANTY - VENTRAC COMMERCIAL EQUIPMENT

Venture Products, Inc., (henceforth referred to as V.P.I.) warrants on the terms and conditions herein, that it will repair, replace, or adjust any part manufactured by Venture Products Inc., and found by Venture Products, Inc., to be defective in material and/or workmanship during the applicable warranty term.

All Ventrac commercial equipment purchased and registered on or after January 1, 2019 will carry a 2-year commercial warranty. The warranty period begins on the date of original customer purchase:

Ventrac Commercial Equipment	Warranty Term
2100 SSV & Attachments	2-year
3000 Series Tractors & Attachments	2-year
4000 Series Tractors & Attachments	2-year

All Ventrac add-on kits and accessories such as: 3-point hitch, 12V front & rear power outlets, foot pedal, dual wheel kit, etc., will be covered under the above warranty periods provided they are installed by an Authorized Ventrac Dealer. This warranty may be transferred and will carry the remainder of the warranty starting from the original purchase/registration date with the dealership and/or V.P.I.

The engine warranty is covered by its respective engine manufacturer. Please refer to the engine manufacturer's warranty statement that is included in the owner's manual.

For warranty consideration on Ventrac commercial equipment, including any defective part, must be returned to an Authorized Ventrac Dealer within the warranty period. The warranty shall extend to the cost to repair or replace (as determined by V.P.I.) the defective part. The expense of pickup and delivery of equipment, service call drive time or any transportation expense incurred for warranty repair is the sole responsibility of the owner and is not covered under warranty by Ventrac and/or V.P.I. Ventrac and V.P.I.'s responsibility in respect to claims is limited to making the required repairs or replacements, and no claim of breach of warranty shall be cause for cancellation or rescission of the contract of sale of any Ventrac equipment. Proof of purchase may be required by the dealer to substantiate any warranty claim. Only warranty work performed and submitted by an Authorized Ventrac Dealer may be eligible for warranty credit.

This warranty extends only to Ventrac commercial equipment operated under normal conditions and properly serviced and maintained. The warranty expressly does NOT cover: (a) any defects, damage or deterioration due to normal use, wear and tear, or exposure; (b) normal maintenance services, such as cleaning, lubrication, oil change; (c) replacement of service items, such as oil, lubricants, spark plugs, belts, rubber hoses, bearings or other items subject to normal service replacement; (d) damage or defects arising out of, or relating to abuse, misuse, neglect, alteration, negligence or accident; (e) repair or replacement arising from operation of, or use of the equipment which is not in accordance with operating instructions as specified in the operator's manual or other operational instructions provided by V.P.I.; (f) repair or replacement arising as a result of any operation from Ventrac equipment that has been altered or modified so as to, in the determination of V.P.I., adversely affect the operation, performance or durability of the equipment or that has altered, modified or affected the equipment so as to change the intended use of the product; (g) repair or replacement necessitated by the use of parts, accessories or supplies, including gasoline, oil or lubricants, incompatible with the equipment or other than as recommended in the operator's manual or other operational instructions provided by V.P.I.; (h) repairs or replacements resulting from parts or accessories which have adversely affected the operation, performance or durability of the equipment; or (i) damage or defects due to or arising out of repair of Ventrac equipment by person or persons other than an authorized Ventrac service dealer or the installation of parts other than genuine Ventrac parts or Ventrac recommended parts.

WARRANTY



LIMITED WARRANTY - VENTRAC COMMERCIAL EQUIPMENT

The sole liability of V.P.I. with respect to this warranty shall be the repair and replacement as set forth herein. V.P.I. shall have no liability for any other cost, loss, or damage. In particular V.P.I. shall have no liability or responsibility for: (i) expenses relating to gasoline, oil, lubricants; (ii) loss, cost or expense relating to transportation or delivery of turf equipment from the location of owner or location where used by owner to or from any Authorized Ventrac Dealer; (iii) travel time, overtime, after hours' time or other extraordinary repair charges or charge relating to repairs or replacements outside of normal business hours at the place of business of an Authorized Ventrac Dealer; (iv) rental of like or similar replacement equipment during the period of any warranty repair or replacement work; (v) any telephone or telegram charges; (vi) loss or damage to person or property other than that covered by the terms of this warranty; (vii) any claims for lost revenue, lost profit or additional cost or expense incurred as a result of a claim of breach of warranty; or (viii) attorney's fees.

The remedies of buyer set forth herein are exclusive and are in lieu of all other remedies. The liability of V.P.I., whether in contract, tort, under any warranty, or otherwise, shall not extend beyond its obligation as set forth herein. V.P.I. shall not be liable for cost of removal or installation nor shall V.P.I. be responsible for any direct, indirect, special or consequential damages of any nature. In no event shall V.P.I. be liable for any sum in excess of the price received for the goods for which liability is claimed.

There are no representations or warranties which have been authorized to the buyer of the Ventrac commercial equipment other than set forth in this warranty. Any and all statements or representations made by any seller of this equipment, including those set forth in any sales literature or made orally by any sales representative, are superseded by the terms of this warranty. Any affirmation of fact or promise made by V.P.I. or any of its representatives to the buyer which relates to the goods that are the subject to this warranty shall not be regarded as part of the basis of the bargain and shall not be deemed to create any express warranty that such goods shall conform to the affirmation or promise.

No employee, distributor, or representative is authorized to change the foregoing warranties in any way or grant any other warranty on behalf of V.P.I.

Some states do not allow limitations on how long an implied warranty lasts or allow the exclusion on limitation of incidental or consequential damages, so the above limitation or exclusion may not apply to you.

This warranty gives you specific legal rights, and you may also have other rights which vary from state to state.

This warranty applies to all Ventrac commercial equipment sold by Venture Products Inc.