



Operator's Manual

2100C

Serial Number 2100C-AP01001 - AP01230





500 Venture Drive
Orrville, OH 44667
www.ventrac.com

To the Owner Contact Information and Product Identification

If you need to contact an authorized Ventrac dealer for information on servicing your product, always provide the product model and serial numbers.

Please fill in the following information for future reference. See the picture(s) below to find the location of the identification numbers. Record them in the spaces provided.

Date of Purchase: _____

Dealer: _____

Dealer Address: _____

Dealer Phone Number: _____

Dealer Fax Number: _____

Model # (A): _____ Serial # (B): _____ <p style="text-align: center;">Affix Part/Serial Number label here.</p>



Engine Serial # (C) _____

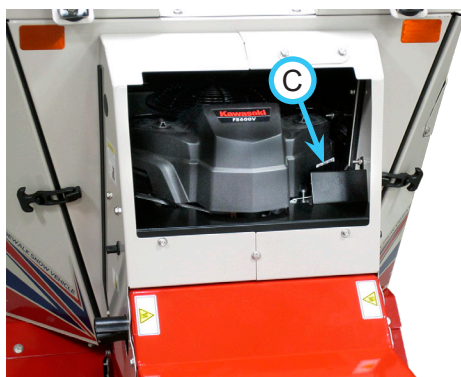

Venture Products Inc. reserves the right to make changes in design or specifications without obligation to make like changes on previously manufactured products.

TABLE OF CONTENTS

INTRODUCTION	PAGE 6
Product Description.....	6
Why Do I Need an Operator’s Manual?	6
Using Your Manual	7
Manual Glossary	7
SAFETY	PAGE 8
Safety Decals	8
General Safety Procedures.....	11
Training Required.....	11
Personal Protective Equipment Requirements	11
Operation Safety	11
Preventing Accidents.....	12
Keep Riders Off.....	12
Operating On Slopes.....	13
Roadway Safety	13
Truck Or Trailer Transport	13
Maintenance.....	14
Fuel Safety	14
Hydraulic Safety	15
Operator Safety Interlock System	16
2100 Safety Procedures.....	16
Testing the Safety Interlock System.....	17
OPERATIONAL CONTROLS	PAGE 18
Operational Control Locations.....	18
Cluster Gauge (A)	19
Headlight Switch (B).....	19
Ignition Switch (C).....	19
USB Receptacle (D).....	19
Drive Control Handles (E)	19
Hydraulic Control Lever (F).....	20
Parking Brake (G)	20
Choke Handle (H)	20
Throttle Lever (I).....	20
Latch Handle Lock (J)	20
Attachment Latch Handle (K).....	20
Auxiliary Hydraulic Quick Couplers (L).....	20
Circuit Breaker & Battery Disconnect (M)	20
Fuel Shut-off Valve (N).....	21
Rear Work Light Switch (AA)	21
Power Take Off (PTO) Switch (BB)	21
12 Volt Front Switch & 4-Pin Outlet (CC & EE).....	21
Brine Pump Switch (DD)	21
Weight Transfer Selector Handle (FF)	21
Attachment Belt Tension Spring (GG).....	21

TABLE OF CONTENTS

GENERAL OPERATION	PAGE 22
Daily Inspection.....	22
Starting the Engine.....	22
Forward and Reverse.....	22
Turning (Left, Right, & Turn in Place).....	23
Stopping the Power Unit.....	23
Shutting Off the Engine.....	23
Attaching.....	24
Detaching.....	25
Operating Attachments.....	25
Front Hitch.....	25
Front Auxiliary Couplers.....	25
Weight Transfer (Optional Accessory).....	26
Front 12 Volt 4-Pin Outlet (Optional Accessory).....	26
Towing Or Pushing the Power Unit.....	26
SERVICE	PAGE 27
Service and General Maintenance.....	27
Cleaning and Appearance Care.....	27
Service Access Points.....	28
Lubrication Locations.....	28
Checking Hydraulic Oil Level.....	29
Changing Hydraulic Oil & Filters.....	30
Servicing Hydraulic Oil Cooler.....	31
Checking Engine Oil Level.....	31
Changing Engine Oil and Filter.....	32
Air Filter Service and Replacement.....	33
Filling the Fuel Tank.....	33
Changing the Fuel Filter.....	34
Cleaning Engine Compartment & Engine.....	34
Servicing the Battery.....	34
Removing the Battery.....	35
Installing the Battery.....	35
Cleaning the Battery and Terminals.....	35
Charging the Battery.....	35
Jump Starting Procedure.....	36
Replacing Fuses.....	36
Replacing the Headlights and Work Lights.....	37
Belt Inspection.....	37
Pump Drive Belt Replacement.....	37
PTO Drive Belt Replacement.....	38
Wheel Removal & Installation.....	38
Tire Pressure.....	38
Parking Brake Adjustment.....	39
Parking Brake Switch Adjustment.....	39
Operator Presence Switch Adjustment.....	40

TABLE OF CONTENTS

SERVICE (Continued)

Drive Control Handle Adjustment.....	40
Neutral Arm Adjustment	41
Neutral Switch Adjustment	41
Storage.....	42
Maintenance Schedule.....	43
Maintenance Checklist.....	44
Ventrac Maintenance Log	45

TROUBLESHOOTING

PAGE 47

Wiring Diagram Reference Key.....	47
Wiring Harness Diagram	48
Wiring Diagram - Optional 30.0219 4-Pin Female Socket & 30.0218 4-Pin Male Plug.....	50
Engine	51
Electrical.....	52
Hydraulic	52
Power Unit.....	53

SPECIFICATIONS

PAGE 54

Engine	54
Electrical.....	54
Power Train	54
Controls & Instrument Panel	54
Other Features	54
Dimensions	54
Fluid Capacities & Specifications	55
Belt Chart	55

WARRANTY

PAGE 56

INTRODUCTION



Venture Products Inc. is pleased to provide you with your new Ventrac power unit! We hope that Ventrac equipment will provide you with a ONE Tractor Solution.

Listed below are just some of the items that can provide you *versatility* as you use your 2100 power unit. Please visit our website, or contact your authorized Ventrac dealer for a complete list of items available for your new power unit.

Attachments	Item Description	Part Number	Accessories	Item Description	Part Number
	Blade - 42"	39.65110		NA130 Drop Spreader	70.6001
Broom - 38"	39.65100	NB200 Brine System	70.6002		
		PTO Kit	70.6003		
		Weight Transfer Kit	70.6004		
		Rear Work Light Kit	70.6005		
		12 Volt Front Kit	70.6006		
		Storage Basket Kit	70.6010		

Product Description

The Ventrac 2100 SSV is a dedicated sidewalk snow vehicle with a 4x4 skid steer drive system. The 34 inch (86.4 cm) working width of the Ventrac 2100 allows access to narrow sidewalks and transitional areas, reducing the need for hand labor.

The Ventrac 2100 is designed with a full arsenal of snow removal attachments and de-icing options. A self aligning front hitch allows quick and easy mounting of snow removal attachments.

An optional PTO kit is available for powered attachments.

Why Do I Need an Operator's Manual?

This manual has been created to help you gain the important knowledge of what is needed to safely operate, maintain, and service your machine. It is divided into sections for convenient reference of the appropriate section.

You must read and understand the operator's manual for each piece of Ventrac equipment you own. Reading the operator's manual will help you become familiar with each specific piece of equipment. Understanding the operator's manual will help you, as well as others, avoid personal injury and/or damage to the equipment. Keep this manual with the machine at all times. The manual should remain with the machine even if it is sold. If this manual becomes damaged or unreadable, it should be replaced immediately. Contact your local Ventrac dealer for a replacement.

When using a Ventrac attachment, be sure to read and follow the safety and operating instructions of both the power unit and the attachment being used to ensure the safest operation possible.

The information in this manual provides the operator with the safest procedures to operate the machine while getting the maximum use out of the unit. Failure to follow the safety precautions listed in this manual may result in personal injury and/or damage to the equipment.

INTRODUCTION

Using Your Manual

Throughout this manual, you will encounter special messages and symbols that identify potential safety concerns to help you as well as others avoid personal injury or damage to the equipment.

SYMBOL DEFINITIONS



ATTENTION

This symbol identifies potential health and safety hazards. It marks safety precautions. Your safety and the safety of others is involved.

There are three signal words that describe the level of safety concern: Danger, Warning, and Caution. Safety should always be the #1 priority when working on or operating equipment. Accidents are more likely to occur when proper operating procedures are not followed or inexperienced operators are involved.

Note: Right-Hand and Left-Hand orientations may be referred to at different places throughout this manual. Right-Hand and Left-Hand is determined as if facing forward from the operator station.

SIGNAL WORD DEFINITIONS

⚠ DANGER

Indicates an imminently hazardous situation which, if not avoided, will result in death or serious injury. This signal word is limited to the most extreme cases.

⚠ WARNING

Indicates a potentially hazardous situation which, if not avoided, could result in death or serious injury.

⚠ CAUTION

Indicates a potentially hazardous situation which, if not avoided, may result in minor or moderate injury and/or property damage. It may also be used to alert against unsafe practices.

Manual Glossary

- Power Unit** A Ventrac tractor or other Ventrac engine powered device that may be operated by itself or with an attachment or accessory.
- Attachment** A piece of Ventrac equipment that requires a Power Unit for operation.
- Accessory** A device that attaches to a Power Unit or Attachment to extend its capabilities.
- Machine** Describes any "Attachment" or "Accessory" that is used in conjunction with a power unit.

SAFETY

Safety Decals

The following safety decals must be maintained on your Ventrac 2100 power unit.

Keep all safety decals legible. Remove all grease, dirt, and debris from safety decals and instructional labels. If any decals are faded, illegible, or missing, contact your dealer promptly for replacements.

When new components are installed, be sure that current safety decals are affixed to the replacement components.



SAFETY



1. WARNING: Read operator's manual.
2. Wear personal protective gear, such as eye protection, boots, ear protection, and warm clothing suitable for weather conditions.
3. Operators must receive training prior to operating the machine.
4. Do not operate with shields or guards removed.
5. WARNING: Read slope operation instructions. Slow down when operating on slopes.
6. WARNING: Keep a safe distance from the edge of drop-offs, curbs, ditches, etc. The machine could roll over if a wheel drops over the edge or if the edge caves in.
7. Do not carry passengers. Stop the machine if someone enters the work area.
8. Do not operate while under the influence of drugs or alcohol.
9. WARNING: Hydraulic fluid is under high pressure and can penetrate skin, causing injury. Keep hands, face, and body away from pinholes or nozzles that eject hydraulic fluid under high pressure.
10. When towing or pushing the power unit, the drive pumps must be disengaged by opening the bypass valve on both pumps or damage to the hydraulic system will result.



1. Cutting or crushing hazard - Stay away from moving parts.



1. Hot surface hazard - Hot surfaces can cause severe burns. Allow engine, exhaust components, and surrounding surfaces to cool before servicing.

SAFETY

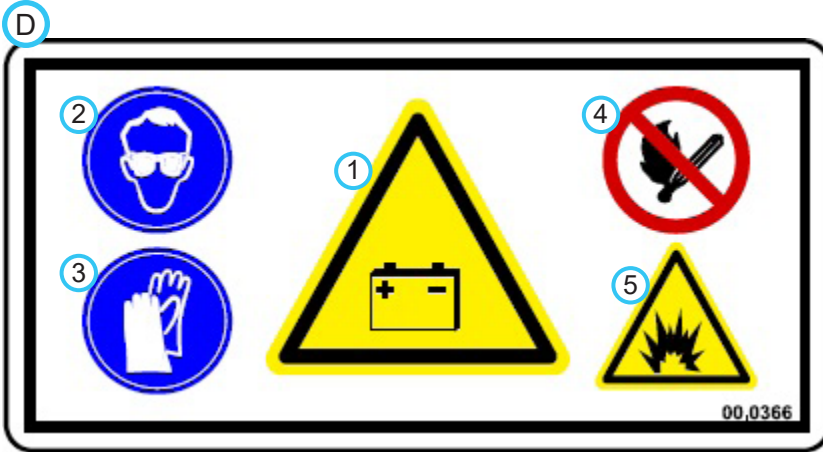

1. DANGER: Battery acid is caustic and can cause chemical burns. Keep bystanders a safe distance from the battery.
2. Wear eye protection, such as goggles or a face shield, when checking or servicing batteries.
3. Wear appropriate protective gear, such as rubber gloves and an apron, when checking or servicing batteries.
4. Do not expose batteries to arc, sparks, or open flames. Do not use smoking materials near batteries.
5. Explosion hazard - batteries produce flammable and explosive gases.



1. DANGER: Explosion / fire hazard.
2. Keep away from fire, sparks, and pilot lights when refueling or storing machine and fuel.
3. Smoking is prohibited.

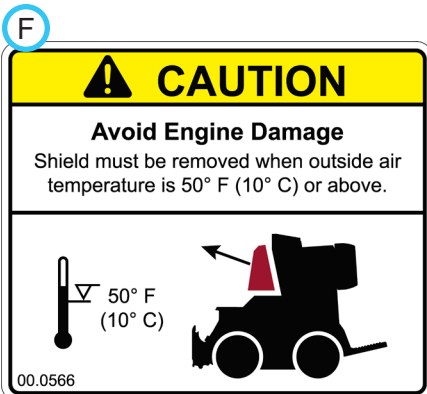

1. Remove the front, left, and right engine covers when the outside air temperature is 50° F (10° C) or above.

Decal	Description	Part Number	Quantity
A	Warning, Operator Safety	00.0437	1
B	Warning - Pinch Point	00.0218	2
C	Warning, Hot Surface	00.0374	6
D	Warning, Battery	00.0366	1
E	Warning, Gasoline Only	00.0457	1
F	Caution, Avoid Engine Damage	00.0566	2

SAFETY



General Safety Procedures for Ventrac SSV Power Units, Attachments, & Accessories



Training Required

- The owner of this machine is solely responsible for properly training the operators.
- The owner/operator is solely responsible for the operation of this machine and for the prevention of accidents or injuries occurring to him/herself, other people, or property.
- Do not allow operation or service by children or untrained personnel. Local regulations may restrict the age of the operator.
- Before operating this machine, read the operator's manual and understand its contents.
- If the operator of the machine cannot understand this manual, then it is the responsibility of this machine's owner to fully explain the material within this manual to the operator.
- Learn and understand the use of all the controls.
- Know how to stop the power unit and the attachments quickly in the event of an emergency.

Requirements for Personal Protective Equipment (PPE)

- The owner is responsible for ensuring that all the operators use the proper PPE while operating the machine. Whenever you use the machine, use the following PPE:
- Certified eye protection and hearing protection.
- Closed toe, slip resistant footwear.
- Long pants or trousers.
- A dust mask for dusty conditions.
- Appropriate cold weather clothing.
- Additional PPE may be required. Refer to the product safety procedures for any additional requirements.

Operation Safety

- Secure long hair and loose clothing. Do not wear jewelry.
- Inspect the machine before operation. Repair or replace any damaged, worn, or missing parts. Be sure the guards and shields are in proper working condition and are secured in place. Make any necessary adjustments before operating the machine.
- Some pictures in this manual may show shields or covers opened or removed in order to clearly illustrate the instructions. Under no circumstance should the machine be operated without these devices in place.
- Alterations or modifications to this machine can reduce safety and could cause damage to the machine. Do not alter the safety devices or operate with the shields or covers removed.
- Before each use, verify that all the controls function properly and inspect all the safety devices. Do not operate if the controls or safety devices are not in proper working condition.
- Check the parking brake function before operating. Repair or adjust the parking brake if necessary.
- Observe and follow all of the safety decals.
- All the controls are to be operated from the operator's station only.
- Ensure the attachment or accessory is locked or fastened securely to the power unit before operating.
- Ensure that all bystanders are clear of the power unit and the attachment before operating. Stop the machine if someone enters your work area.
- Always be alert to what is happening around you, but do not lose focus on the task you are performing. Always look in the direction the machine is moving.
- Look behind and down before backing up to be sure of a clear path.
- If you hit an object, stop and inspect the machine. Make any necessary repairs before operating the machine again.

SAFETY



General Safety Procedures for Ventrac Power Units, Attachments, & Accessories



- Stop operation immediately at any sign of equipment failure. An unusual noise can be a warning of equipment failure or a sign that maintenance is required. Make any necessary repairs before operating the machine again.
- Do not leave the machine unattended while it is running.
- Always park the machine on level ground.
- Always shut off the engine when connecting the attachment drive belt to the power unit.
- Never leave the operator's station without lowering the attachment to the ground, engaging the parking brake, shutting off the engine, and removing the ignition key. Make sure all moving parts have come to a complete stop before dismounting.
- Never leave the machine unattended without lowering the attachment to the ground, engaging the parking brake, shutting off the engine, and removing the ignition key.
- Only operate in well-lit conditions.
- Do not operate when there is a risk of lightning.
- Never direct the discharge of any attachment in the direction of people, buildings, animals, vehicles, or other objects of value.
- Never discharge material against a wall or obstruction. The material may ricochet back toward the operator.
- Use extra caution when approaching blind corners, shrubs, trees, or other objects that may obscure your vision.
- Do not run the engine in a building without adequate ventilation.
- Do not touch the engine or the muffler while the engine is running or immediately after stopping the engine. These areas may be hot enough to cause a burn.
- Do not change the engine governor settings or over-speed the engine. Operating the engine at excessive speeds may increase the hazard of personal injury.
- To reduce the hazard of fire, keep the battery compartment, engine, and muffler areas free of grass, leaves, excessive grease, and other flammable materials.
- Clear the working area of objects that might be hit or thrown from the machine.
- Keep people and pets out of the working area.
- Know the work area well before operation. Do not operate where traction or stability is questionable.
- Reduce speed when you are operating over rough ground.
- Equipment can cause serious injury and/or death when improperly used. Before operating, know and understand the operation and safety of the power unit and the attachment being used.
- Do not operate the machine if you are not in good physical and mental health, if you will be distracted by personal devices, or if you are under the influence of any substance which might impair your decisions, dexterity, or judgment.
- Children are attracted to machine activity. Be aware of children and do not allow them in the work area. Turn off the machine if a child enters the work area.

Keep Riders Off

- Only allow the operator on the power unit. Keep riders off.
- Never allow riders on any attachment or accessory.

SAFETY



General Safety Procedures for Ventrac Power Units, Attachments, & Accessories



Operating On Slopes

- Slopes can cause loss-of-control and tip-over accidents, which can result in severe injury or death. Be familiar with the emergency parking brake, along with the power unit controls and their functions.
- Do not operate on slopes greater than 10 degrees.
- Do not stop or start suddenly when operating on slopes.
- Variables such as wet surfaces and loose ground will reduce the degree of safety. Do not drive where the machine could lose traction or tip over.
- Keep alert for hidden hazards in the terrain.
- Stay away from drop-offs, ditches, and embankments.
- Sharp turns should be avoided when operating on slopes.
- Transport the machine with the attachment lowered or close to the ground to improve stability.
- While operating on slopes, drive in an up and down direction whenever possible. If turning is necessary while driving across slopes, reduce your speed and turn slowly in the downhill direction.

Roadway Safety

- Operate with safety lights when operating on or near roadways.
- Obey all state and local laws concerning operation on roadways.
- Slow down and be careful of traffic when operating near or crossing roadways. Stop before crossing roads or sidewalks. Use care when approaching areas or objects that may obscure vision.
- If there is any doubt of safety conditions, discontinue the machine operation until a time when the operation can be performed safely.

Truck Or Trailer Transport

- Use care when loading or unloading the machine into a truck or trailer.
- Use full width ramps for loading the machine into a truck or trailer.
- The parking brake is not sufficient to lock the machine during transport. Always secure the power unit and/or attachment to the transporting vehicle securely using straps, chains, cables, or ropes. Both the front and rear straps should be directed down and outward from the machine.
- Shut off the fuel supply to the power unit during transport on a truck or trailer.
- Turn the battery disconnect switch to the Off position to shut off electrical power.

Maintenance

- Keep the safety decals legible. Remove all grease, dirt, and debris from the safety decals and instructional labels.
- If any decals are faded, illegible, or missing, contact your dealer promptly for replacements.
- When new components are installed, be sure that the current safety decals are affixed to the replacement components.
- If any component requires replacement, use only original Ventrac replacement parts.
- Always turn the battery disconnect to the Off position or disconnect the battery before performing any repairs. Disconnect the negative terminal first and the positive terminal last. Reconnect the positive terminal first and the negative terminal last.
- Keep all bolts, nuts, screws, and other fasteners properly tightened.

SAFETY



General Safety Procedures for Ventrac Power Units, Attachments, & Accessories



- Always lower the attachment to the ground, engage the parking brake, shut off the engine, and remove the ignition key. Make sure all moving parts have come to a complete stop before cleaning, inspecting, adjusting, or repairing.
- If the power unit, attachment, or accessory requires repairs or adjustments not instructed in the operator's manual, the power unit, attachment, or accessory must be taken to an authorized Ventrac dealer for service.
- Never perform maintenance on the power unit and/or attachment if someone is in the operator's station.
- Always use protective glasses when handling the battery.
- Check the fuel lines for tightness and wear on a regular basis. Tighten or repair them as needed.
- To reduce the hazard of fire, keep the battery compartment, engine, and muffler areas free of grass, leaves, and excess grease.
- Do not touch the engine, the muffler, or other exhaust components while the engine is running or immediately after stopping the engine. These areas may be hot enough to cause a burn.
- Allow the engine to cool before storing and do not store near an open flame.
- Do not change the engine governor settings or over-speed the engine. Operating engine at excessive speeds may increase the hazard of personal injury.
- Springs may contain stored energy. Use caution when disengaging or removing springs and/or spring loaded components.
- An obstruction or blockage in a drive system or moving/rotating parts may cause a buildup of stored energy. When the obstruction or blockage is removed, the drive system or moving/rotating parts may move suddenly. Do not attempt to remove an obstruction or blockage with your hands. Keep your hands, feet, and clothing away from all power-driven parts.

Fuel Safety

- To avoid personal injury or property damage, use extreme care in handling gasoline. Gasoline is extremely flammable and the vapors are explosive.
- Do not refuel the machine while smoking or at a location near flames or sparks.
- Always refuel the machine outdoors.
- Do not store the machine or fuel container indoors where the fumes or fuel can reach an open flame, spark, or pilot light.
- Only store fuel in an approved container. Keep out of the reach of children.
- Never fill containers inside a vehicle or on a truck or trailer bed with a plastic liner. Always place the containers on the ground away from your vehicle before filling.
- Remove the machine from the truck or trailer and refuel it on the ground. If this is not possible, refuel the machine using a portable container, rather than from a fuel dispenser nozzle.
- Never remove the fuel cap or add fuel with the engine running. Allow the engine to cool before refueling.
- Never remove the fuel cap while on a slope. Only remove the fuel cap when parked on a level surface.
- Replace the fuel tank cap and the container cap securely.
- Do not overfill the fuel tank. Only fill to the bottom of the fuel neck, do not fill the fuel neck full. Overfilling of the fuel tank could result in engine flooding, fuel leakage from the tank, and/or damage to the emissions control system.
- If fuel is spilled, do not attempt to start the engine. Move the power unit away from the fuel spill and avoid creating any source of ignition until the fuel vapors have dissipated.
- If the fuel tank must be drained, it should be drained outdoors into an approved container.
- Check the fuel lines for tightness and wear on a regular basis. Tighten or repair them as needed.
- The fuel system is equipped with a shut-off valve. Shut off the fuel when transporting the machine to and from the job, when parking the machine indoors, or when servicing the fuel system.

SAFETY



General Safety Procedures for Ventrac Power Units, Attachments, & Accessories



Hydraulic Safety

- Make sure the hydraulic connections are tight and all hydraulic hoses and tubes are in good condition. Repair any leaks and replace any damaged or deteriorated hoses or tubes before starting the machine.
- Hydraulic leaks can occur under high pressure. Hydraulic leaks require special care and attention.
- Use a piece of cardboard and a magnifying glass to locate suspected hydraulic leaks.
- Keep your body and hands away from pinhole leaks or nozzles that eject high pressure hydraulic fluid. Hydraulic fluid escaping under high pressure can penetrate the skin causing serious injury, leading to severe complications and/or secondary infections if left untreated. If hydraulic fluid is injected into the skin, seek immediate medical attention no matter how minor the injury appears.
- The hydraulic system may contain stored energy. Before performing maintenance or repairs on the hydraulic system, remove any attachments, engage the parking brake, disengage the weight transfer system (if equipped), shut off the engine, and remove the ignition key. To relieve pressure on the auxiliary hydraulic system, shut off the power unit engine and move the hydraulic control lever left and right before disconnecting the auxiliary hydraulic quick couplers.

SAFETY



2100 Safety Procedures



- Do not operate the Ventrac 2100 without an attachment mounted on the front.
- Do not make rapid changes in speed or direction. Reduce vehicle speed on slopes and when making sharp turns to prevent loss of control.
- Do not operate on frozen bodies of water unless you have verified the thickness and strength of the ice and that the travel path is safe.
- Do not operate on slopes greater than 10 degrees.
- Power unit hydraulic system may contain stored energy. Before performing maintenance or repairs on the auxiliary hydraulic circuit, remove attachments, engage the parking brake, disengage the weight transfer system (if equipped), shut off engine, and remove the key from the ignition.
- Weight transfer spring may contain stored energy. Always disengage the weight transfer system (if equipped) before performing maintenance or repairs on the weight transfer system, the front hitch, or the lift (front hitch) hydraulics.
- If power unit is being operated when outside air temperatures are above 50° F (10° C), the front, left, and right engine covers must be removed to prevent damage from engine overheating.



Warning

Operating, servicing, and maintaining off-road equipment can expose you to chemicals including engine exhaust, carbon monoxide, phthalates, and lead, which are known to the State of California to cause cancer and birth defects or other reproductive harm. To minimize exposure, avoid breathing exhaust, do not idle the engine except as necessary, service equipment in a well-ventilated area and wear gloves or wash your hands frequently when servicing your equipment.

For more information go to www.P65Warnings.ca.gov



Attention

It is a violation of California Public Resource Code Section 4442 to use or operate this engine on forest-covered, brush-covered, or grass-covered lane unless the exhaust system is equipped with a spark arrester maintained in effective working order. If your power unit is not equipped with a spark arrester, contact your authorized Ventrac dealer for purchase of a spark arrester.

Operator Safety Interlock System

The 2100 power unit is equipped with a safety interlock system. This system:

- Prevents the engine from starting unless the parking brake is engaged.
- Prevents the PTO from starting if the operator is not on the platform.
- Shuts off the PTO if the operator leaves the platform.
- Shuts off the engine if the operator leaves the platform without engaging the parking brake.
- Shuts off the engine if the drive control handles are moved from the neutral position while the parking brake is engaged.

SAFETY



2100 Safety Procedures



Testing the Safety Interlock System

⚠️ WARNING

Never operate the power unit if the safety interlock system is malfunctioning. Do not disengage or bypass any switch. Failure to heed warning could result in injury to yourself and others, or damage to property.

⚠️ CAUTION

The daily inspection should be performed prior to initial startup for the day.

Perform the following safety interlock tests daily. Before testing, park the power unit on a level surface and place wheel chocks in front and back of wheels. After testing is complete, engage the parking brake, and remove the wheel chocks.

Tests 1-4 test the 'Engine Start' function. For each test, turn the key to the RUN position (do not start the engine). As listed for each test, engage or disengage the parking brake, place the drive control handles in neutral or out of neutral, and stand on the operator platform or step off the platform. The engine starter should or should not engage as described for each test.

Tests 5-9 test the 'Engine Run' function. For each test, start the power unit so that the engine is running. As listed for each test, engage or disengage the parking brake, place the drive control handles in neutral or out of neutral, and stand on the operator platform or step off the platform. The engine should continue running or stop running as described for each test.

Tests 10-13 test the 'PTO' function. For each test, turn the key to the RUN position (do not start the engine). As listed for each test, place the PTO switch in the ON or OFF position and stand on the operator platform or step off the platform. The electric PTO clutch will make an audible noise when it engages or disengages.

Engine Start	Test Number	Parking Brake Engaged	Drive Control Handles in Neutral	Operator Present on Platform	Engine Starts
	1	No	Yes	Yes	No
	2	Yes	No	Yes	No
	3	Yes	Yes	No	Yes
	4	Yes	Yes	Yes	Yes
Engine Run	Test Number	Parking Brake Engaged	Drive Control Handles in Neutral	Operator Present on Platform	Engine Runs
	5	Yes	Yes	Yes	Yes
	6	Yes	Yes	No	Yes
	7	Yes	No	No	No
	8	Yes	No	Yes	No
9	No	Yes	No	No	No
PTO	Test Number	PTO Switch		Operator Present on Platform	PTO Clutch
	10	Off		Yes	Off
	11	Pull to 'On' Position		No	Off
	12	Pull to 'On' Position		Yes	On
	13	Switch On, with Parking Brake Engaged		Yes	On (Engine will not start)
	14	On		Step Off Operator Platform	PTO Disengages (1/2 second delay)

If the power unit fails any one of the safety interlock tests, refer to the troubleshooting section to diagnose electrical problems.

OPERATIONAL CONTROLS

Operational Control Locations

Use the following images to help identify the locations of operational controls. The letter next to each control can be referenced to the list that follows these images.

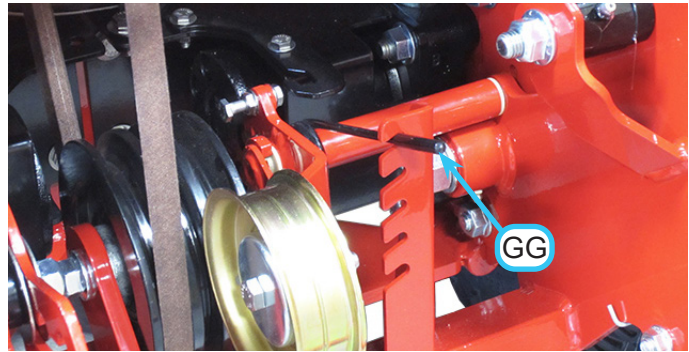
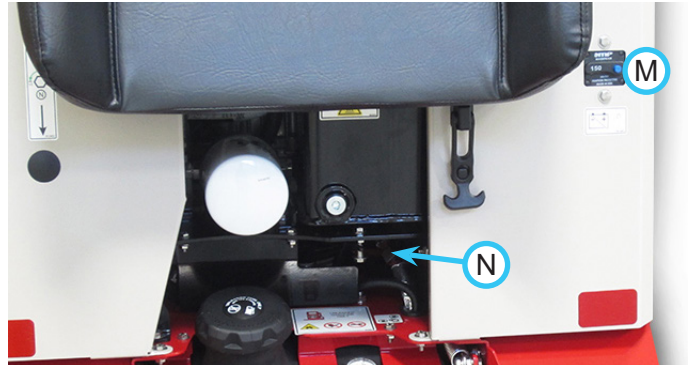
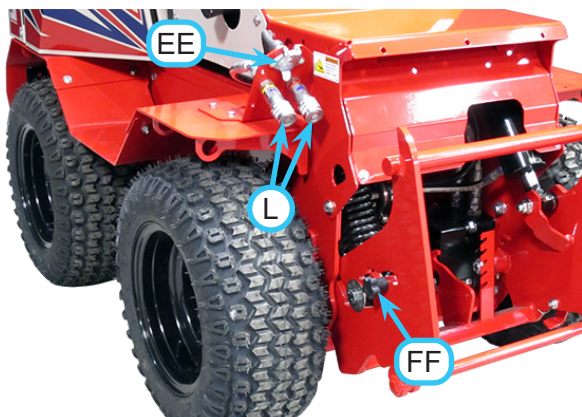
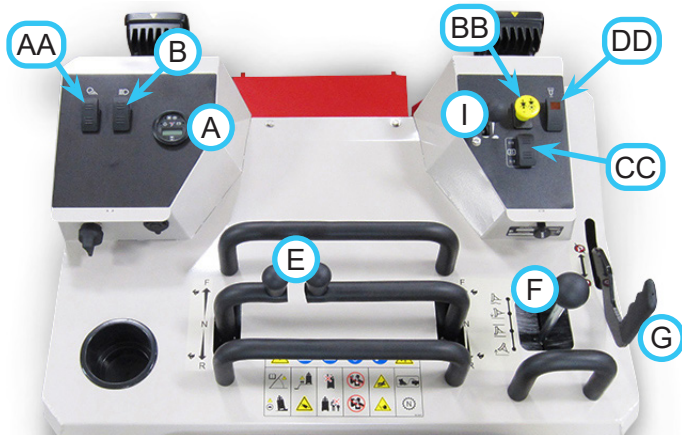

Standard Operational Controls

- A. Cluster Gauge
- B. Headlight Switch
- C. Ignition Switch
- D. USB Receptacle
- E. Drive Control Handles
- F. Hydraulic Control Lever
- G. Parking Brake
- H. Choke Handle
- I. Throttle Lever
- J. Latch Handle Lock
- K. Attachment Latch Handle
- L. Auxiliary Hydraulic Quick Couplers
- M. Circuit Breaker & Battery Disconnect
- N. Fuel Shut-off Valve

Optional Operational Controls

- AA. Rear Work Light Switch
- BB. Power Take Off (PTO) Switch
- CC. Front 12V Switch (Momentary On/Off/On)
- DD. Brine Pump Switch
- EE. Front 12V 4-Pin Outlet
- FF. Weight Transfer Selector Handle
- GG. Attachment Belt Tension Spring

OPERATIONAL CONTROLS

Cluster Gauge (A)



1. Hour Meter
2. Low Engine Oil Pressure Warning Light
3. PTO Indicator Light
4. Parking Brake Indicator Light
5. Low Voltage Warning Light

The **hour meter** displays the accumulated time the engine has been running.

The **low engine oil pressure warning light** activates when the engine oil pressure is below safe levels. The light comes on when the ignition key is switched to the on position and stays illuminated until the engine is started and safe oil pressure develops. If this light comes on during operation, immediately shut off the engine. Do not restart the engine until the problem has been located and corrected.

The **PTO indicator light** activates when power is supplied to the PTO clutch.

The **parking brake indicator light** activates when the parking brake is engaged.

The **low voltage warning light** activates when the voltage drops to unacceptable levels. If this light comes on, shut off any unnecessary lights and accessories to reduce current draw. If voltage continues to drop, park the power unit, shut off the engine, and remove the key from the ignition. Refer to the troubleshooting section for possible problems.

Headlight Switch (B)

Pressing the front (1) of the headlight switch turns the headlights on. Pressing the back (0) of the switch turns the lights off.



Ignition Switch (C)

1. Off or Stop Position - all 12 volt power going through the key switch is off.
2. On or Run Position - engine run position, 12 volt power is sent to accessories.
3. Start Position - when the key is turned to the start position, the starter will engage.

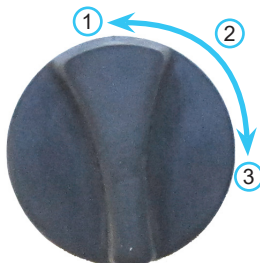

USB Receptacle (D)

The USB receptacle has two USB charging ports with a sealed cover.

Drive Control Handles (E)

The drive control handles are used to control both the speed and direction of the power unit. The left drive handle controls the left wheels and the right drive handle controls the right wheels.

⚠ WARNING

Slow down when making sharp turns to prevent overturn accidents or loss of control.

Do not make rapid changes in speed or direction. Rapid movement of the drive control handles may result in loss of control that could result in serious injury.

To move **forward**, push both drive control handles forward an equal distance from the neutral position.

To move in **reverse**, pull both drive control handles back an equal distance from the neutral position.

The amount of forward or backward movement of the drive control handles controls the ground speed of the power unit.

To make a **turn**, slow the power unit to an appropriate speed to make the turn, then move the drive control handle toward neutral in the desired direction of turn (e.g. move the left drive control handle toward neutral to make a left turn).

To **stop**, move both drive control handles to the neutral position.

NOTE: refer to General Operation section of this manual for detailed instructions and illustrations for driving and turning the power unit.

OPERATIONAL CONTROLS

Hydraulic Control Lever (F)

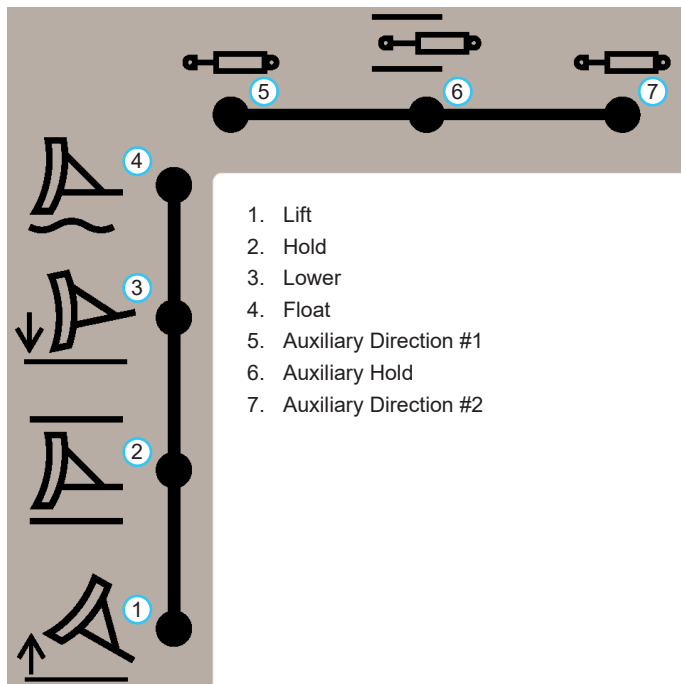

The hydraulic control lever controls the lift of the power unit's front hitch and the auxiliary hydraulic circuit.

Hold is the default position of the hydraulic control lever. It holds the position of the front hitch and the auxiliary circuit.

Pulling the lever back raises the power unit's front hitch. Pushing the lever forward lowers the power unit's front hitch. Float position is attained by pushing the lever forward until the float detent locks the lever in place.

Moving the lever to the left or right controls the functions of attachments that require the auxiliary hydraulic circuit (e.g. angles snow plow right or left).

Parking Brake (G)



When parking the power unit, always engage the parking brake to prevent accidental movement of the machine.

To engage the parking brake, pull the brake handle back toward the operator.

To disengage the parking brake, push the brake handle forward.

If the parking brake is set, attempting to move the power unit will shut off the engine. If the operator leaves the platform without engaging the parking brake, the engine will shut off.

1. Parking Brake Disengaged
2. Parking Brake Engaged (Set)

Choke Handle (H)

Pull the choke handle out to aid in starting a cold engine. Push the choke handle in for operation.

Throttle Lever (I)

Moving the throttle lever forward toward the fast position (1) increases the engine Revolutions Per Minute (RPM). Moving the throttle lever backward toward the slow position (2) decreases the engine RPM.



Latch Handle Lock (J)

The latch handle lock prevents the accidental release of the attachment latch handle. To release the attachment latch handle, rotate the latch handle lock down away from the latch handle.

Attachment Latch Handle (K)

The attachment latch handle secures the attachment to the power unit's hitch.

Rotate the latch handle backward to disengage the latch tab when attaching or detaching Ventrac attachments.

Rotate the latch handle forward to lock the attachment frame to the front hitch. Ensure the latch tab is engaged in the attachment lower hitch plate and the latch handle lock is in place.

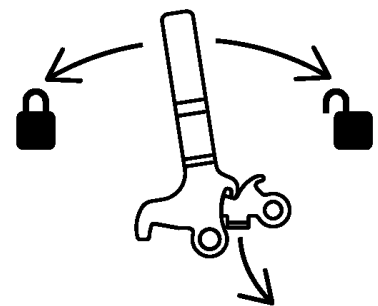

Auxiliary Hydraulic Quick Couplers (L)

The two couplers are a part of the auxiliary hydraulic circuit and are used with an attachment that requires hydraulics (e.g. to angle a snow plow or rotate the discharge on a snow blower).

Circuit Breaker & Battery Disconnect (M)

The circuit breaker/battery disconnect switch controls power to the entire electrical system.

Pushing the button (0) on the switch disables the electrical system, allowing electrical components to be serviced.

When the button on the switch is pushed to disengage electrical power, a reset lever (1) drops down from the switch body. Lift up on the reset lever to restore electrical power.



0. Push to disengage power
1. Lift to restore power

OPERATIONAL CONTROLS

Fuel Shut-off Valve (N)

The fuel shut-off valve controls the flow of fuel to the power unit engine. Turning the valve to position 1 (indicator aligned with fuel hose) will allow fuel to flow to the engine.

Turning the valve to position 0 (indicator perpendicular to fuel hose) shuts off the fuel flow to the engine.

Turn off the fuel shut-off valve when transporting the power unit on a truck or trailer and when parking the power unit indoors.

To prevent fuel leakage when changing fuel filters or servicing the fuel system, turn off the fuel shut-off valve, start the engine, and allow to run until the engine stops.

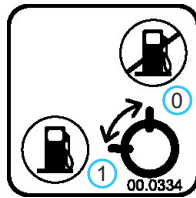

- 0. Fuel Off
- 1. Fuel On

Rear Work Light Switch (AA)

Pressing the front (1) of the rear work light switch turns the rear work lights on. Pressing the back (0) of the switch turns the rear work lights off.

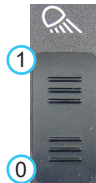

Power Take Off (PTO) Switch (BB)

Pulling up on the PTO switch engages the electric clutch to provide power to the front attachment.

Pushing down on the PTO switch disengages the electric clutch and applies the clutch brake to stop the attachment. NOTE: the engine will shut off if the operator leaves the platform with the PTO engaged. In order to restart the engine, the PTO switch must be turned off.



- 0. PTO Off
- 1. PTO On

12 Volt Front Switch & 4-Pin Outlet (CC & EE)

The 4-pin socket provides electrical power to attachments that are equipped with electrical controls. (e.g. broom rotation actuator)

The switch controls the electrical power to the front 4-pin socket. Pressing the top (1) or bottom (2) portion of the momentary on/off/momentary on switch turns on electrical power to the 4-pin socket. Releasing the switch turns off electrical power.

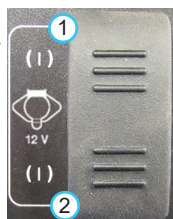

- 1. Momentary On
- 2. Momentary On

Brine Pump Switch (DD)

Pressing the front (1) of the brine pump switch turns on electrical power to the brine pump. Pressing the back (0) of the switch turns the pump off.

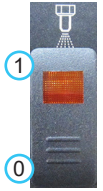

Weight Transfer Selector Handle (FF)

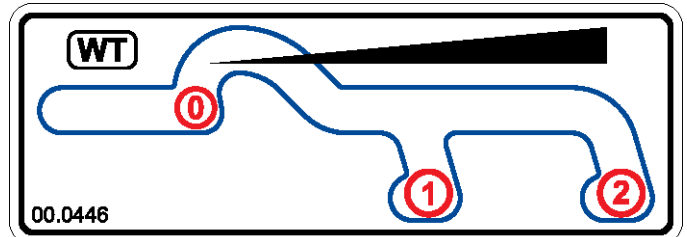

The weight transfer system transfers weight from the attachment to the front wheels of the power unit. Transferring weight from the attachment to the power unit increases traction, aids in lifting the attachment, and lessens the attachment resistance when in contact with the ground and operating with hitch in float.

The operator can select different transfer rates by selecting one of the three positions from no weight transfer (0) to maximum weight transfer (2).

Set weight transfer to (0) when attaching or detaching any attachment.

The weight transfer can only be adjusted with the front hitch fully raised.

Attachment Belt Tension Spring (GG)

The belt tension spring places tension on the attachment drive belt. The spring bracket has several hook positions to allow adjustments in belt tension. When removing an attachment, the spring is released, rotated up and back, and held in place with a catch plate while not in use.

GENERAL OPERATION

Daily Inspection

⚠ WARNING

Always set the parking brake, shut off power unit engine, remove the ignition key, and ensure all moving parts have come to a complete stop before inspecting components, or attempting any repair or adjustment.

1. Park the power unit on a level surface, with the engine shut off and all fluids cold.
2. Perform a visual inspection of the power unit. Look for loose or missing hardware, damaged components, or signs of wear.
3. Inspect the battery, electrical connections, and lights.
4. Ensure parking brake tension is properly adjusted.
5. Inspect hydraulic hoses, hydraulic fittings, and fuel lines to ensure tight, leak free connections.
6. Inspect belts for damage or excessive wear. Service as required.
7. Check the power unit's engine oil level, hydraulic oil level, and fuel level. Add fluid or service as required.
8. Ensure air cleaner and engine compartment are clean.
9. Check tires for proper inflation.
10. Test the power unit's operator safety interlock system*.

Starting the Engine

⚠ CAUTION

Do not use ether or starting fluids. Use of starting fluids in the air intake system may be potentially explosive or cause a runaway engine condition. Use of starting fluids could result in engine damage and/or personal injury.

⚠ CAUTION

Allow time for hydraulic oil to circulate before operating the power unit. Severe damage could result to the hydraulic system if adequate warm up isn't allowed. Warm up time is increased in colder weather.

The 2100 is equipped with an interlock system for operator safety. The safety interlock system requires the parking brake to be engaged in order for the engine to start.

1. Turn the fuel shut-off valve to the On position.
2. Set the battery disconnect switch to the On position.
3. Pull the choke handle out to the choke on or start position. Choke may not be required if the engine is already warm.
4. Move the throttle lever to half throttle position.

⚠ CAUTION

Do not run the electric starter continuously for more than 5 seconds. If the engine does not start right away, wait 15 seconds and try again.

5. Turn the ignition key clockwise to the start position and hold to engage the starter. Release the key when the engine starts. NOTE: if engine fails to start, refer to the troubleshooting section.
6. After starting the engine, gradually push the choke handle back in to the run position.
7. The engine and hydraulic oil must be warmed to operating temperature before applying load. Allow the engine to run at half throttle for 3 to 5 minutes.

Forward and Reverse

Verify the intended path is safe and free from obstacles and disengage the parking brake.

Power unit movement is controlled by moving the left and right drive control levers in the desired direction of travel. Push the drive control levers forward to move the power unit in the forward direction.

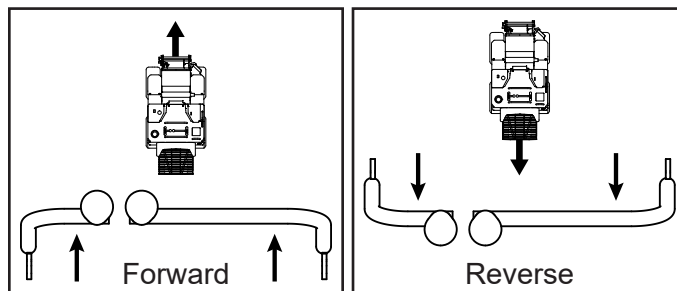

Pull the drive control levers backward to make the power unit move in the reverse direction. Changing the amount the drive control levers are moved instantly changes the ground speed of the power unit. Moving the drive control levers one half stroke will result in approximately one half of the maximum ground speed. Moving the levers to the end of the stroke will result in maximum ground speed.

GENERAL OPERATION

Turning (Left, Right, & Turn in Place)

Turning is accomplished by varying the amount of stroke between the right and left drive control handles. If the drive control handles are not moved the same distance from neutral, the power unit will turn in the direction of the lever closest to the neutral position.

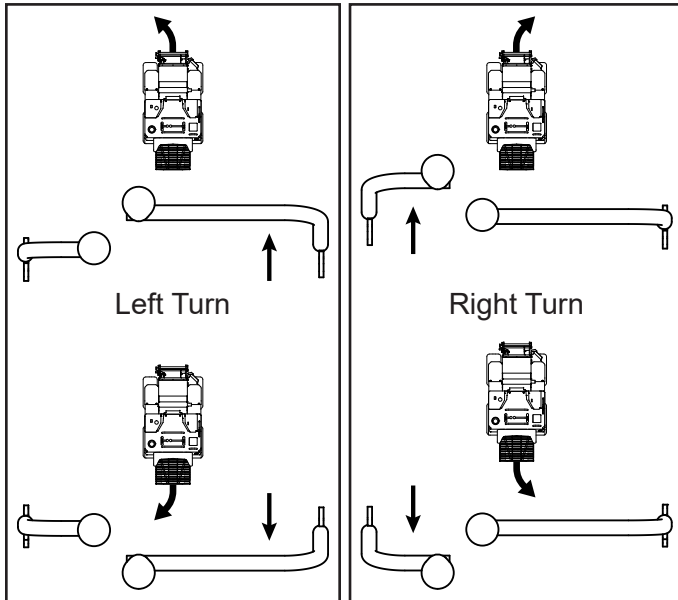

The greater the stroke variance between the left and right drive control levers, the sharper the power unit will turn.

To turn in place, move one lever forward from neutral and the other lever backward from neutral.

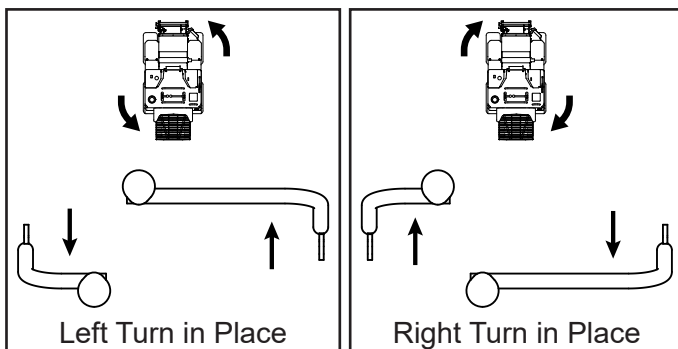

Stopping the Power Unit

To slow or stop the power unit, move the drive control levers in the opposite direction that you are traveling. Return the drive control levers to the neutral position to make a complete stop.

If in the case of an emergency, the power unit cannot be stopped with the drive control levers, pull back on the parking brake handle to engage the parking brake.

CAUTION

If the parking brake is engaged while the power unit is moving, the engine will shut off and the power unit will come to an abrupt stop.

Shutting Off the Engine

1. Park the power unit on a level surface and engage the parking brake.
2. Move the throttle lever to the slow idle position.
3. Allow the engine to idle for one minute.



Attention

Engine damage can occur from run-on or after-burning if the engine is stopped suddenly from high speed loaded operation. Allow the engine to idle for one minute before shutting off the engine.

4. Turn the ignition key to the Off position and remove the key from the ignition switch.
5. When parking the power unit at the end of the day, push the button on the battery disconnect switch to disengage power and turn the fuel shut-off valve to the Off position.

GENERAL OPERATION

Attaching

1. Align the power unit squarely with the attachment and drive forward slowly until the power unit hitch is close to the attachment frame.
2. Lower the power unit hitch until the hitch tabs (A) are below the top latch plate(s) on the attachment hitch frame.

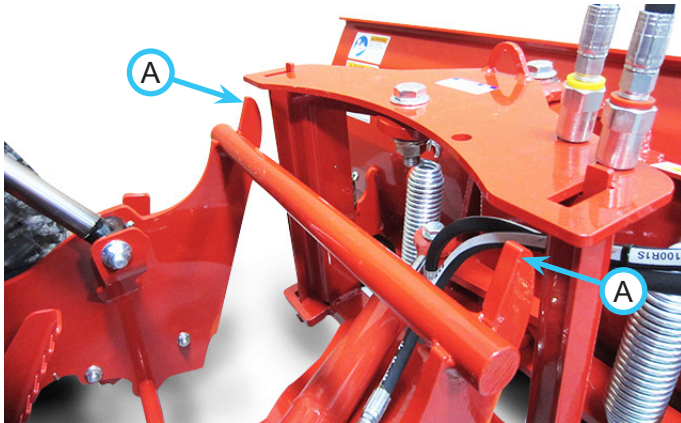

3. Drive forward slowly until the power unit hitch tabs are aligned with the hitch point slots in the attachment hitch frame.
4. Raise the power unit hitch to engage the tabs in the hitch point slots. Continue to raise the hitch until the attachment is lifted just off the ground.
5. Engage the parking brake and shut off the power unit engine.
6. Rotate the attachment latch handle forward to the latched position. Make sure the latch tabs (B) are engaged in the lower latch plate, and the latch handle lock (C) is engaged to prevent accidental disengagement of the latch handle.

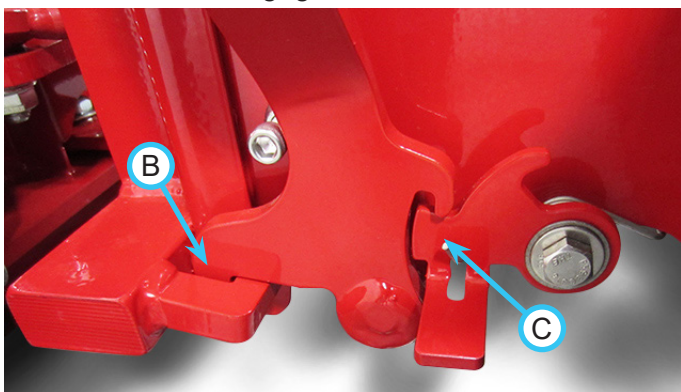
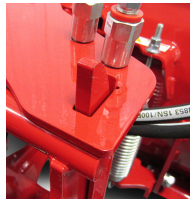

7. Place the attachment belt* onto the PTO drive pulley on the power unit. Ensure the belt is properly seated in each pulley.

8. Engage the drive belt tension spring (D) on the power unit to apply tension to the attachment belt.

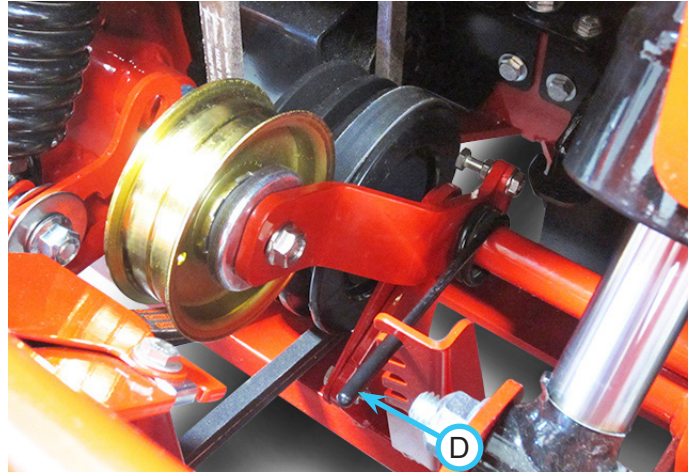

9. Wipe hose ends* clean and connect to the power unit's hydraulic quick couplers. Connect the hoses and quick couplers so the colored indicator washers are paired together.
10. Connect the electric actuator plug* to the matching socket on the power unit.

*Applies only if the attachment is equipped.

GENERAL OPERATION

Detaching

1. Park the power unit on a level surface and set the parking brake.
2. Lower the attachment to the ground.
3. Shut off power unit engine.
4. Disconnect the electric actuator plug* from the socket on the power unit.
5. Move the hydraulic control lever left and right to release pressure from the auxiliary hydraulic circuit and disconnect the hydraulic quick couplers* from the power unit. Store hose ends in the attachment frame holes.
6. Disengage the drive belt tension spring on the power unit and hook into the spring catch plate (A).

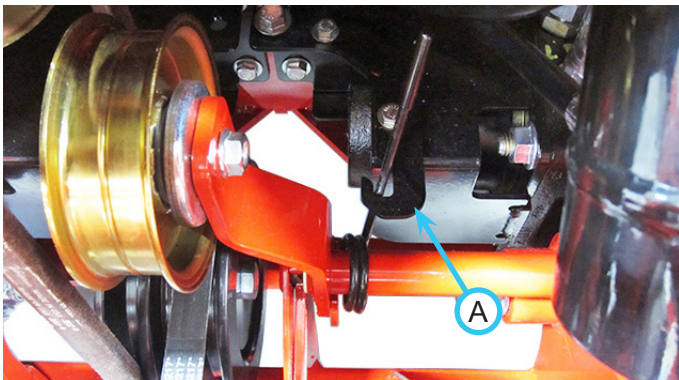

7. Remove the attachment belt from the PTO drive pulley of the power unit.
8. Disengage the latch handle lock and rotate the attachment latch handle back to unlatch from the lower latch plate on the attachment.
9. Restart the power unit and lower the power unit hitch to clear the top latch plate on the attachment hitch frame, while slowly backing away from the attachment.

*Applies only if the attachment is equipped.

Operating Attachments

Refer to the operator's manual for each attachment for the proper use and operation of the particular attachment. The operator must read and understand the operator's manual prior to using an attachment.

Front Hitch

The front hitch is used to secure attachments to the power unit and to raise and lower the attachment. The front hitch is controlled by the hydraulic control lever. Pull the lever back to raise the attachment and push the lever forward to lower the attachment. Push the lever forward until the float detent engages and holds the lever in place to operate in float.

Front Auxiliary Couplers

CAUTION

Dirt and other debris in the hydraulic system can cause damage to the system. Wipe the mating parts of the couplers clean before coupling.

If the attachment requires auxiliary hydraulics, couple the attachment hoses with the front auxiliary couplers. Insert the end of the attachment hose into the power unit coupler and push until it locks in place.



To disconnect the couplers, pull back on the collar on the power unit coupler to release the attachment hose.

The couplers that the hoses are attached to will affect the direction the hydraulic control lever is moved to control the action of the attachment. Connect the hoses and quick couplers so the colored indicator washers are paired together (red to red, yellow to yellow).

The auxiliary couplers are controlled by moving the hydraulic control lever to the left or right.

NOTE: pressure buildup in the attachment hoses and the power unit couplers may occur, causing difficult installation of hoses. If hoses do not easily connect, try one or both of the following steps.

1. To release the pressure from power unit couplers, turn off the engine and move the hydraulic control lever left and right to release pressure in the power unit's hydraulic circuit.
2. To release pressure in the attachment hose, loosen one of the hose ends and retighten after pressure is released.

WARNING



Hydraulic fluid is under high pressure and can penetrate skin, causing injury. Keep hands, face, and body away from pinholes or nozzles that eject hydraulic fluid under high pressure.

GENERAL OPERATION

Weight Transfer (Optional Accessory)

The weight transfer system transfers weight from the attachment to the front wheels of the power unit. Transferring weight from the attachment to the power unit increases traction, aids in lifting the attachment, and lessens the attachment resistance when in contact with the ground when operating with hitch in float.

The operator can select different transfer rates by selecting one of the three positions from no weight transfer (0) to maximum weight transfer (2). Set weight transfer to (0) when attaching or detaching any attachment.

To set the weight transfer, raise the front hitch to its maximum height and move the weight transfer selector handle to the desired position.

NOTE: if the adjustment knob will not easily move positions, the weight transfer spring may need to be adjusted. Refer to the service section for adjustment instructions.

Selecting the proper amount of weight transfer depends on the attachment, conditions, and operator preference. A lightweight attachment will not operate in float with full weight transfer on. A heavy attachment may be difficult to lift and control without weight transfer engaged.

Front 12 Volt 4-Pin Outlet (Optional Accessory)

Certain attachments or accessories require a 12 volt auxiliary outlet. Plug the attachment's 12 volt power cord into the 4-pin outlet. The actions of the front 12 volt outlet are controlled by a momentary on/off/on switch on the right dash panel.

Towing Or Pushing the Power Unit



Attention

Avoid damage to your power unit! Before towing, read and understand the information below. Severe damage will occur to unit if proper towing procedure is not followed.



CAUTION

Failure to open the bypass valves on both pumps when towing or pushing the power unit will result in damage to the hydraulic drive system.

1. Place the drive control handles in the neutral position and engage the parking brake.
2. Shut off engine and remove the key from the ignition switch.
3. Open the bypass valve on both pumps by turning counterclockwise 1/4 to 1/2 turn. This allows hydraulic oil to flow past the pump so the wheels can turn.



CAUTION

When the pump bypass valves are open and the parking brake is released, the power unit can free-wheel. Do not attempt to tow or push the power unit on steep slopes. Use extreme caution and move the power unit slowly when towing or pushing.

4. Release the parking brake and push or tow the power unit slowly to the desired location. Do not exceed 3 mph (5 km/h). NOTE: steering will not function when towing or pushing.
5. Engage the parking brake.
6. Close the bypass valve on both pumps. Torque to 110 - 130 in-lbs (12.5 - 14.5 Nm).

GENERAL OPERATION

Removal of Engine Covers

If operating the power unit in temperatures above 50° F (10° C), the engine covers must be removed to prevent overheating of the engine.

1. Park the power unit on a level surface and engage the parking brake.
2. Shut off the power unit's engine and remove the key from the ignition switch.

WARNING

Failure to allow the engine, muffler, and covers to cool down prior to proceeding with engine cover removal may result in severe burns from contact with hot surfaces.

3. Allow the engine, muffler, and engine covers to cool before proceeding.
4. Unfasten the rubber handles that secure the front cover and remove the cover (A) from the power unit.

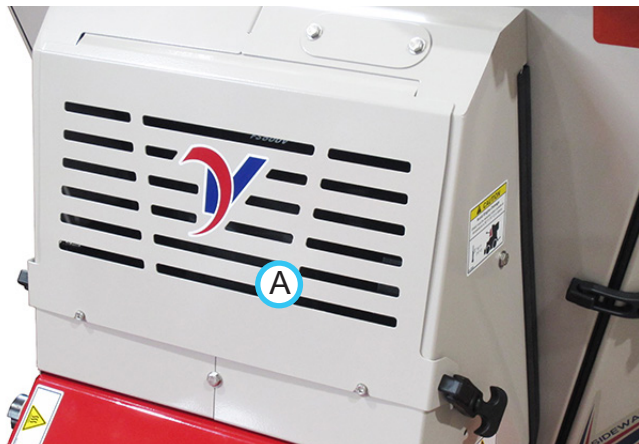

5. If the power unit is equipped with a brine system or drop spreader, disconnect any hoses and wire harnesses that route through the grommets in the top and right side of the engine covers and pull the hoses/harnesses out of the engine covers.
6. Remove the three bolts (B) that fasten the top of the left and right covers to each other and to the tower frame cover.

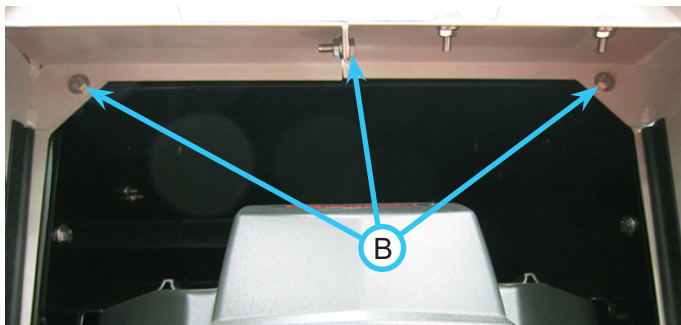

7. Remove the three bolts (C) that fasten the left side cover to the airflow divider plate.

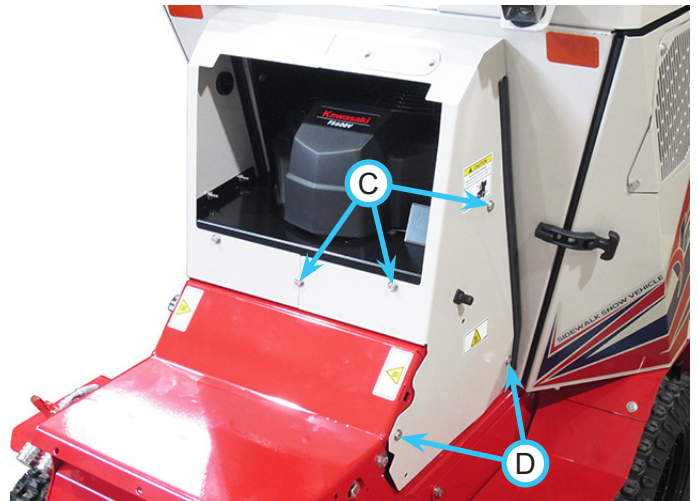

8. Remove the two bolts (D) that fasten the left side cover to the rear cover bracket and the accessory mount/shield frame and remove the left side cover from the power unit.
9. Remove the two bolts (E) that fasten the right side cover to the rear cover bracket and the accessory mount/shield frame and remove the right side cover and airflow divider plate from the power unit.

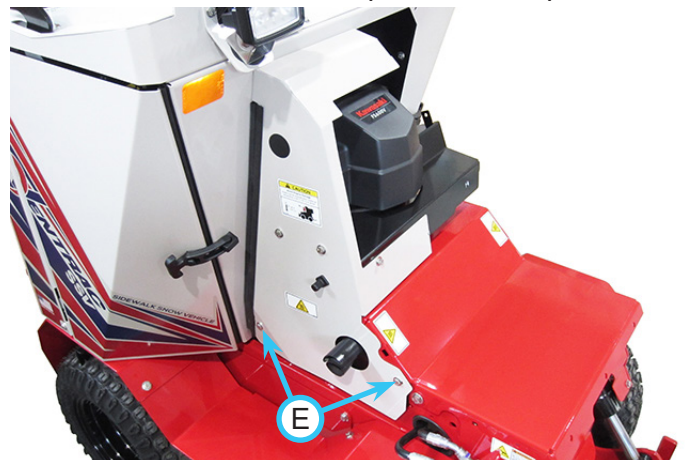

10. If the power unit is equipped with a brine system or drop spreader, reconnect the hoses and/or wire harnesses.
11. Place the engine covers and hardware in a safe storage location to prevent loss or damage.

GENERAL OPERATION

Installation of Engine Covers

1. Park the power unit on a level surface and engage the parking brake.
2. Shut off the power unit's engine and remove the key from the ignition switch.

WARNING

Failure to allow the engine, muffler, and covers to cool down prior to proceeding with engine cover removal may result in severe burns from contact with hot surfaces.

3. Allow the engine, muffler, and engine covers to cool before proceeding.
4. If the power unit is equipped with a brine system or drop spreader, disconnect any hoses and wire harnesses that route through the front tower opening.
5. Install the right side cover and airflow divider plate onto the lower right engine cover mount and the accessory mount/shield frame using two 1/4 x 3/4" bolts (A) and washers. Do not tighten.

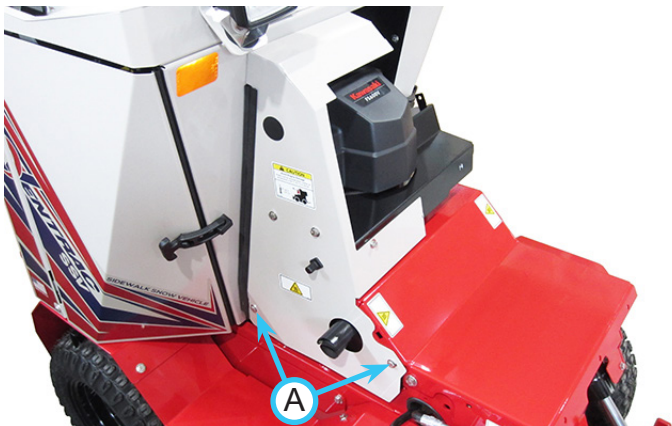

6. Install the left side cover onto the lower left engine cover mount and the accessory mount/shield frame using two 1/4 x 3/4" bolts (B) and washers. Do not tighten.

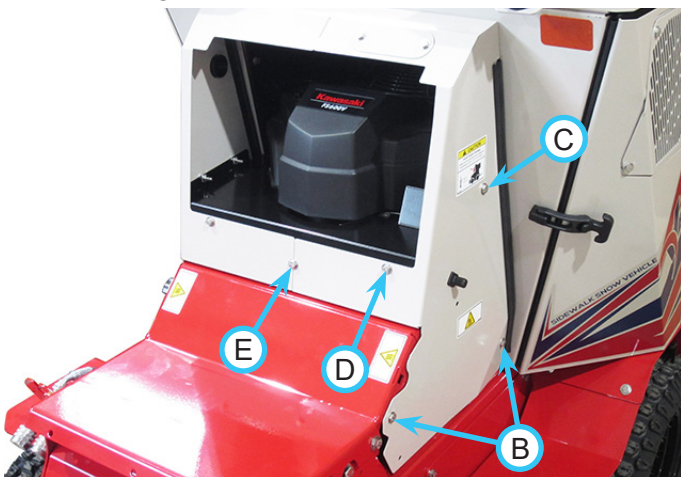

7. Secure the airflow divider plate to the left side cover using a 1/4 x 3/4" bolt (C), washer, and flange nut and a 1/4 x 3/4" socket head cap screw (D) and washer. Do not tighten.
8. Install a 1/4 x 3/4" bolt (E) and washer in the hole where the left and right covers meet.
9. Loosely fasten the left and right covers to the front tower cover in the upper corners using two 1/4 x 3/4" bolts (F) and washers. Do not tighten.

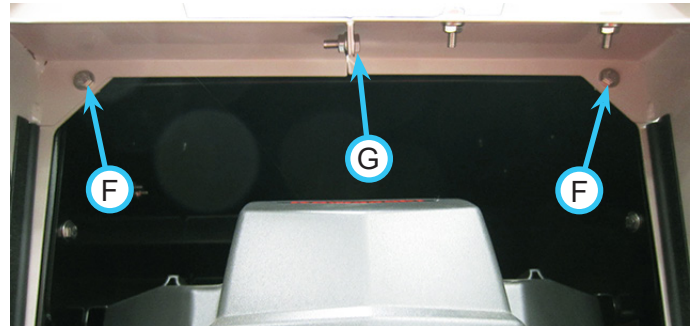

10. Fasten the upper flanges of the left and right covers together using a 1/4 x 3/4" bolt (G), washer, and flange nut. Align the front edges of the left and right covers and torque the bolt to 67 in-lbs (8 Nm).
11. Align the edges of the lower flanges on the left and right covers and torque the bolt (E) where the covers meet to 67 in-lbs (8 Nm).
12. Tighten the six mounting bolts (A, B, & F) for the left and right covers. Torque to 67 in-lbs (8 Nm).
13. Tighten the bolts (C & D) that fasten the airflow divider plate to the left side cover. Torque to 67 in-lbs (8 Nm).
14. If the power unit is equipped with a brine system or drop spreader, route the hoses and/or wire harnesses through the grommets on the top and right side of the engine covers and reconnect.
15. Install the front engine cover (H) and secure with the rubber handles.



SERVICE

⚠️ WARNING

Always set the parking brake, shut off power unit engine, remove the ignition key, and ensure all moving parts have come to a complete stop before inspecting components or attempting any repair or adjustment.



Attention

Ventrac recommends that service be performed by a qualified technician. If you are unsure how to perform the service procedure(s), contact your Ventrac dealer.



Attention

If any component requires replacement, use only original Ventrac replacement parts.

Service and General Maintenance

Proper and timely service of this power unit is critical to keep the power unit in a safe and reliable operating condition. Follow the maintenance schedule at the end of the service section. For convenience, a frequent service guide decal and a quick reference chart decal have been placed on the inside of the right door.



Cleaning and Appearance Care

For best results, and to maintain the finish of the power unit, clean or wash the power unit to remove dirt, salt deposits, and ice or snow accumulations.



Attention

To maintain the finish of the power unit, thoroughly wash the equipment after each use to remove any corrosive agents (e.g., salt). Failure to clean the equipment may result in corrosion of (including but not limited to) steel, aluminum, and electrical components. Equipment that will experience repeated exposure to corrosive agents should be pretreated with a corrosion preventative.

⚠️ CAUTION

If the engine has been running, it must be allowed to cool in order to prevent damage to the block and exhaust manifold.

Do not direct high pressure water at the engine, muffler, hydraulic oil cooler, or any electrical components.

Allow the power unit and all components to cool before washing. Refer to the specific service section for proper cleaning techniques for the engine and engine compartment. Use mild soap and water to clean the power unit. Harsh chemical cleaners could cause damage to the finish or components.

After cleaning, use touch up paint to repair chips and scratches in the finish.

SERVICE

Service Access Points

Throughout the service section, different access points are referred to. The following list and images identify shields and covers that may need to be removed or opened during service.



- 1. Operator cushion
- 2. Left door
- 3. Left engine cover
- 4. Accessory mount/shield frame



- 5. Right door
- 6. Right engine cover
- 7. Front access panel (engine)
- 8. PTO drive cover
- 9. PTO belt cover (under muffler)

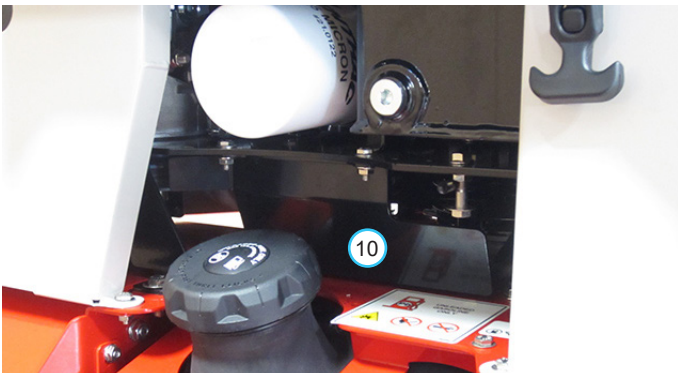

- 10. Pump belt drive cover

Lubrication Locations

Lubrication is required at the following locations. Refer to the maintenance schedule for service intervals and amount of grease. Refer to Specifications section for grease type.

Lift Cylinder Lower End & Hitch Pivots

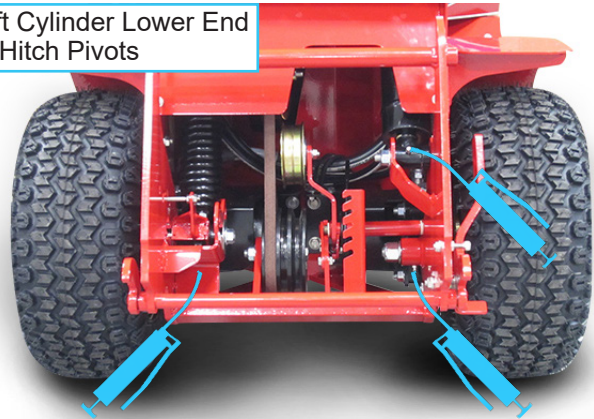

Lift Cylinder Upper End (Left engine cover removed)

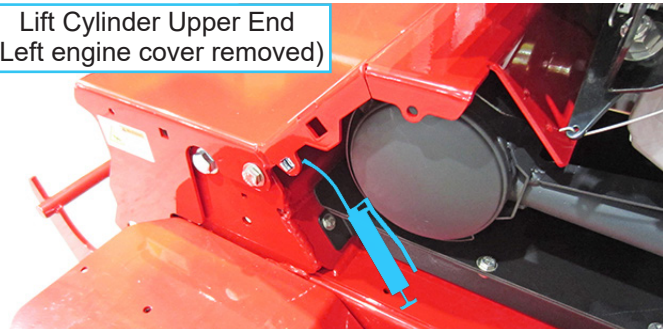

Operator Platform Pivot

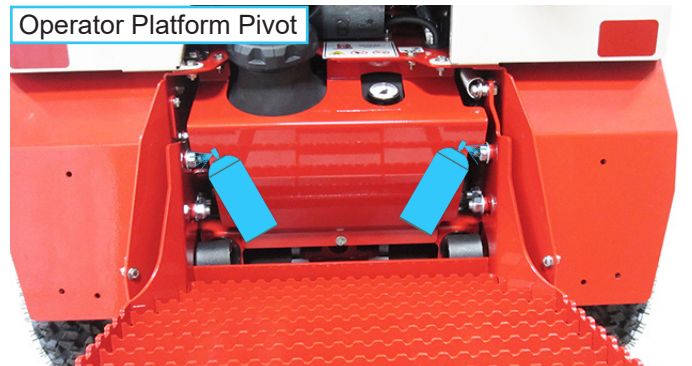

Valve Control Links Spherical Rod Ends

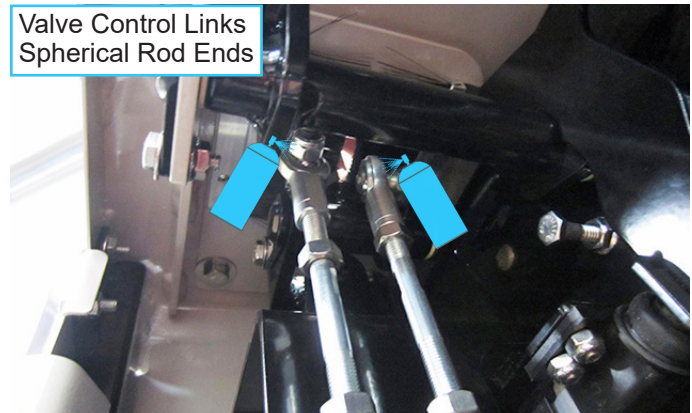

SERVICE

Pump Control Links Spherical Rod Ends

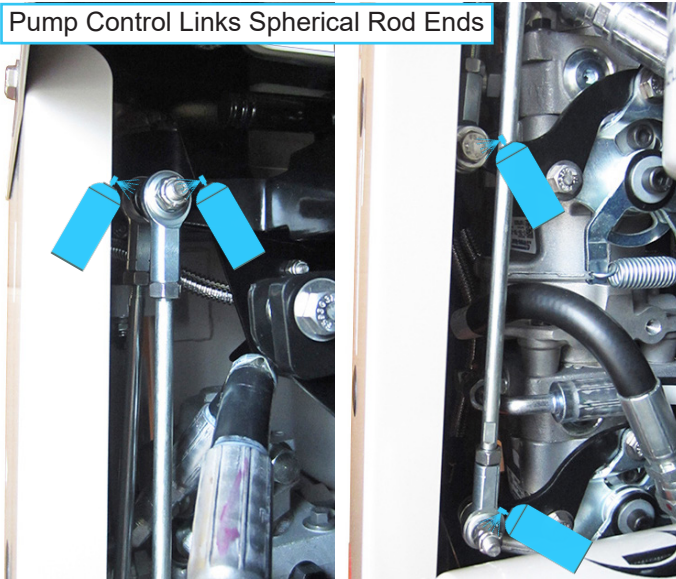

Checking Hydraulic Oil Level

Check the hydraulic oil level when the hydraulic system is cold, prior to operating the power unit. If the hydraulic system is warm, allow one hour for the hydraulic system to cool before checking the oil level. Checking the oil level when the hydraulic system is warm will produce an inaccurate oil level reading.



Attention

After connecting a new attachment or kit that runs off the power unit's hydraulic system, run the attachment or kit through a complete cycle, then stop and check the hydraulic oil level.

1. Park the power unit on a level surface.
2. Fully raise the front hitch.
3. Engage the parking brake and shut off the engine.
4. Remove the key from the ignition switch and allow time for the hydraulic system to cool.
5. Remove the operator cushion from the rear panels of the power unit.
6. Remove the dipstick (A) from the hydraulic oil tank and wipe with a clean cloth.
7. Set the dipstick back in place without threading in.
8. Remove the dipstick and check the oil level. The level should be between the two notches on the dipstick.
9. If the hydraulic oil level is low, add Ventrac HydroTorq XL synthetic hydraulic oil until the proper level is reached.
10. Reinstall the dipstick into the hydraulic oil tank.
11. Place the operator cushion back on the power unit.

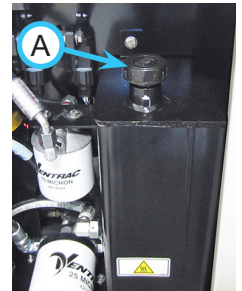

SERVICE

Changing Hydraulic Oil & Filters

1. Drive the front wheels of the power unit onto 2" x 4" blocks to raise the front of the power unit 1-1/2 - 2 inches (4 -5 cm).
2. Fully raise the front hitch.
3. Engage the parking brake and shut off the engine.
4. Remove the key from the ignition switch and allow time for the hydraulic system to cool.
5. Remove the operator cushion from the rear panels of the power unit.
6. Place a drain pan (minimum 12 quart / 11.5 liter) beneath the operator platform.
7. Using a funnel with a hose attached and routed down through the operator platform to the drain pan, hold the funnel underneath the drain port (A) on the hydraulic oil tank.



8. Remove the drain plug from the hydraulic oil tank and allow the hydraulic oil to drain from the system. Loosen the dipstick on the hydraulic oil tank to allow venting.
9. Clean the drain plug, reinstall into the hydraulic oil tank, and torque to 31 ft-lbs (42 Nm).
10. Clean the hydraulic filters and filter heads.
11. Place a rag under the large filter and over the fuel tank area to soak up spilled oil.

12. Use a strap type filter wrench to unscrew both the large and small hydraulic filters (B) from the filter heads. After removal, drain the filters into the drain pan.

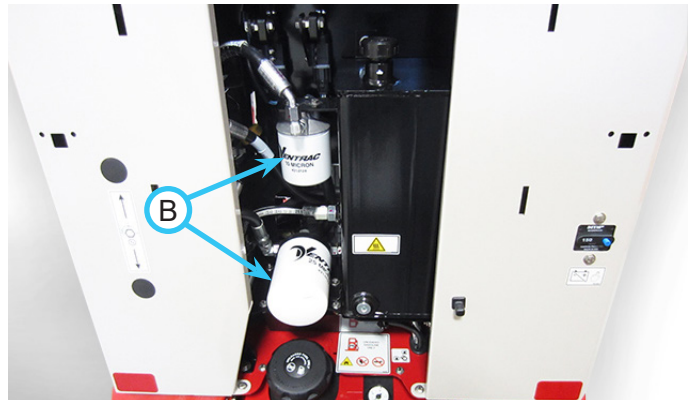

13. Ensure filter mounting surfaces are clean.
14. Apply a thin film of clean oil to the gasket of the new large filter and screw the filter onto the filter head until the gasket makes contact with the mounting surface. Tighten the filter an additional 3/4 of a turn (may require using a strap type filter wrench).
15. Apply a thin film of clean oil to the gasket of the new small filter and screw the filter on to the filter head until the gasket makes contact with the mounting surface. Tighten the filter an additional 1 turn (may require using a strap type filter wrench).
16. Clean up any spilled oil and dispose of oil and filters in accordance with local laws.

CAUTION

Oil is hazardous to the environment. Drain oil into an approved container and dispose of used oil in accordance with local laws.

17. Add Ventrac HydroTorq XL synthetic hydraulic oil to the hydraulic oil tank until the proper level is reached.
18. Start the power unit and let it run for several minutes at low idle engine speed. Drive the power unit back and forth in forward and reverse for several cycles.
19. Shut off the power unit engine and engage the parking brake. Allow the power unit to sit for a minimum of five minutes.
20. Check the hydraulic oil level and add Ventrac HydroTorq XL synthetic hydraulic oil, if necessary.
21. Place the operator cushion back on the power unit.

SERVICE

Servicing Hydraulic Oil Cooler

1. Brush any dirt and debris from the oil cooler screen (A) in the left door.
2. Open the left door and use low pressure air to blow back through the oil cooler to remove accumulated dust or debris from the oil cooler fins.



7. Check the oil level. The level should be between the Full (B) and Add (C) marks on the dipstick.



8. If the oil level is low, add small amounts of engine oil to bring the oil level no higher than the Full (B) mark on the dipstick.
9. If the oil level is above the Full (B) mark, drain some engine oil to achieve the proper level.
10. Reinstall the dipstick and close the left door.

Checking Engine Oil Level



Attention

Avoid engine damage!

Failure to check the oil level regularly could lead to serious damage to your engine if the engine is run with an incorrect oil level.

- Check the engine oil level with the power unit sitting on a level surface and with the engine shut off and the oil cold.
- Keep oil level between the **FULL** and **ADD** marks.
- Do not add oil with the engine running.

1. Park the power unit on a level surface.
2. Engage the parking brake and shut off the engine.
3. Remove the key from the ignition switch and allow the engine and oil to cool.
4. Open the left door.
5. Remove the oil dipstick (A) from the engine and wipe with a clean cloth.



6. Insert the dipstick back into the engine without threading it in and remove again.

SERVICE

Changing Engine Oil and Filter

⚠ CAUTION

Contact with engine oil can irritate your skin. Wear protective gloves when working with engine oil. If you come in contact with engine oil, wash it off immediately.

⚠ CAUTION

Oil is hazardous to the environment. Drain engine oil into an approved container and dispose of used engine oil in accordance with local laws.

1. Start the power unit engine and allow it to run until the engine reaches operating temperature.
1. Park the power unit on a level surface.
2. Engage the parking brake and shut off the engine.
3. Remove the key from the ignition switch.
4. Open the left door.
5. Place a drain pan beside the left rear tire.
6. Remove the engine oil drain hose (A) from the storage retainer (B) in front of the hydraulic pump stack and lay the hose down on the fender with the end above the drain pan.

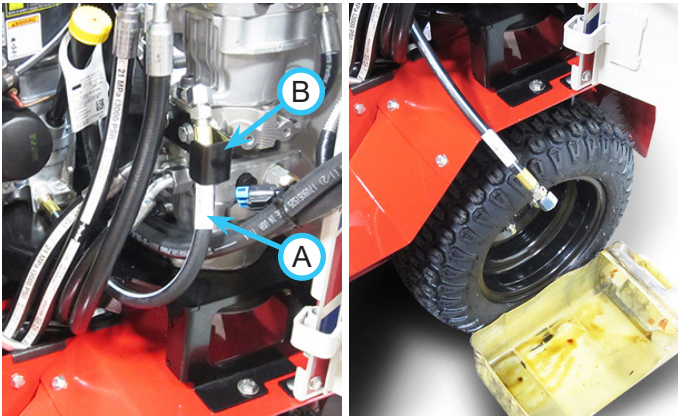

⚠ WARNING

Hot engine oil can cause severe burns. Allow the engine temperature to drop from hot to warm before draining the oil.

7. Remove the drain cap from the oil drain hose and drain into the pan while the oil is warm.

8. Remove the oil filter (C) located on the side of the engine. Turn the filter counterclockwise to remove.



9. Wipe the filter mounting surface with a clean cloth.
10. Apply a thin film of clean oil to the gasket of the new oil filter.
11. Install the new filter turning it clockwise until the gasket makes contact with the mounting surface. Tighten the filter 1/2 to 3/4 of a turn more by hand.
12. Clean the end of the oil drain hose and make sure the O-ring is in place on the end of the hose fitting. Reinstall the drain cap and torque to 35 ft-lbs (47 Nm).
13. Remove the oil dipstick from the engine.
14. Add oil to the engine. Refer to Engine Owner's Manual for proper oil specifications and capacity.

Attention: Engine Oil Recommendation

For optimal engine life and performance, use Ventrac Full Synthetic Engine Oil.
Part # 15.0037-1



15. Install the oil dipstick and wipe up any oil spills.
16. Start the engine and run at slow idle speed for approximately 2 to 3 minutes.
17. Shut off the engine and remove the ignition key.
18. Check for oil leaks around the oil filter.
19. Check the engine oil level after allowing the engine to cool for approximately 2 minutes. Add oil if necessary.
20. Close the left door.

SERVICE

Air Filter Service and Replacement.



Attention

Avoid engine damage!

Improper service to the engine air filter can result in severe engine damage.

- Never run the engine without a proper air filter installed.
- Never wash or use pressurized air to clean the paper filter element.
- Do not oil the foam or paper filter elements.

The air filter is composed of an inner paper element and an outer foam element. The foam element can be cleaned and reused.

1. Park the power unit on a level surface.
2. Engage the parking brake and shut off the engine.
3. Remove the key from the ignition switch and allow the engine to cool.
4. Turn the plastic nuts (A) on the air cleaner cover (B) counterclockwise 1/4 turn and remove the cover from the engine.

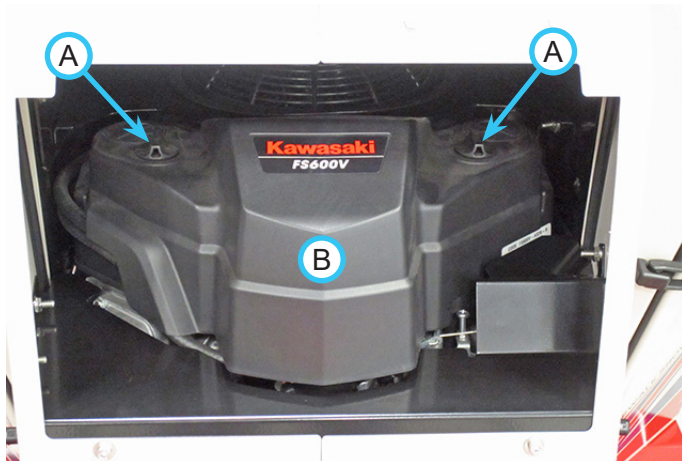

5. Remove the foam element (C) from the filter.
6. Wash the foam element in detergent and water. Rinse and dry thoroughly before reinstalling.
7. If the paper filter element is scheduled for replacement, loosen the thumb screw (D) on the band clamp and remove the filter element from the intake hose.

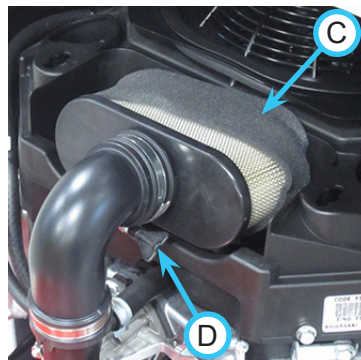

8. Install the new paper filter element and tighten the band clamp.
9. Place the foam element onto the paper filter element and reinstall the air filter cover.

Filling the Fuel Tank

DANGER

Fuel is flammable and/or explosive. Follow all safety instructions in the Fuel Safety section of this manual and in the engine owner's manual.

WARNING

Long term exposure to fuel vapors can cause serious injury or illness. Avoid prolonged breathing of fuel vapors.

If fuel is spilled on skin or clothing, change clothing and wash affected skin immediately.

CAUTION

Avoid engine damage!

Only use fuel that meets the specifications required for your engine. Refer to the engine owner's manual for the proper grade and specifications of fuel for your engine.

1. Park the power unit on a level surface.
2. Engage the parking brake and shut off the engine.
3. Remove the key from the ignition switch and allow the engine to cool.
4. Wipe the fuel cap (A) clean to prevent any dirt from falling into the fuel tank and remove the fuel cap.
5. Add fuel to the tank until the fuel level reaches the bottom of the fuel neck. Do not overfill by filling the fuel neck, as this may cause engine flooding. Keep the fuel nozzle in contact with the rim of the fuel neck until fueling is completed.
6. Replace the fuel cap and tighten.
7. Wipe up any fuel spills and allow fuel vapors to dissipate before starting the engine.



SERVICE

Changing the Fuel Filter

1. Park the power unit on a level surface and engage the parking brake.
2. Turn the fuel shut-off valve to the Off position and allow the engine to run until it stops.
3. Remove the key from the ignition switch.

⚠ WARNING

Failure to allow the engine to cool down sufficiently could result in severe burns from contact with hot engine components.

4. Allow the engine to cool before proceeding.
5. Open the right door.
6. Locate the fuel filter (A) at the right rear corner of the engine. Clip the plastic zip tie holding the fuel line and filter to the engine bracket and pull the fuel filter away from the engine to access the clamps.
7. Place shop towels underneath the fuel filter to catch any fuel drips from the filter or fuel line.
8. Loosen the hose clamps and remove the fuel filter.
9. Install the new fuel filter with the flow arrow pointing toward the engine and fasten securely with the hose clamps.
10. Use a plastic zip tie to fasten the fuel line to the engine bracket to prevent interference with the parking brake linkage.
11. Turn the fuel shut-off valve to the On position.

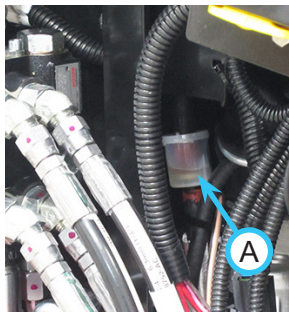

⚠ CAUTION

The initial engine start after changing the fuel filter may require a longer cranking time for the engine to start. Do not run the electric starter continuously for more than 5 seconds. If the engine does not start right away, wait 15 seconds and try again.

12. Start the power unit engine and inspect the filter hose connections for leaks.
13. Close the right door.

Cleaning Engine Compartment & Engine

Inspect or clean the engine compartment and engine daily to reduce the risk of engine overheating.

1. Park the power unit on a level surface.
2. Engage the parking brake and shut off the engine.

3. Remove the key from the ignition switch and allow the engine to cool.
4. Open the left and right doors.
5. Remove accumulated dust or debris from the engine compartment and engine. Clean any debris from the rotating screen.
6. Close the left and right doors.

Servicing the Battery

⚠ DANGER

The battery produces a flammable and explosive gas. The battery may explode.

- Wear eye protection and gloves.
- Do not smoke near battery.
- Keep arcs, sparks, and open flames away from batteries.
- Do not allow direct metal contact across the battery posts.
- Remove the negative battery cable first when disconnecting the battery.
- Install the negative battery cable last when connecting the battery.

⚠ WARNING

Avoid Personal Injury!

Battery electrolyte contains sulfuric acid. It is poisonous and can cause severe chemical burns.

- Wear eye and skin protection.
- If battery electrolyte is spilled on skin or clothing, change clothing and wash affected skin immediately. Seek medical attention if necessary.
- If battery electrolyte is splashed in eyes, flush immediately with water for 15-30 minutes and seek immediate medical attention.
- If battery electrolyte is swallowed, get medical attention immediately. Drink large quantities of water, followed by Milk of Magnesia, beaten egg, or vegetable oil. DO NOT induce vomiting.

⚠ CAUTION

Batteries contain poisonous and hazardous substances. Dispose of used batteries in accordance with local laws.

SERVICE

Removing the Battery

1. Park the power unit on a level surface.
2. Engage the parking brake and shut off the engine.
3. Remove the key from the ignition switch.
4. Open the right door.
5. Disconnect the negative (-) battery cable (A).

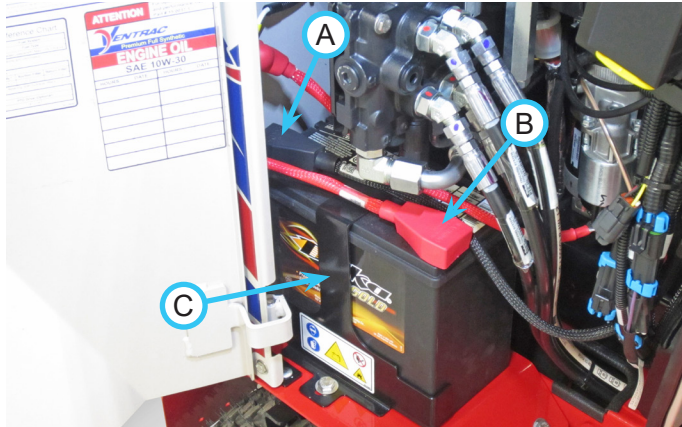

6. Disconnect the positive (+) battery cable (B).
7. Remove the battery mount bracket (C).
8. Remove the battery.

Installing the Battery

1. Install the battery on the right rear fender with the negative post to the rear.
2. Install the battery mount bracket and torque the bolt to 31 ft-lbs (42 Nm).
3. Apply dielectric grease and connect the positive battery cable to the positive battery post first.
4. Apply dielectric grease and connect the negative battery cable to the negative battery post last.
5. Place the covers back over the battery terminals.
6. Close the right door.

Cleaning the Battery and Terminals

1. Park the power unit on a level surface.
2. Engage the parking brake and shut off the engine.
3. Remove the key from the ignition switch.
4. Open the right door.
5. Disconnect and remove the battery.
6. Wash the battery with a solution of 4 tablespoons (59 mL) of baking soda to 1 gallon (3.8 L) of water. Be careful not to get the soda solution into the cell.
7. Rinse the battery with clean water and dry.
8. Clean the battery posts and battery cable terminals with a wire brush.
9. Reinstall the battery in the power unit.
10. Place the covers back over the battery terminals.
11. Close the right door.

Charging the Battery

⚠ DANGER

Batteries produce explosive gases. Charge the battery in a well ventilated space where the gases produced by charging can dissipate. Do not charge where the battery could be exposed to sparks, open flames, or other sources of ignition.

Never charge a frozen battery, as it may explode. Allow the battery to warm up and inspect for cracks or damage before charging.

To preserve optimum battery performance and life, do not allow the battery to stand in a discharged state for long periods of time. If the battery is not being used, check the battery voltage every 30 days and recharge the battery if the voltage drops to 12.4 volts or lower.

Keep the battery fully charged in cold weather to prevent damage due to freezing.

1. If possible, remove the battery from the power unit before charging.
2. Refer to the battery charger's manual for specific charging instructions.
3. If electrolyte is expelled or excessive gassing occurs, or if the temperature of the battery exceeds 125° F (52° C), charging must be temporarily stopped to permit cooling. After cooling, reduce the charging rate before starting the charger again.

SERVICE

Jump Starting Procedure

⚠ DANGER

The battery produces a flammable and explosive gas. The battery may explode.

- Wear eye protection and gloves.
- Do not jump start a cold or frozen battery. Allow the battery to warm up and inspect for cracks or damage.
- Do not jump start a cracked or damaged battery.
- Do not attempt to jump start the power unit using a battery of a different voltage.

1. Inspect the discharged battery for terminal corrosion and loose connections. Clean terminals and tighten connections prior to jump starting.
2. Make sure the vehicle used to jump start the power unit has a 12 volt, negative ground, electrical system.
3. Pull the boosting vehicle up close to the disabled power unit. Be sure the vehicles do not touch.
4. Shut off the boosting vehicle's engine and set the parking brake.

⚠ CAUTION

Attempting to start the disabled unit with the boosting vehicle's engine running could cause damage to the regulator.

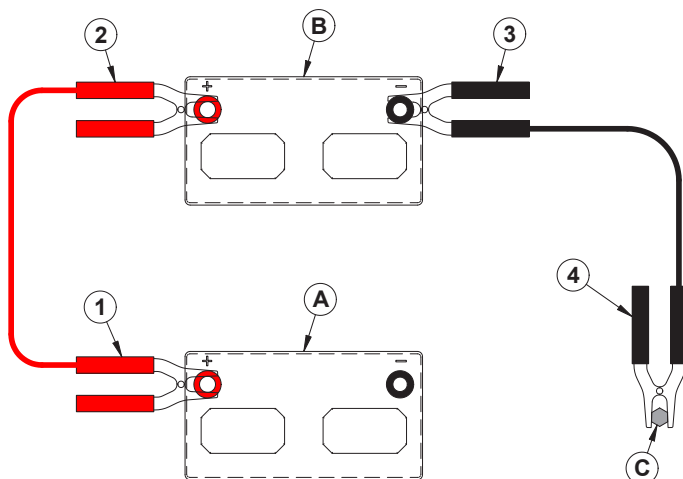

A. Discharged Battery
B. Booster Battery

C. Ground Stud

5. Connect one end of the positive (+) booster cable to the discharged battery's positive (+) terminal (1).
6. Connect the other end of the positive (+) booster cable to the booster battery's positive (+) terminal (2).

7. Connect the negative (-) booster cable to the booster battery's negative (-) terminal (3).
8. Connect the other end of the negative (-) booster cable to the disabled power unit's ground stud (4).
9. Start the disabled power unit and remove the booster cables in reverse order of installation (negative booster cable first).

Replacing Fuses

1. Park the power unit on a level surface.
2. Engage the parking brake and shut off the engine.
3. Remove the key from the ignition switch.
4. Press the button on the battery disconnect switch.
5. Open the right door.
6. Remove the cover (A) from the fuse panel.
7. Identify and pull the defective fuse from the socket. Fuse positions are printed on the fuse panel cover.



Fuse Panel

Position	Fuse	Circuit
1	5 amp	USB / Cluster Gauge
2	10 amp	Ignition Switch
3	30 amp	Fuse Block Distribution
4	25 amp (CB)	Hydraulic Cooling Fan
5	10 amp	Work Lights
6	15 amp	Operation Interlock System
7*	10 amp	PTO
8*	15 amp	Brine Pump
9	30 amp	Voltage Regulator
10*	10 amp	12 Volt Aux. Hydraulics
11*	20 amp	12 Volt 4-Pin Front
12	10 amp	Starter / Hyd. Cooler Relay
13*	10 amp	Spreader
14	-	Spare
15	-	Spare
16	-	Spare

*Optional accessory.

(CB) = Circuit Breaker

8. Insert a new fuse into the socket. Be sure to use the correct amperage fuse or damage may occur to the power unit.
9. Reinstall the sealed cover onto the fuse panel and close the right door.
10. Reset the battery disconnect switch.

SERVICE

Replacing the Headlights and Work Lights

The headlights and the optional work lights are equipped with LEDs and do not use a replaceable bulb. If a headlight or work light no longer functions, the entire light must be replaced.

Belt Inspection

Inspecting the belts of this power unit can prevent sudden belt failure by finding problems before they cause a belt to break. Inspect belts prior to operation, as part of the daily inspection or anytime a problem is suspected. There may be a belt problem if there is a squealing or chattering sound or the smell of a slipping belt.

The belts used on this power unit are a hydraulic pump drive belt and an optional PTO drive belt.

The pump drive belt (A) can be inspected by opening the left door and checking the belt at the pump drive pulley. Removing the pump belt drive shield and disengaging the belt tension spring will allow the belt to be removed from the pump drive pulley for easier inspection.

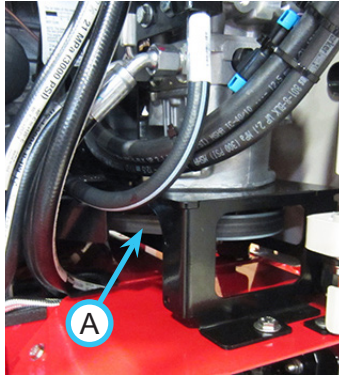

The PTO drive belt (B) can be inspected at the front hitch. Typical wear on a drive belt may result in the conditions shown in the diagram. If any of these conditions occur, the drive belt will require replacement.

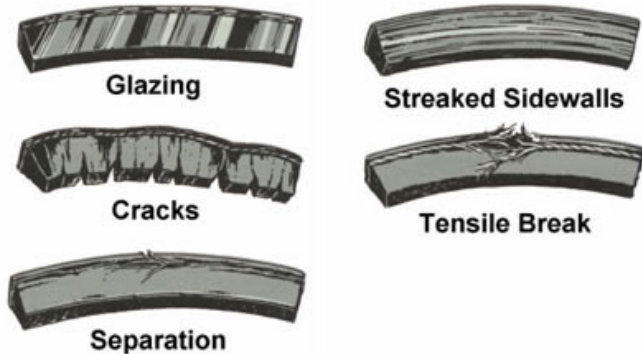
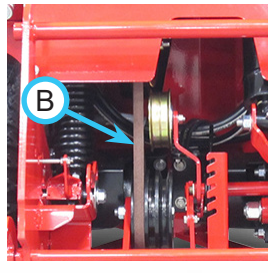

Pump Drive Belt Replacement

1. Park the power unit on a level surface.
2. Engage the parking brake and shut off the engine.
3. Remove the key from the ignition switch.
4. If the power unit is not equipped with a PTO kit, skip to step 12. If the power unit is equipped with a PTO kit, follow the steps below.
5. Remove the PTO drive cover.
6. Remove the front, left, and right engine covers.
7. Remove the PTO belt cover.
8. Remove the center fender platform (A) from the right side of the power unit.

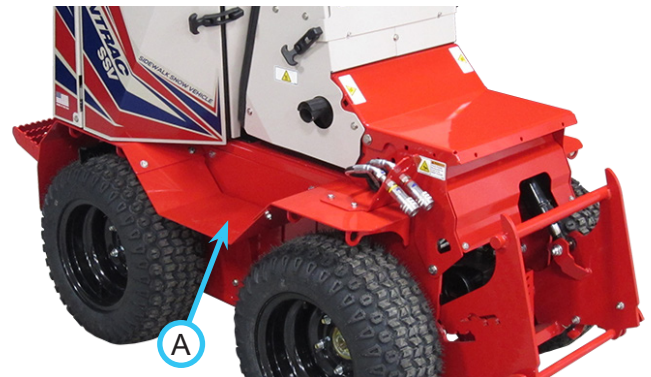

9. Use a 3/8" drive ratchet to rotate the PTO belt tension arm far enough to remove the belt from the belt tension pulley.
10. Remove the PTO belt from the clutch pulley.
11. Remove the bolts that fasten the clutch torque bracket (B) to the engine mount frame.
12. Reach through the hole in the right frame side cover and unplug the PTO wire harness connector (C) from the clutch.

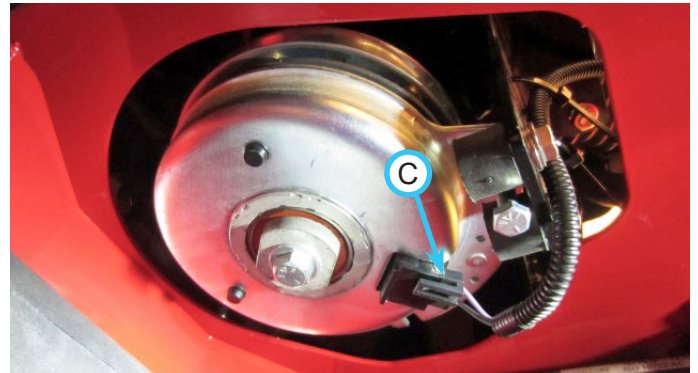
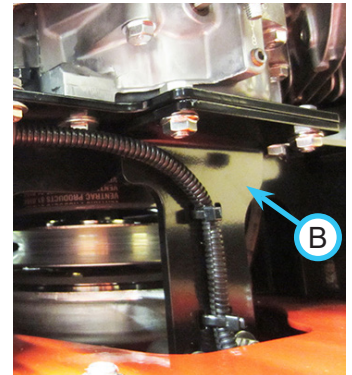

13. Remove the operator cushion.

SERVICE

14. Remove the pump drive belt cover.
15. Disengage the pump belt tension spring.
16. Open the left door.
17. Remove the pump belt from the pump drive pulley.
18. Remove the pump belt from the engine pulley and pull down over the PTO clutch (if equipped) to remove.
19. Install the new pump belt onto the engine pulley and pump pulley.
20. Ensure the belt is properly seated in the pulleys and engage the belt tension spring.
21. If the power unit is not equipped with a PTO kit, skip to step 27.
22. Reinstall the clutch torque bracket onto the engine mount frame. Make sure the anti-rotation bolt on the clutch is located between the rubber bumpers on the clutch torque bracket. Torque bolts to 210 in-lbs (24 Nm).
23. Reconnect the PTO wire harness to the clutch.
24. Reinstall the PTO belt onto the clutch pulley.
25. Use a 3/8" drive ratchet to rotate the PTO belt tension arm far enough to install the belt onto the belt tension pulley.
26. Reinstall the PTO belt cover and the PTO drive cover. Torque the bolts to 100 in-lbs (11 Nm).
27. Reinstall the center fender platform and torque the bolts to 210 in-lbs (24 Nm).
28. Reinstall the left, right, and front engine covers and torque the bolts to 100 in-lbs (11 Nm).
29. Reinstall the pump belt drive cover and torque the bolts to 100 in-lbs (11 Nm).
30. Reinstall the operator cushion.
31. Close the left door.

PTO Drive Belt Replacement

1. Park the power unit on a level surface.
2. Engage the parking brake and shut off the engine.
3. Remove the key from the ignition switch.
4. Remove the PTO drive cover.
5. Remove the front, left, and right engine covers.
6. Remove the PTO belt cover.
7. Use a 3/8" drive ratchet to rotate the PTO belt tension arm far enough to remove the belt from the belt tension pulley.
8. Remove the PTO belt from the clutch pulley. Pull the belt end down around the clutch body, then pull forward and up between the clutch torque bracket and the power unit frame.
9. Remove the belt from the front idler pulleys.

10. Install the new belt by sliding one end of the belt down through the main frame in front of the clutch torque bracket. Pull the end back underneath the bracket and install onto the clutch pulley.
11. Route the belt forward to the idler pulleys. Twist the belt so the left side of the belt lays in the v-idler pulley and the back of the right side of the belt lays against the flat idler pulley.
12. Use a 3/8" drive ratchet to rotate the PTO belt tension arm far enough to install the belt onto the double idler pulley. Position in the groove next to the pulley mounting bracket.
13. Reinstall the PTO belt cover and the PTO drive cover. Torque the bolts to 100 in-lbs (11 Nm).
14. Reinstall the left, right, and front engine covers and torque the bolts to 100 in-lbs (11 Nm).

Wheel Removal & Installation

Wheel Removal:

1. Park the power unit on a level surface.
2. Engage the parking brake and shut off the engine.
3. Remove the key from the ignition switch.
4. Loosen the wheel lug nuts, but do not remove.
5. Lift up the power unit to raise the wheel off the ground and secure with a jack stand.
6. Remove the lug nuts and lift the wheel off the mounting studs.

Wheel Installation:

1. Place the wheel onto the mounting studs with the hub side of the rim against the motor hub. NOTE: the valve stem will be to the outside of the power unit.
2. Install the lug nuts and tighten by hand until the wheel is held against the axle hub.
3. Lift the power unit up slightly and remove the jack stand. Lower the power unit to the ground.
4. Tighten the wheel nuts in a crisscross sequence as shown. Torque to 85 ft-lbs (115 Nm).

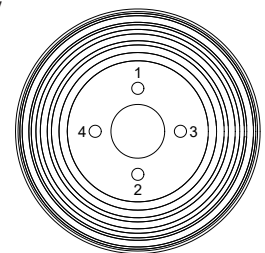

Tire Pressure

Maintain tire pressure at 18 psi (124 kPa). Check the tire pressure prior to operation, as part of the daily inspection. Keep tires evenly inflated. Keep tires inflated to the proper pressure to prevent premature wear and/or poor traction.

SERVICE

Parking Brake Adjustment

As the tire tread wears down, the parking brake grip plates will need to be adjusted in order to hold securely. The brake plates are located between the rear tires and fenders.

1. Park the power unit on a level surface.
2. Engage the parking brake and shut off the engine.
3. Remove the key from the ignition switch.

WARNING

The parking brake must be disengaged as part of the adjustment procedure. Park the power unit on a level surface and place wheel chocks in front and back of the wheels to prevent the power unit from rolling forward or backward.

4. Place wheel chocks in front and back of wheels to prevent power unit from rolling during adjustment procedure.
5. Disengage the parking brake.
6. Remove the bolts (A) that fasten the brake grip plate to the brake bar.

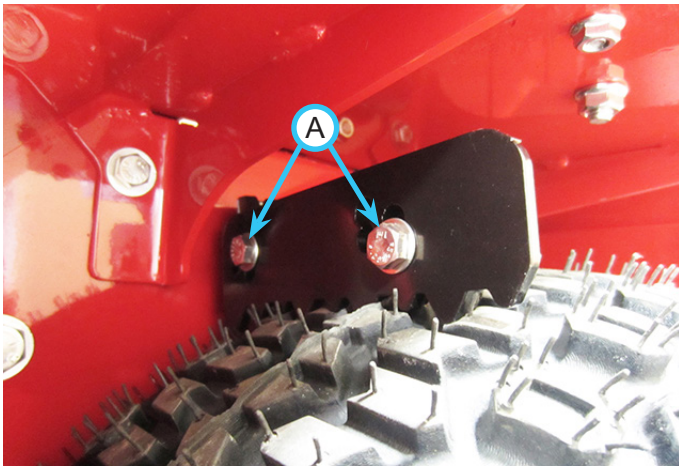

7. Use the next set of holes in the grip plate to position the grip plate closer to the tire and reinstall onto the brake bar. Torque the bolts to 210 in-lbs (24 Nm). Repeat on opposite side of power unit.
8. Engage the parking brake and remove the wheel chocks.

Parking Brake Switch Adjustment

An improperly adjusted parking brake switch can prevent the engine from cranking. If the parking brake is engaged, but the parking brake indicator light on the cluster gauge is not activated, the parking brake switch will need to be adjusted.

1. Engage the parking brake.
2. Open the right door.
3. Loosen the hardware (A) that fastens the parking brake switch bracket to the frame panel.

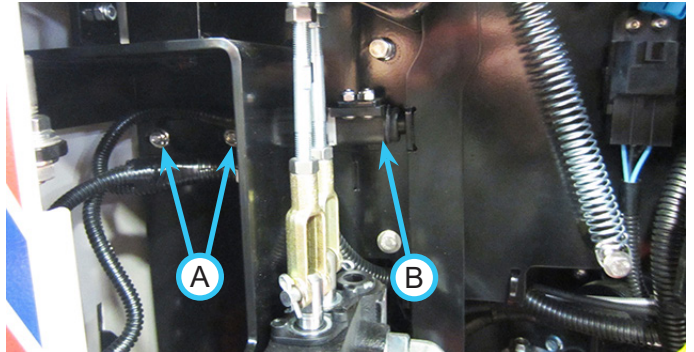

4. Position the bracket so the switch (B) is activated by the parking brake link and tighten the hardware to secure the switch bracket.
5. Turn the ignition key to the On position and check the cluster gauge to verify the parking brake indicator light is activated.
6. Torque the mounting bolts to 100 in-lbs (11 Nm) and close the right door.

SERVICE

Operator Presence Switch Adjustment

⚠ WARNING

An improperly adjusted operator presence switch can prevent the power unit from operating or can allow unsafe power unit movement and operation.

1. Park the power unit on a level surface.
2. Engage the parking brake and shut off the engine.

⚠ WARNING

The parking brake must be disengaged as part of the adjustment procedure. Park the power unit on a level surface and place wheel chocks in front and back of the wheels to prevent the power unit from rolling forward or backward.

3. Place wheel chocks in front and back of wheels to prevent power unit from rolling during adjustment procedure.
4. Loosen the hardware that fastens the platform switch bracket (A) to the frame.

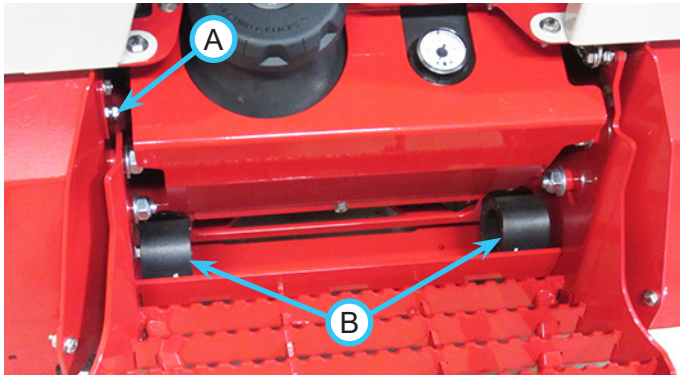

5. Move the switch bracket up or down in small increments. If the power unit fails test number 9 in the Safety Interlock System section, the switch bracket must be moved up away from the platform. If the engine shuts off when the parking brake is disengaged but the operator is present on the platform, the switch bracket will need to be moved down toward the platform.
6. Disengage the parking brake.
7. Turn the ignition key to the On position, but do not start the engine.
8. Move the operator platform down until a click can be heard from the relay in the fuse panel and note the position of the platform.
9. Adjust the switch bracket until the relay activates at approximately the position when the operator platform contacts the elastomer springs (B) on the power unit frame.

10. After adjustment is complete, torque the platform switch bracket hardware to 100 in-lbs (11 Nm).
11. Engage the parking brake, turn the ignition key to the Off position, and remove the wheel chocks.

Drive Control Handle Adjustment

Drive tracking and top forward speed are controlled by the pump stop bolt (A) on both pumps. The drive control handles should be adjusted to have a 1/16" (1.5 mm) gap between the handle and the front grab bar when the linkage contacts the pump stop bolt.

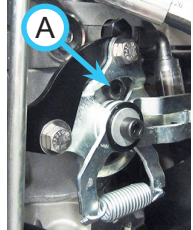

To check and adjust the drive control handles:

1. Park the power unit on a level surface.
2. Engage the parking brake and shut off the engine.
3. Remove the key from the ignition switch.
4. Move each drive control handle forward by pushing against the handle where it comes through the dash. Check the distance of the gap between the knob on the drive handle and the front grab bar.
5. If the drive control handle needs to be adjusted, remove the operator cushion.
6. Remove the four bolts that fasten the left rear tower cover (B) to the power unit and remove the cover to access the pump control links.
7. Loosen the jam nuts (C) from the rod ends on the pump link rod. NOTE: one end uses left hand threads.
8. Adjust the drive control handle by turning the pump link rod. Lengthen the rod to move the handle toward the front grab bar. Shorten the rod to move the handle away from the grab bar.
9. When adjustment is complete, tighten the jam nuts against the rod ends.
10. After adjustment is complete for both drive control handles, reinstall the left rear tower covers. Torque the bolts to 100 in-lbs (11 Nm).
11. After any adjustments are made to the drive control handles, the neutral arm and the neutral switch must be inspected and adjusted.

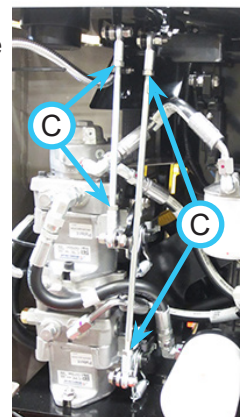
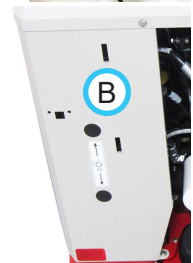

SERVICE

Neutral Arm Adjustment

1. Park the power unit on a level surface.
2. Engage the parking brake and shut off the engine.
3. Remove the key from the ignition switch.
4. Remove the operator cushion.
5. With the drive control handles in the neutral position, check the neutral arm (A) position for each drive handle. The riser tip on each neutral arm must be centered below the bearing (B) on the drive control handle.

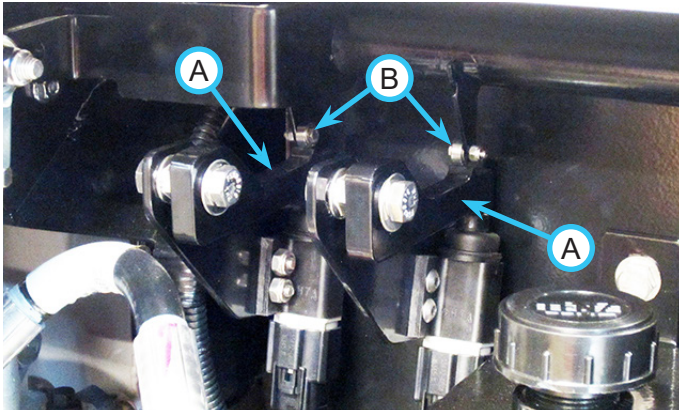

Move each drive control lever forward and backward. If the neutral arm moves down when the handle is moved, the riser tip is not centered under the bearing.

6. If the neutral arm needs to be adjusted, loosen the nut (C) that clamps the neutral arm bolt to the neutral bracket.

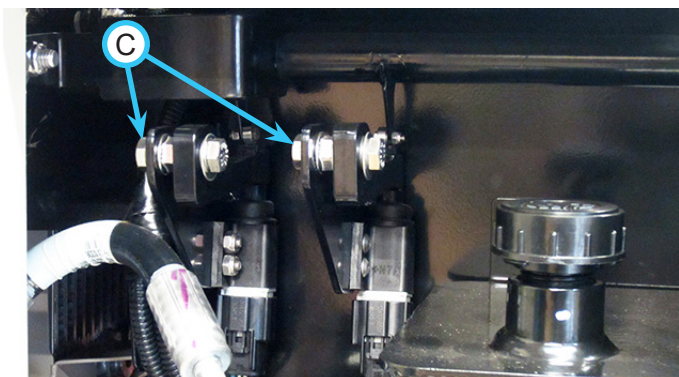

7. Move the neutral arm forward or backward to center the riser tip under the bearing. When the neutral arm is positioned correctly, torque the nut to 31 ft-lbs (42 Nm).
8. After both neutral arms have been adjusted, inspect and adjust the neutral switches.

Neutral Switch Adjustment

1. Park the power unit on a level surface.
2. Engage the parking brake and shut off the engine.
3. Remove the key from the ignition switch.
4. Remove the operator cushion.
5. There is a neutral switch (A) for both the left and right drive control handles. Adjust only one neutral switch at a time. Loosen the machine screws that fasten the neutral switch to the mounting bracket.

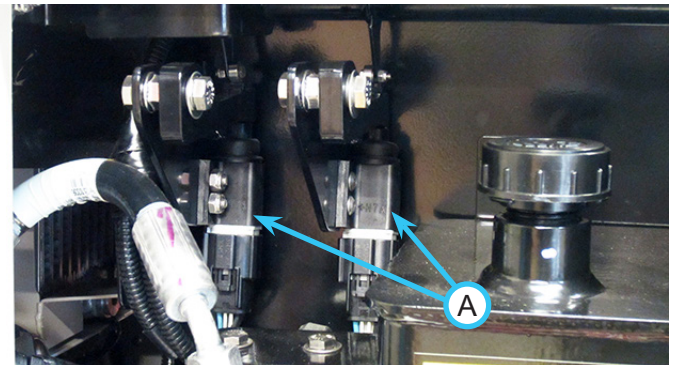

6. Move the switch up or down as necessary and retighten the machine screws. The neutral switch should be set to disengage with 1/4 - 3/4" (6.5 - 19 mm) forward or backward movement of the drive control handle.
7. After both neutral switches have been adjusted, reinstall the operator cushion.

SERVICE

Storage

Preparing the Power Unit for Storage

1. Clean the power unit.



Attention

To maintain the finish of the power unit, thoroughly wash the equipment to remove any corrosive agents (e.g., salt). Failure to clean the equipment may result in corrosion of (including but not limited to) steel, aluminum, and electrical components.

2. Inspect for loose or missing hardware, damaged components, or signs of wear.
3. Inspect safety decals. Replace any safety decals that are faded, illegible, or missing.
4. Inspect hydraulic hoses for leaks and/or wear. Service as required.
5. Inspect hydraulic hoses, hydraulic fittings, and fuel lines to ensure tight, leak free connections.
6. Ensure parking brake plates are properly adjusted.
7. Inspect the electrical system and connections.
8. Test the operator safety interlock system.
9. Inspect belts and pulleys for damage or excessive wear. Service as required.
10. Check the hydraulic oil level. Add fluid or service as required.
11. Ensure the air cleaner and engine compartment are clean.
12. Check tires for proper inflation.
13. Grease and lubricate all points specified in the Lubrication Locations section. Wipe off any excess grease or oil.
14. Inspect painted surfaces for chips, scratches, or rust. Clean and touch up surfaces as needed.

After all the above steps have been performed, complete the preparation for storage by performing the steps for either long term storage (4 months or longer) or short term storage (less than 4 months).

Long Term Storage (4 Months or Longer)

1. Change the engine oil to prevent damage that can be caused by acidic build up in used motor oil.
2. Drain all fuel out of the fuel tank, start the power unit, and allow to run until the engine stops to ensure all fuel is out of fuel lines, carburetor passages, etc.
3. Turn the key to the Off position and remove.
4. Engage the parking brake.
5. Turn the fuel shut-off valve to the Off position.
6. Press the button on the battery disconnect switch.
7. If the power unit is being stored in a cold climate (below 35° F (2° C)), remove the battery from the power unit and store in a warm location. Check the battery charge level periodically and charge the battery, if necessary.

Short Term Storage (Less than 4 Months)

1. Add a quality fuel stabilizer to the fuel tank. Follow the manufacturer's recommended mixing ratios. Start the power unit's engine and run for 10 minutes to allow the fuel stabilizer to travel all through the fuel system.
2. Turn off the power unit engine and remove the key from the ignition.
3. Engage the parking brake.
4. Turn the fuel shut-off valve to the Off position.
5. Press the button on the battery disconnect switch.
6. Check the battery charge level periodically and charge the battery, if necessary.

Removing the Power Unit from Storage

1. Clean the power unit to remove any accumulated dust or debris.
2. Inspect the power unit as instructed in the Daily Inspection section of this manual.
3. Test the power unit to ensure all components are working properly.

SERVICE

Maintenance Schedule

Maintenance Schedule	# of Locations	Number of Pumps AS NEEDED	After First 8 Hrs. Daily	At 50 Hours	At 100 Hours	At 150 Hours	At 200 Hours	At 250 Hours	At 300 Hours	At 350 Hours	At 400 Hours	At 450 Hours	At 500 Hours	At 550 Hours	At 600 Hours	At 650 Hours	At 700 Hours	At 750 Hours	At 800 Hours	At 850 Hours	At 900 Hours	At 950 Hours	At 1000 Hours	Yearly	1500 Hours%
Grease & Lubrication: See Lubrication Section																									
Front Hitch	2	1	✓	✓	✓	✓	✓	✓	✓	✓	✓	✓	✓	✓	✓	✓	✓	✓	✓	✓	✓	✓	✓	✓	✓
Lift Cylinder	2	1	✓	✓	✓	✓	✓	✓	✓	✓	✓	✓	✓	✓	✓	✓	✓	✓	✓	✓	✓	✓	✓	✓	✓
Operator Platform Pivot	2	#	✓	✓	✓	✓	✓	✓	✓	✓	✓	✓	✓	✓	✓	✓	✓	✓	✓	✓	✓	✓	✓	✓	✓
Spherical Rod Ends	6	#	✓	✓	✓	✓	✓	✓	✓	✓	✓	✓	✓	✓	✓	✓	✓	✓	✓	✓	✓	✓	✓	✓	✓
Engine ¹																									
Check Engine Oil Level			✓																						
Change Engine Oil & Filter ¹		✓		✓	✓	✓	✓	✓	✓	✓	✓	✓	✓	✓	✓	✓	✓	✓	✓	✓	✓	✓	✓	✓	✓
Clean/Replace Spark Plugs	Consult Engine Owner's Manual*																								
Clean Foam Air Filter	Clean Foam Air Filter every 25 hours																								
Replace Paper Air Filter	**			✓	✓	✓	✓	✓	✓	✓	✓	✓	✓	✓	✓	✓	✓	✓	✓	✓	✓	✓	✓	✓	✓
Service Engine: Remove air cleaner cover. Inspect and Clean	**		✓	✓	✓	✓	✓	✓	✓	✓	✓	✓	✓	✓	✓	✓	✓	✓	✓	✓	✓	✓	✓	✓	✓
Clean Engine Compartment, Engine, and Engine Rotating Screen	**	✓																							
Replace Fuel Filter	✓								✓																
Drain Water & Sediment from Fuel Tank	✓																								✓
Hydraulic System																									
Check Hydraulic Oil Level			✓																						
Change Hydraulic Filters [%]													✓												✓
Change Hydraulic Oil [%]													✓												✓
Parking Brake																									
Parking Brake Inspection & Adjustment			✓																						
Electrical																									
Clean Battery Terminals & Compartment	✓																								✓
Inspection																									
Inspect Operator Interlock System			✓																						
Inspect Safety Decals			✓																						
Inspect for Loose, Missing, or Worn Components			✓																						
Inspect Battery, Electrical Connections, and Lights			✓																						
Inspect Belts, Fuel Lines, and Hydraulic Lines			✓																						
Check Tire Pressure.			✓																						
Check Wheel Lug Nuts. Torque to 85 ft-lbs (115 Nm)				✓	✓			✓			✓				✓				✓						
Check Front Hitch Pivot Bolts. Torque to 150 ft-lbs (203 Nm)				✓	✓	✓	✓	✓	✓	✓	✓	✓	✓	✓	✓	✓	✓	✓	✓	✓	✓	✓	✓	✓	✓
* Ventrac recommends servicing more frequently at 1/2 the standard service interval.																									
** Operation in severe conditions may require more frequent service intervals.																									
¹ Consult Engine Owner's Manual for engine oil information and complete servicing information																									
# Silicon Based Spray Lubricant																									
% Hydraulic oil & filters: initial change @ 500 hours. Then change oil and filters every 1000 hours. .																									

SERVICE

Maintenance Checklist

Maintenance Checklist	# of Locations	Number of Pumps	AS NEEDED	After First 8 Hrs.	Daily	At 50 Hours	At 100 Hours	At 150 Hours	At 200 Hours	At 250 Hours	At 300 Hours	At 350 Hours	At 400 Hours	At 450 Hours	At 500 Hours	At 550 Hours	At 600 Hours	At 650 Hours	At 700 Hours	At 750 Hours	At 800 Hours	At 850 Hours	At 900 Hours	At 950 Hours	At 1000 Hours	Yearly	1500 Hours ^o
Grease & Lubrication: See Lubrication Section																											
Front Hitch	2	1																									
Lift Cylinder	2	1																									
Operator Platform Pivot	2	#																									
Spherical Rod Ends	6	#																									
Engine ¹																											
Check Engine Oil Level																											
Change Engine Oil & Filter ¹																											
Clean/Replace Spark Plugs	Consult Engine Owner's Manual*																										
Clean Foam Air Filter (every 25 hours)																											
Replace Paper Air Filter																											
Service Engine: Remove air cleaner cover. Inspect and Clean																											
Clean Engine Compartment, Engine, and Engine Rotating Screen																											
Replace Fuel Filter																											
Drain Water & Sediment from Fuel Tank																											
Hydraulic System																											
Check Hydraulic Oil Level																											
Change Hydraulic Filters ^o																											
Change Hydraulic Oil ^o																											
Parking Brake																											
Parking Brake Inspection & Adjustment																											
Electrical																											
Clean Battery Terminals & Compartment																											
Inspection																											
Inspect Operator Interlock System																											
Inspect Safety Decals																											
Inspect for Loose, Missing, or Worn Components																											
Inspect Battery, Electrical Connections, and Lights																											
Inspect Belts, Fuel Lines, and Hydraulic Lines																											
Check Tire Pressure.																											
Check Wheel Lug Nuts. Torque to 85 ft-lbs (115 Nm)																											
Check Front Hitch Pivot Bolts. Torque to 150 ft-lbs (203 Nm)																											
* Ventrac recommends servicing more frequently at 1/2 the standard service interval.																											
** Operation in severe conditions may require more frequent service intervals.																											
! Consult Engine Owner's Manual for engine oil information and complete servicing information																											
# Silicon Based Spray Lubricant																											
% Hydraulic oil & filters: initial change @ 500 hours. Then change oil and filters every 1000 hours. .																											

TROUBLESHOOTING

Wiring Diagram Reference Key

Harness Section Identifier

A = 32.0178 - Harness, Wire NT Main
B = 32.0187 - Harness, Wire NT PTO
C = 32.0186 - Harness, Wire NT 12V 4-Pin Front
D = 32.0189 - Harness, Wire NT Brine System
E = 32.0188 - Harness, Wire NT Dual Aux. Hydraulics

----- = ^Black Wire
_____ = White Wire
|||_____ = Ground
● = Splice or Connection

Wire Color & Circuit Type

Black = Ground
Lt Blue = Safety Circuit
Brown = Engine Run / Kill
Gray = 12v Aux / Horn power
Green = Start/Speed/Directional
Lt Green = 12 Aux
Pink = Alarm
Purple = PTO
Red = Keyed Power
White = Power (Direct to Battery)
Yellow = Light

° All black wires that are part of the wire harness are part of the ground circuit. However, some components such as lights may be wired where black may be positive.

*Components/breakout should be covered in High temp Loom rating =>500°

All other wire colors are as shown

Anything outlined with a blue box is a Standard Feature

Anything outlined with a Green box is an Option

Relay Layout - For Proper Installation.

(Note - View is looking at bottom of relays)



TROUBLESHOOTING

Wiring Harness Diagram

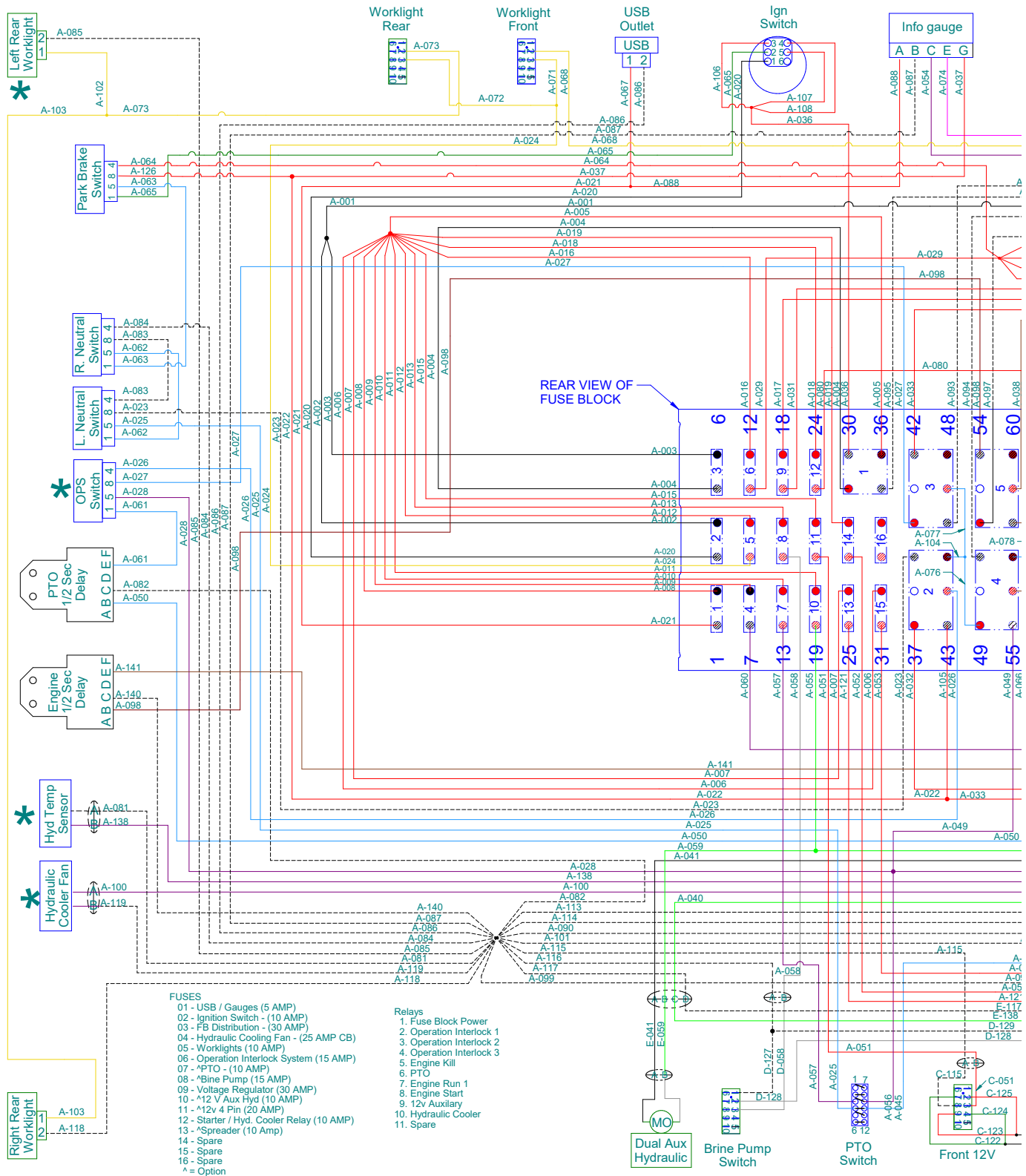

Revision 05

TROUBLESHOOTING

Wiring Harness Diagram

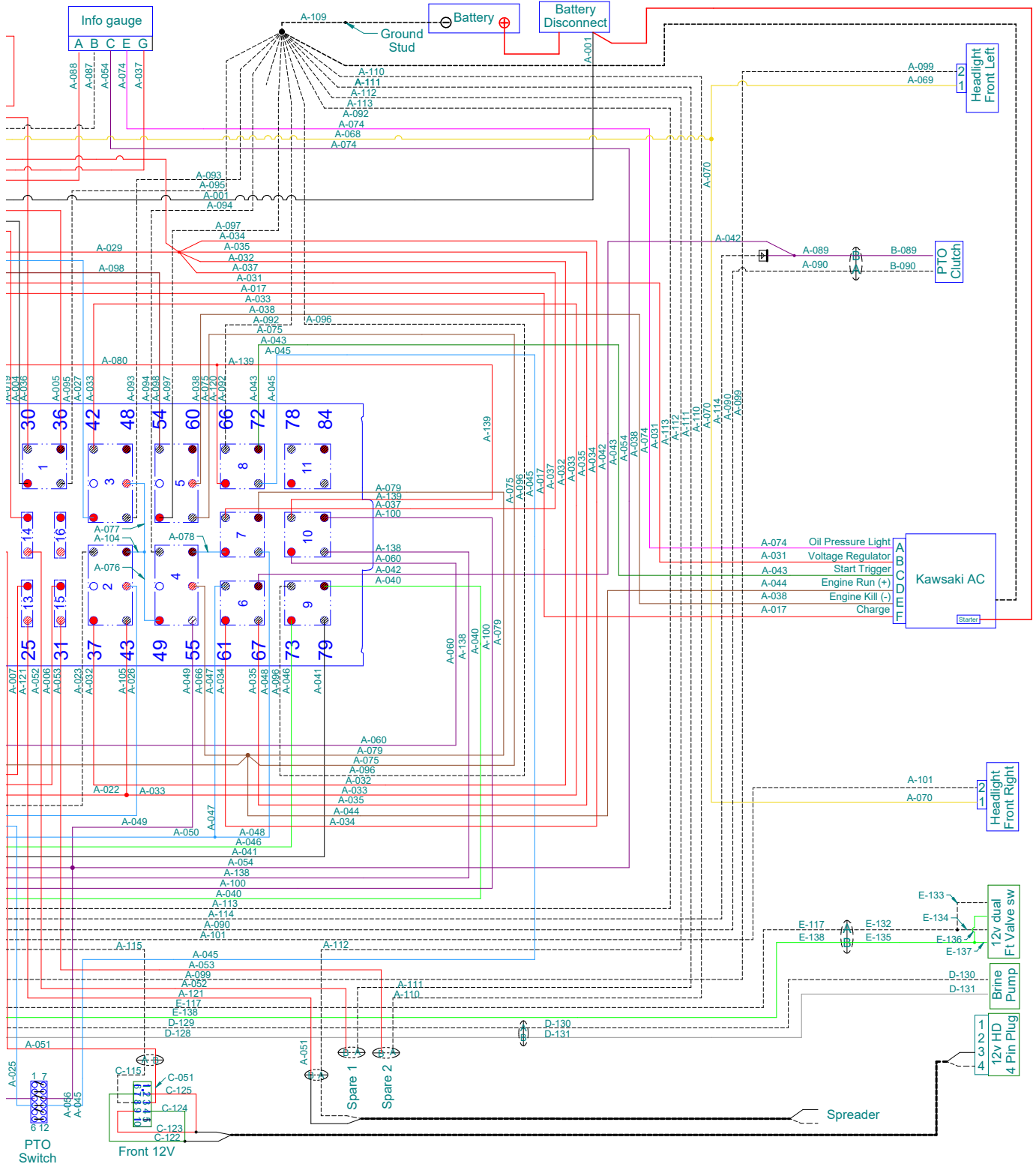

Revision 05

TROUBLESHOOTING

Wiring Diagram - Optional 30.0219 4-Pin Female Socket & 30.0218 4-Pin Male Plug

Attention

This connector (4-pin socket) is designed for use with Ventrac original equipment only. This connector (4-pin socket) is rated for 20 amp maximum current draw. Engine alternator and/or battery capacity determine allowable continuous draw.

30.0219 4-pin female socket is used in the 70.6006 12 Volt Front Kit.

**Front View of Socket
Without Cover**

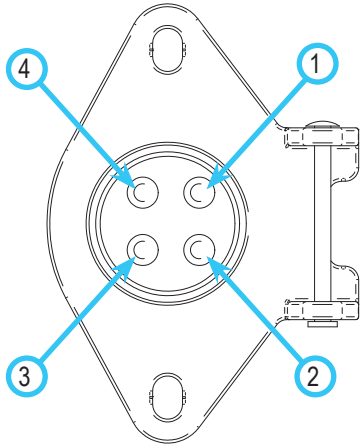

Rear View of Socket

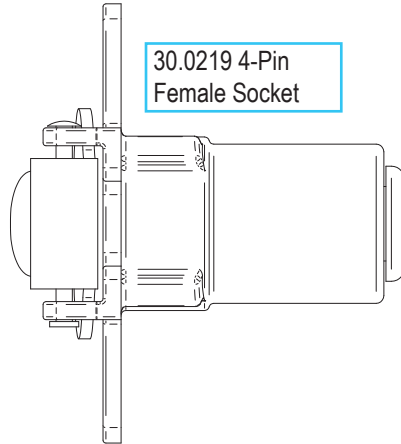
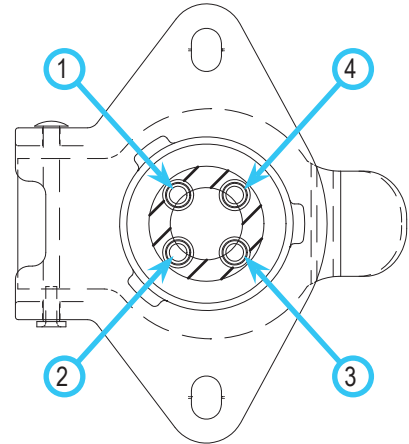

Terminal Position	Wire Color	Function
1	-	-
2	-	-
3	Green	Positive/Negative (Momentary Switched Reversing)
4	Red	Positive/Negative (Momentary Switched Reversing)

30.0218 4-pin plug is used on attachments to connect to the 30.0219 socket on the power unit.

Front View of Plug

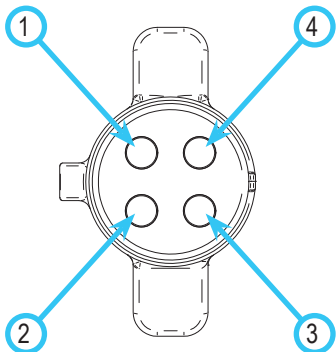

Rear View of Plug

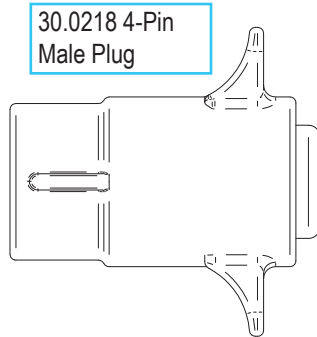
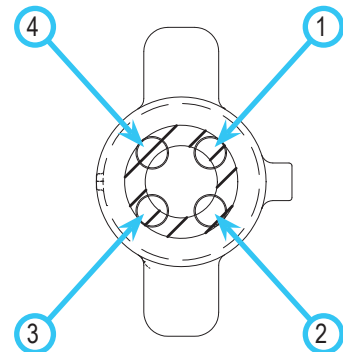

Terminal Position	Wire Color	Function
1	-	-
2	-	-
3	Black	Positive/Negative (Momentary Switched Reversing)
4	White	Positive/Negative (Momentary Switched Reversing)

TROUBLESHOOTING

Engine

Symptom:	Possible Cause:
Starter will not engage.	Battery disconnect switch in Off position. PTO switch is engaged. Blown fuse in start circuit. Parking brake is not engaged. Parking brake switch is out of adjustment. Power unit not in neutral. Neutral switch(es) out of adjustment. Low battery voltage.
Engine cranks, but won't start.	Fuel shut-off valve is turned off. Insufficient fuel level. Faulty fuel pump. Plugged fuel filters. Obstruction in the fuel line. Poor engine compression.
Engine runs rough.	Plugged or partially plugged air filters. Plugged or partially plugged fuel filters. Stale, dirty fuel OR wrong seasonal fuel mixture. Insufficient fuel level. Faulty spark plugs. Moisture in spark plug pockets. Incorrect choke setting. Faulty fuel pump. Incorrect valve clearance. Valve seat failure.
Engine low on power.	Plugged or partially plugged air filters. Plugged or partially plugged fuel filters. Dirty or faulty carburetor. Low cylinder compression.
Engine overheats.	Debris in engine compartment.
Oil light comes on when running.	Low oil level. Faulty oil sender. Faulty or plugged oil pump.
Engine emits white smoke.	Low engine temperature.
Excessive fuel consumption.	Plugged or restricted air filters or hose. Dirty or faulty carburetor.
Engine uses excessive oil.	Check for leaks. Incorrect oil viscosity. Plugged or restricted air filters and or hose. Worn rings or cylinder walls. Worn or faulty valves.

TROUBLESHOOTING

Electrical

Symptom:	Possible Cause:
Battery does not charge.	Loose or corroded connections. Broken or loose wire in charge system. Blown fuse in charge system. Defective battery. Defective regulator. Defective alternator.
Lights do not activate.	Blown fuse. Broken wire. Defective light switch. Defective light.
PTO does not engage.	Blown fuse. Operator not on platform. Defective or out of adjustment operator presence switch. Faulty PTO switch. Faulty PTO relay. PTO belt failure. Faulty clutch.

Hydraulic

Symptom:	Possible Cause:
Front attachment does not lift.	Hydraulic oil level is low. Excessive load on front lift. Plugged hydraulic oil suction filter. Faulty hydraulic cylinder. Pump charge pressure is low. Hardware missing on lift cylinder. Hardware missing on hydraulic control lever links.
Excessive noise in hydraulic system.	Hydraulic oil level is low. Plugged hydraulic oil suction filter. Wrong oil used in hydraulic system. Cold weather - allow power unit to warm up.
Cooler fan not working / hydraulic system overheat	Tripped circuit breaker for hydraulic cooling fan. Dirty/plugged hydraulic cooler. Faulty cooling fan temperature sender. Faulty cooling fan. Overstressing the hydraulic system.

TROUBLESHOOTING

Power Unit

Symptom:	Possible Cause:
Power unit will not move with engine running.	Hydraulic oil level is low. Parking brake is engaged. Pump control rod linkage loose or off. Hydraulic pump bypass valve is open. Pump drive belt failure. Faulty hydraulic pump or motor.
Engine stalls when the drive control handles are moved forward or backward out of neutral.	Parking brake is engaged. Defective or out of adjustment parking brake switch. Defective or out of adjustment operator presence switch.
Engine stalls when the parking brake is disengaged while operator is on platform.	Defective or out of adjustment operator presence switch.

SPECIFICATIONS

Engine

ManufacturerKawasaki
Model Number	FS600V
Type	Gasoline
Cylinders.	2
Displacement	36.8 cu. in (603 cc)
Engine Gross Power.	18.5 Hp (13.8 kW)
Peak Torque	32.5 ft-lbs (44 Nm) @ 2200 rpm
Operating Range (RPM).	1550 - 3600
Cooling System	Air Cooled
Alternator20 Amp

Electrical

Battery	500 Cold Cranking Amps
Voltage.	12 Volts

Power Train

Type	Hydrostatic (All Wheel Drive)
Forward Speed / Reverse Speed	8/6 mph (12.9/9.7 km/h)
Brakes	Hydro-Dynamic
Hydraulic Oil Filtration	10 Micron & 25 Micron

Controls & Instrument Panel

Throttle Control	Cable
Directional Control.	Right & Left Drive Control Handles
Gauges	Hour Meter, Fuel
Parking/Emergency Brake.	Tire Brake Bar
Optional PTO (Power Take Off)	Electric w/brake

Other Features

Tires	18 x 8.5-10 (46 x 22-26)
Headlight	LED Flood (1200 Lumen)
Attachment System	Quick Attach Hitch

Dimensions

Wheelbase.	28 inches (71 cm)
Overall Length	67 inches (170 cm)
Overall Height	55 inches (140 cm)
Overall Width	34 inches (86.4 cm)
Weight*970 pounds (440 kg)

Venture Products, Inc. reserves the right to change these specifications without notice.

*Weight varies based on setup (optional accessories).

SPECIFICATIONS

Fluid Capacities & Specifications

	Fluid Type	Capacity	Filter #1	Filter #2
Engine Oil	Synthetic 10W-30 ^{&}	1.8 quarts (1.7 liters)	-	-
Hydraulic Oil	HydroTorq XL Synthetic Hydraulic Oil	10 quarts (9.5 liters)	21.0122 (Suction filter)	21.0124 (Return filter)
Fuel System	Unleaded Gasoline (Max 10% Ethanol)	3.3 gallons (12.5 liters)	-	-
Grease	Lithium Complex NLGI #2	Refer to Maintenance Chart	-	-

[&] = use API Classification SJ or higher

Attention: Engine Oil Recommendation

For optimal engine life and performance, use Ventrac Full Synthetic Engine Oil.
Part # 15.0037-1



Belt Chart

Location	Belt Size	Ventrac Part Number
Pump Drive Belt	B41 Custom	81.0164
PTO Drive Belt (Optional)	B86 Custom	81.0167

WARRANTY



LIMITED WARRANTY - VENTRAC TURF EQUIPMENT

Venture Products, Inc., (henceforth referred to as V.P.I.) warrants on the terms and conditions herein, that it will repair, replace, or adjust any part manufactured by Venture Products Inc., and found by Venture Products, Inc., to be defective in material and/or workmanship during the applicable warranty term.

All Ventrac commercial equipment purchased and registered on or after January 1, 2019 will carry a 2-year commercial warranty. The warranty period begins on the date of original customer purchase:

Ventrac Commercial Equipment	Warranty Term
2100 SSV & Attachments	2-year
3000 Series Tractors & Attachments	2-year
4000 Series Tractors & Attachments	2-year

All Ventrac add-on kits and accessories such as: 3-point hitch, 12V front & rear power outlets, foot pedal, dual wheel kit, etc., will be covered under the above warranty periods provided they are installed by an Authorized Ventrac Dealer. This warranty may be transferred and will carry the remainder of the warranty starting from the original purchase/registration date with the dealership and/or V.P.I.

The engine warranty is covered by its respective engine manufacturer. Please refer to the engine manufacturer's warranty statement that is included in the owner's manual.

For warranty consideration on Ventrac commercial equipment, including any defective part, must be returned to an Authorized Ventrac Dealer within the warranty period. The warranty shall extend to the cost to repair or replace (as determined by V.P.I.) the defective part. The expense of pickup and delivery of equipment, service call drive time or any transportation expense incurred for warranty repair is the sole responsibility of the owner and is not covered under warranty by Ventrac and/or V.P.I. Ventrac and V.P.I.'s responsibility in respect to claims is limited to making the required repairs or replacements, and no claim of breach of warranty shall be cause for cancellation or rescission of the contract of sale of any Ventrac equipment. Proof of purchase may be required by the dealer to substantiate any warranty claim. Only warranty work performed and submitted by an Authorized Ventrac Dealer may be eligible for warranty credit.

This warranty extends only to Ventrac commercial equipment operated under normal conditions and properly serviced and maintained. The warranty expressly does NOT cover: (a) any defects, damage or deterioration due to normal use, wear and tear, or exposure; (b) normal maintenance services, such as cleaning, lubrication, oil change; (c) replacement of service items, such as oil, lubricants, spark plugs, belts, rubber hoses, bearings or other items subject to normal service replacement; (d) damage or defects arising out of, or relating to abuse, misuse, neglect, alteration, negligence or accident; (e) repair or replacement arising from operation of, or use of the equipment which is not in accordance with operating instructions as specified in the operator's manual or other operational instructions provided by V.P.I.; (f) repair or replacement arising as a result of any operation from Ventrac equipment that has been altered or modified so as to, in the determination of V.P.I., adversely affect the operation, performance or durability of the equipment or that has altered, modified or affected the equipment so as to change the intended use of the product; (g) repair or replacement necessitated by the use of parts, accessories or supplies, including gasoline, oil or lubricants, incompatible with the equipment or other than as recommended in the operator's manual or other operational instructions provided by V.P.I.; (h) repairs or replacements resulting from parts or accessories which have adversely affected the operation, performance or durability of the equipment; or (i) damage or defects due to or arising out of repair of Ventrac equipment by person or persons other than an authorized Ventrac service dealer or the installation of parts other than genuine Ventrac parts or Ventrac recommended parts.

WARRANTY



LIMITED WARRANTY - VENTRAC TURF EQUIPMENT

The sole liability of V.P.I. with respect to this warranty shall be the repair and replacement as set forth herein. V.P.I. shall have no liability for any other cost, loss, or damage. In particular V.P.I. shall have no liability or responsibility for: (i) expenses relating to gasoline, oil, lubricants; (ii) loss, cost or expense relating to transportation or delivery of turf equipment from the location of owner or location where used by owner to or from any Authorized Ventrac Dealer; (iii) travel time, overtime, after hours' time or other extraordinary repair charges or charge relating to repairs or replacements outside of normal business hours at the place of business of an Authorized Ventrac Dealer; (iv) rental of like or similar replacement equipment during the period of any warranty repair or replacement work; (v) any telephone or telegram charges; (vi) loss or damage to person or property other than that covered by the terms of this warranty; (vii) any claims for lost revenue, lost profit or additional cost or expense incurred as a result of a claim of breach of warranty; or (viii) attorney's fees.

The remedies of buyer set forth herein are exclusive and are in lieu of all other remedies. The liability of V.P.I., whether in contract, tort, under any warranty, or otherwise, shall not extend beyond its obligation as set forth herein. V.P.I. shall not be liable for cost of removal or installation nor shall V.P.I. be responsible for any direct, indirect, special or consequential damages of any nature. In no event shall V.P.I. be liable for any sum in excess of the price received for the goods for which liability is claimed.

There are no representations or warranties which have been authorized to the buyer of the Ventrac commercial equipment other than set forth in this warranty. Any and all statements or representations made by any seller of this equipment, including those set forth in any sales literature or made orally by any sales representative, are superseded by the terms of this warranty. Any affirmation of fact or promise made by V.P.I. or any of its representatives to the buyer which relates to the goods that are the subject to this warranty shall not be regarded as part of the basis of the bargain and shall not be deemed to create any express warranty that such goods shall conform to the affirmation or promise.

No employee, distributor, or representative is authorized to change the foregoing warranties in any way or grant any other warranty on behalf of V.P.I.

Some states do not allow limitations on how long an implied warranty lasts or allow the exclusion on limitation of incidental or consequential damages, so the above limitation or exclusion may not apply to you.

This warranty gives you specific legal rights, and you may also have other rights which vary from state to state.

This warranty applies to all Ventrac commercial equipment sold by Venture Products Inc.