



Operator's Manual

MW560 / MW720

Flail Mower





View all manuals



500 Venture Drive
Orrville Oh 44667
www.ventrac.com

Visit ventrac.com/manuals for the latest version of this operator's manual. A downloadable parts manual is also available.

To the Owner Contact Information and Product Identification

If you need to contact an authorized Ventrac dealer for information on servicing your product, always provide the product model and serial numbers.

Please fill in the following information for future reference. See the picture(s) below to find the location of the identification numbers. Record them in the spaces provided.

Date of Purchase: _____

Dealer: _____

Dealer Address: _____

Dealer Phone Number: _____

Dealer Fax Number: _____

Model # (A): _____ Serial # (B): _____ Affix Part/Serial Number label here.

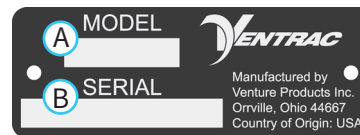

Venture Products Inc. reserves the right to make changes in design or specifications without obligation to make like changes on previously manufactured products.

TABLE OF CONTENTS

INTRODUCTION	PAGE 5
Product Description	5
Why Do I Need an Operator's Manual?	5
Using Your Manual.	6
Manual Glossary	6
SAFETY	PAGE 7
General Safety Procedures.	7
Training Required	7
Requirements for Personal Protective Equipment (PPE)	7
Operation Safety.	7
Keep Riders Off.	9
Operating On Slopes	9
Roadway Safety	10
Truck Or Trailer Transport	10
Maintenance	10
Fuel Safety	11
Hydraulic Safety	12
Safety Decals	14
OPERATIONAL CONTROLS	PAGE 16
Height Adjustment Handles	16
Primary SDLA Control Lever.	16
Secondary SDLA Control Lever	16
Weight Transfer	16
GENERAL OPERATION	PAGE 17
Daily Inspection	17
Attaching	17
Detaching	17
Checking for Rotor Vibration	17
Mowing and Operating Procedure	18
Transport of Attachment.	18
Cutting Height Adjustment	18
SERVICE	PAGE 19
Cleaning and General Maintenance	19
Deck Flip Up Procedure (Service Position)	19
Cutting Knife Inspection and Replacement	20
Belt Inspection	21
Attachment Drive Belt Replacement.	21
Rotor Drive Belt Replacement.	21
Rotor Drive Belt Tension Adjustment	22
Lubrication Locations.	22
Checking the Gearbox Oil Level.	24
Changing the Gearbox Oil	24
Storage	24
Maintenance Schedule	25
Maintenance Checklist	26

TABLE OF CONTENTS

SPECIFICATIONS	PAGE 27
Dimensions	27
Features	27
WARRANTY	PAGE 28

INTRODUCTION



Venture Products Inc. is pleased to provide you with your new Ventrac flail mower! We hope that Ventrac equipment will provide you with a ONE Tractor Solution.

Please visit our website, or contact your authorized Ventrac dealer for a complete list of items available for your new flail mower.

Accessories	Item Description	Part Number
	Hydraulic Deck Flip Up Kit	70.8224

Product Description

The MW series fine cut flail mowers are equipped with scoop knives to achieve a quality cut with a finished look on grassy material. The MW flail mower is available in two sizes. The MW560 has a 142 cm (56 inch) cutting width and the MW720 has a 183 cm (72 inch) cutting width.

The flail mower features a cutting height range from 25 mm (1 inch) to 101.5 mm (4 inches) in 6.4 mm (1/4 inch) increments, along with settings for 114.3 mm (4-1/2 inches) and 127 mm (5 inches). The cutting height is easily adjustable using the two height adjust handles. The flail mower also features side to side oscillation, front to back rotation, and a full length rear roller for even cutting and grass striping.

The deck can be tilted up to a near vertical position for cleaning and maintenance. An optional hydraulic deck flip up kit uses the power unit hydraulic system to flip the deck up to the vertical position.

Why Do I Need an Operator's Manual?

This manual has been created to help you gain the important knowledge of what is needed to safely operate, maintain, and service your machine. It is divided into sections for convenient reference of the appropriate section.

You must read and understand the operator's manual for each piece of Ventrac equipment you own. Reading the operator's manual will help you become familiar with each specific piece of equipment. Understanding the operator's manual will help you, as well as others, avoid personal injury and/or damage to the equipment. Keep this manual with the machine at all times. The manual should remain with the machine even if it is sold. If this manual becomes damaged or unreadable, it should be replaced immediately. Contact your local Ventrac dealer for a replacement.

When using a Ventrac attachment, be sure to read and follow the safety and operating instructions of both the power unit and the attachment being used to ensure the safest operation possible.

The information in this manual provides the operator with the safest procedures to operate the machine while getting the maximum use out of the unit. Failure to follow the safety precautions listed in this manual may result in personal injury and/or damage to the equipment.

INTRODUCTION

Using Your Manual

Throughout this manual, you will encounter special messages and symbols that identify potential safety concerns to help you as well as others avoid personal injury or damage to the equipment.

SYMBOL DEFINITIONS

ATTENTION

 This symbol identifies potential health and safety hazards. It marks safety precautions. Your safety and the safety of others is involved.

There are three signal words that describe the level of safety concern: Danger, Warning, and Caution. Safety should always be the #1 priority when working on or operating equipment. Accidents are more likely to occur when proper operating procedures are not followed or inexperienced operators are involved.

Note: Right-Hand and Left-Hand orientations may be referred to at different places throughout this manual. Right-Hand and Left-Hand is determined as if facing forward from the operator station.

SIGNAL WORD DEFINITIONS

DANGER

Indicates an imminently hazardous situation which, if not avoided, will result in death or serious injury. This signal word is limited to the most extreme cases.

WARNING

Indicates a potentially hazardous situation which, if not avoided, could result in death or serious injury.

CAUTION

Indicates a potentially hazardous situation which, if not avoided, may result in minor or moderate injury and/or property damage. It may also be used to alert against unsafe practices.

Manual Glossary

- Power Unit** A Ventrac tractor or other Ventrac engine powered device that may be operated by itself or with an attachment or accessory.
- Attachment** A piece of Ventrac equipment that requires a Power Unit for operation.
- Accessory** A device that attaches to a Power Unit or Attachment to extend its capabilities.
- Machine** Describes any “Attachment” or “Accessory” that is used in conjunction with a power unit.

SAFETY



General Safety Procedures for Ventrac Power Units, Attachments, & Accessories



Training Required

- The owner of this machine is solely responsible for properly training the operators.
- The owner/operator is solely responsible for the operation of this machine and for the prevention of accidents or injuries occurring to him/herself, other people, or property.
- Do not allow operation or service by children or untrained personnel. Local regulations may restrict the age of the operator.
- Before operating this machine, read the operator's manual and understand its contents.
- If the operator of the machine cannot understand this manual, then it is the responsibility of this machine's owner to fully explain the material within this manual to the operator.
- Learn and understand the use of all the controls.
- Know how to stop the power unit and the attachments quickly in the event of an emergency.

Requirements for Personal Protective Equipment (PPE)

- The owner is responsible for ensuring that all the operators use the proper PPE while operating the machine. Whenever you use the machine, use the following PPE:
- Certified eye protection and hearing protection.
- Closed toe, slip resistant footwear.
- Long pants or trousers.
- A dust mask for dusty conditions.

Operation Safety

- Inspect the machine before operation. Repair or replace any damaged, worn, or missing parts. Be sure the guards and shields are in proper working condition and are secured in place. Make any necessary adjustments before operating the machine.
- Some pictures in this manual may show shields or covers opened or removed in order to clearly illustrate the instructions. Under no circumstance should the machine be operated without these devices in place.
- Alterations or modifications to this machine can reduce safety and could cause damage to the machine. Do not alter the safety devices or operate with the shields or covers removed.
- Before each use, verify that all the controls function properly and inspect all the safety devices. Do not operate if the controls or safety devices are not in proper working condition.
- Check the parking brake function before operating. Repair or adjust the parking brake if necessary.
- Observe and follow all of the safety decals.
- All the controls are to be operated from the operator's station only.
- Always wear a seat belt if the machine has a roll cage/bar installed and in the upright position.
- Ensure the attachment or accessory is locked or fastened securely to the power unit before operating.

SAFETY



General Safety Procedures for Ventrac Power Units, Attachments, & Accessories



- Ensure that all bystanders are clear of the power unit and the attachment before operating. Stop the machine if someone enters your work area.
- Always be alert to what is happening around you, but do not lose focus on the task you are performing. Always look in the direction the machine is moving.
- Look behind and down before backing up to be sure of a clear path.
- If you hit an object, stop and inspect the machine. Make any necessary repairs before operating the machine again.
- Stop operation immediately at any sign of equipment failure. An unusual noise can be a warning of equipment failure or a sign that maintenance is required. Make any necessary repairs before operating the machine again.
- If equipped with a high/low range feature, never shift between high and low range while on a slope. Always move the machine to level ground and engage the parking brake before shifting range.
- Do not leave the machine unattended while it is running.
- Always park the machine on level ground.
- Always shut off the engine when connecting the attachment drive belt to the power unit.
- Never leave the operator's station without lowering the attachment to the ground, engaging the parking brake, shutting off the engine, and removing the ignition key. Make sure all moving parts have come to a complete stop before dismounting.
- Never leave the machine unattended without lowering the attachment to the ground, engaging the parking brake, shutting off the engine, and removing the ignition key.
- Only operate in well-lit conditions.
- Do not operate when there is a risk of lightning.
- Never direct the discharge of any attachment in the direction of people, buildings, animals, vehicles, or other objects of value.
- Never discharge material against a wall or obstruction. The material may ricochet back toward the operator.
- Use extra caution when approaching blind corners, shrubs, trees, or other objects that may obscure your vision.
- Do not run the engine in a building without adequate ventilation.
- Do not touch the engine or the muffler while the engine is running or immediately after stopping the engine. These areas may be hot enough to cause a burn.
- Do not change the engine governor settings or over-speed the engine. Operating the engine at excessive speeds may increase the hazard of personal injury.
- To reduce the hazard of fire, keep the battery compartment, engine, and muffler areas free of grass, leaves, excessive grease, and other flammable materials.
- Secure long hair and loose clothing. Do not wear jewelry.

SAFETY



General Safety Procedures for Ventrac Power Units, Attachments, & Accessories



- Clear the working area of objects that might be hit or thrown from the machine.
- Keep people and pets out of the working area.
- Know the work area well before operation. Do not operate where traction or stability is questionable.
- Reduce speed when you are operating over rough ground.
- Equipment can cause serious injury and/or death when improperly used. Before operating, know and understand the operation and safety of the power unit and the attachment being used.
- Do not operate the machine if you are not in good physical and mental health, if you will be distracted by personal devices, or if you are under the influence of any substance which might impair your decisions, dexterity, or judgment.
- Children are attracted to machine activity. Be aware of children and do not allow them in the work area. Turn off the machine if a child enters the work area.

Keep Riders Off

- Only allow the operator on the power unit. Keep riders off.
- Never allow riders on any attachment or accessory.

Operating On Slopes

- Slopes can cause loss-of-control and tip-over accidents, which can result in severe injury or death. Be familiar with the emergency parking brake, along with the power unit controls and their functions.
- If the power unit is equipped with a fold down roll bar, it must be locked in the upright position when operating on any slope.
- Use low range (if equipped) when operating on slopes greater than 15 degrees.
- Do not stop or start suddenly when operating on slopes.
- Never shift between high and low range while on a slope. Always move the power unit to level ground and engage the parking brake before shifting range or placing the power unit in neutral.
- Variables such as wet surfaces and loose ground will reduce the degree of safety. Do not drive where the machine could lose traction or tip over.
- Keep alert for hidden hazards in the terrain.
- Stay away from drop-offs, ditches, and embankments.
- Sharp turns should be avoided when operating on slopes.
- Pulling loads on hills decreases safety. It is the responsibility of the owner/operator to determine loads that can safely be controlled on slopes.
- Transport the machine with the attachment lowered or close to the ground to improve stability.
- While operating on slopes, drive in an up and down direction whenever possible. If turning is necessary

SAFETY



General Safety Procedures for Ventrac Power Units, Attachments, & Accessories



while driving across slopes, reduce your speed and turn slowly in the downhill direction.

- Ensure a sufficient supply of fuel for continuous operation. A minimum of one-half tank of fuel is recommended.

Roadway Safety

- Operate with safety lights when operating on or near roadways.
- Obey all state and local laws concerning operation on roadways.
- Slow down and be careful of traffic when operating near or crossing roadways. Stop before crossing roads or sidewalks. Use care when approaching areas or objects that may obscure vision.
- If there is any doubt of safety conditions, discontinue the machine operation until a time when the operation can be performed safely.
- When operating near or on roadways, have a Slow Moving Vehicle Emblem clearly displayed.

Truck Or Trailer Transport

- Use care when loading or unloading the machine into a truck or trailer.
- Use full width ramps for loading the machine into a truck or trailer.
- The parking brake is not sufficient to lock the machine during transport. Always secure the power unit and/or attachment to the transporting vehicle securely using straps, chains, cables, or ropes. Both the front and rear straps should be directed down and outward from the machine.
- Shut off the fuel supply to the power unit during transport on a truck or trailer.
- If equipped, turn the battery disconnect switch to the Off position to shut off electrical power.

Maintenance

- Keep the safety decals legible. Remove all grease, dirt, and debris from the safety decals and instructional labels.
- If any decals are faded, illegible, or missing, contact your dealer promptly for replacements.
- When new components are installed, be sure that the current safety decals are affixed to the replacement components.
- If any component requires replacement, use only original Ventrac replacement parts.
- Always turn the battery disconnect to the Off position or disconnect the battery before performing any repairs. Disconnect the negative terminal first and the positive terminal last. Reconnect the positive terminal first and the negative terminal last.
- Keep all bolts, nuts, screws, and other fasteners properly tightened.
- Always lower the attachment to the ground, engage the parking brake, shut off the engine, and remove the ignition key. Make sure all moving parts have come to a complete stop before cleaning, inspecting, adjusting, or repairing.
- If the power unit, attachment, or accessory requires repairs or adjustments not instructed in the operator's

SAFETY



General Safety Procedures for Ventrac Power Units, Attachments, & Accessories



- manual, the power unit, attachment, or accessory must be taken to an authorized Ventrac dealer for service.
- Never perform maintenance on the power unit and/or attachment if someone is in the operator's station.
- Always use protective glasses when handling the battery.
- Check the fuel lines for tightness and wear on a regular basis. Tighten or repair them as needed.
- To reduce the hazard of fire, keep the battery compartment, engine, and muffler areas free of grass, leaves, and excess grease.
- Do not touch the engine, the muffler, or other exhaust components while the engine is running or immediately after stopping the engine. These areas may be hot enough to cause a burn.
- Allow the engine to cool before storing and do not store near an open flame.
- Do not change the engine governor settings or over-speed the engine. Operating engine at excessive speeds may increase the hazard of personal injury.
- Springs may contain stored energy. Use caution when disengaging or removing springs and/or spring loaded components.
- An obstruction or blockage in a drive system or moving/rotating parts may cause a buildup of stored energy. When the obstruction or blockage is removed, the drive system or moving/rotating parts may move suddenly. Do not attempt to remove an obstruction or blockage with your hands. Keep your hands, feet, and clothing away from all power-driven parts.

Fuel Safety

- To avoid personal injury or property damage, use extreme care in handling gasoline. Gasoline is extremely flammable and the vapors are explosive.
- Do not refuel the machine while smoking or at a location near flames or sparks.
- Always refuel the machine outdoors.
- Do not store the machine or fuel container indoors where the fumes or fuel can reach an open flame, spark, or pilot light.
- Only store fuel in an approved container. Keep out of the reach of children.
- Never fill containers inside a vehicle or on a truck or trailer bed with a plastic liner. Always place the containers on the ground away from your vehicle before filling.
- Remove the machine from the truck or trailer and refuel it on the ground. If this is not possible, refuel the machine using a portable container, rather than from a fuel dispenser nozzle.
- Never remove the fuel cap or add fuel with the engine running. Allow the engine to cool before refueling.
- Never remove the fuel cap while on a slope. Only remove the fuel cap when parked on a level surface.
- Replace the fuel tank cap and the container cap securely.
- Do not overfill the fuel tank. Only fill to the bottom of the fuel neck, do not fill the fuel neck full. Overfilling of the fuel tank could result in engine flooding, fuel leakage from the tank, and/or damage to the emissions

SAFETY



General Safety Procedures for Ventrac Power Units, Attachments, & Accessories



control system.

- If fuel is spilled, do not attempt to start the engine. Move the power unit away from the fuel spill and avoid creating any source of ignition until the fuel vapors have dissipated.
- If the fuel tank must be drained, it should be drained outdoors into an approved container.
- Check the fuel lines for tightness and wear on a regular basis. Tighten or repair them as needed.
- The fuel system is equipped with a shut-off valve. Shut off the fuel when transporting the machine to and from the job, when parking the machine indoors, or when servicing the fuel system.

Hydraulic Safety

- Make sure the hydraulic connections are tight and all hydraulic hoses and tubes are in good condition. Repair any leaks and replace any damaged or deteriorated hoses or tubes before starting the machine.
- Hydraulic leaks can occur under high pressure. Hydraulic leaks require special care and attention.
- Use a piece of cardboard and a magnifying glass to locate suspected hydraulic leaks.
- Keep your body and hands away from pinhole leaks or nozzles that eject high pressure hydraulic fluid. Hydraulic fluid escaping under high pressure can penetrate the skin causing serious injury, leading to severe complications and/or secondary infections if left untreated. If hydraulic fluid is injected into the skin, seek immediate medical attention no matter how minor the injury appears.
- The hydraulic system may contain stored energy. Before performing maintenance or repairs on the hydraulic system, remove any attachments, engage the parking brake, disengage the weight transfer system (if equipped), shut off the engine, and remove the ignition key. To relieve pressure on the auxiliary hydraulic system, shut off the power unit engine and move the hydraulic control lever left and right before disconnecting the auxiliary hydraulic quick couplers.

SAFETY



MW560 / MW720 Safety Procedures



- **Blade Hazard:** Contact with the mower blades or other moving parts may cause personal injury. Keep your hands and feet away.
- When removing a cutting unit blockage, residual power in the flail rotor system could cause injury through sudden movement of the flail rotor when the blockage is released. Never attempt to rotate the flail rotor or clear a blockage using your hands or feet.
- **Thrown Object Hazard:** Do not direct the mower discharge toward people, animals, or buildings. Never operate with the deflector(s) removed.
- Always shut off the PTO to stop the mower blades whenever you are not mowing, especially when crossing loose terrain such as gravel.
- Never raise the mower deck with the blades running.

SAFETY

Safety Decals

The following safety decals must be maintained on your attachment.

Keep all safety decals legible. Remove all grease, dirt, and debris from safety decals and instructional labels. If any decals are faded, illegible, or missing, contact your dealer promptly for replacements.

When new components are installed, be sure that current safety decals are affixed to the replacement components.

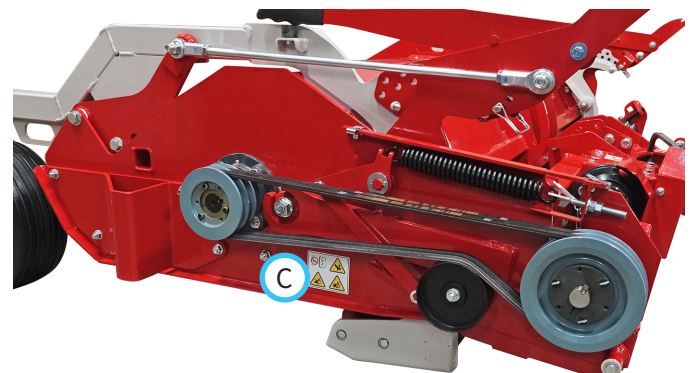
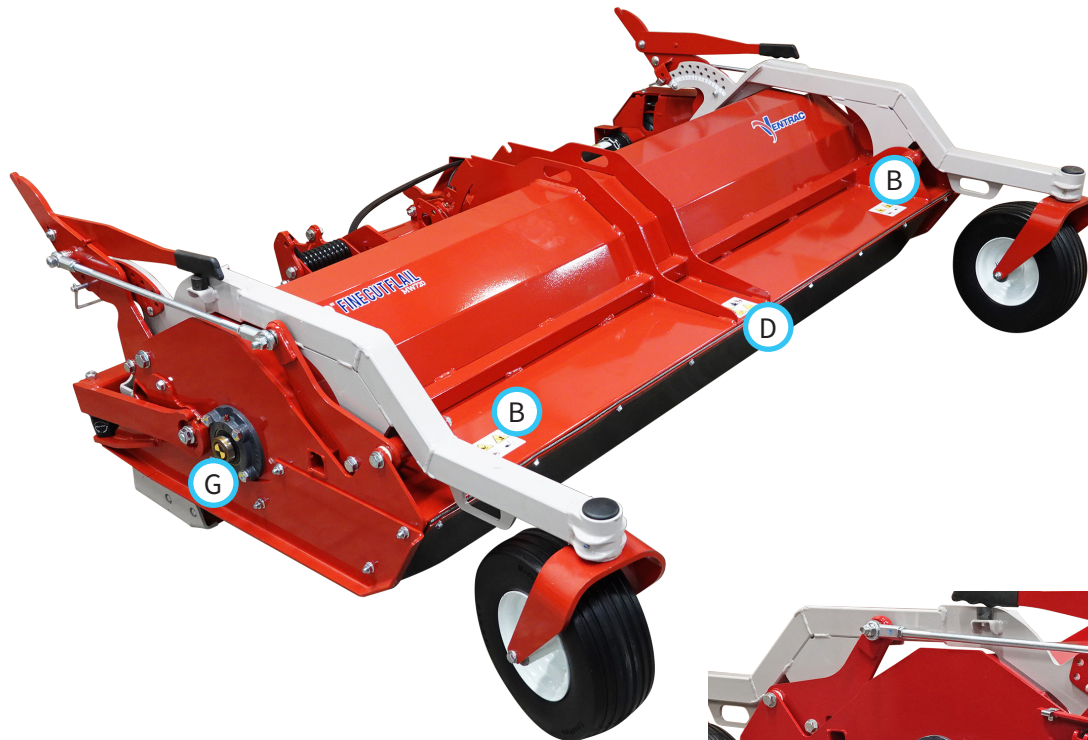
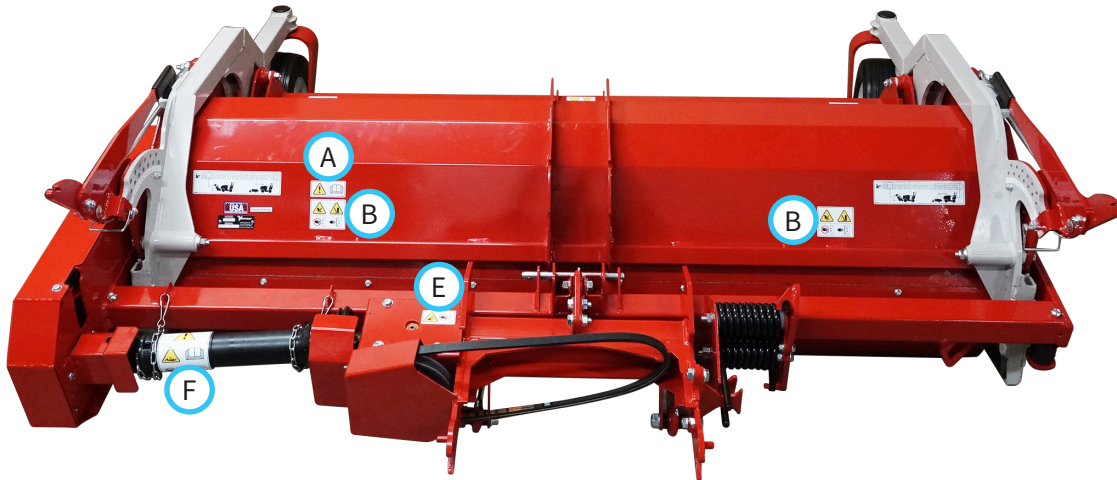

SAFETY



Warning - Read Operator's Manual

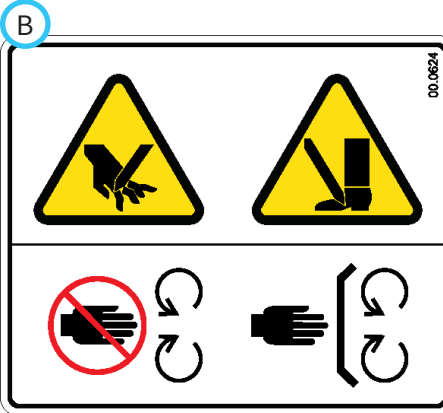

Cutting/dismemberment hazard of the hand or foot.
Stay away from moving parts.
Keep all guards and shields in place.

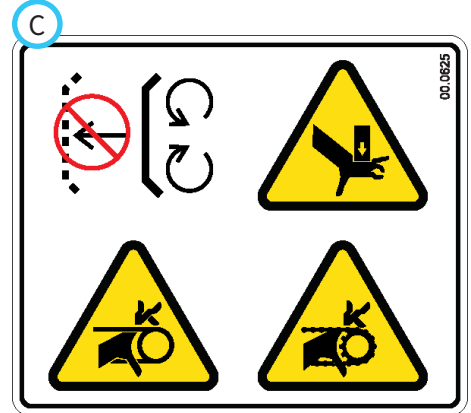

Shield missing - Do not operate.
Pinching/crushing hazard.
Fingers or hand entanglement.

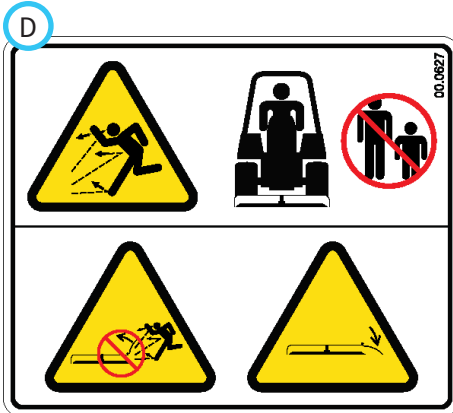

Thrown object hazard.
Keep bystanders away from the machine.
Do not operate with the deflector belting removed.

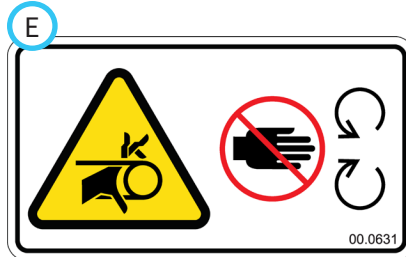

Fingers or hand entanglement.
Stay away from moving parts.

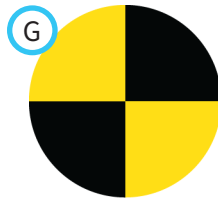

Rotor shaft rotation indicator.
Stay away from moving parts.



Danger - Rotating drive shaft.
Stay away from moving parts.
Do not operate with the drive shaft guards removed.

Decal	Description	Part Number	Quantity
A	Read Operator's Manual	00.0619	1
B	Cutting Hazard - Hands and Feet	00.0624	4
C	Shield Missing	00.0625	1
D	Thrown Object Hazard	00.0627	1
E	Finger/Hand Entanglement	00.0631	1
F	Shaft Entanglement Hazard	00.0661	1
G	Shaft Rotation Indicator	00.0663	1

OPERATIONAL CONTROLS

Height Adjustment Handles

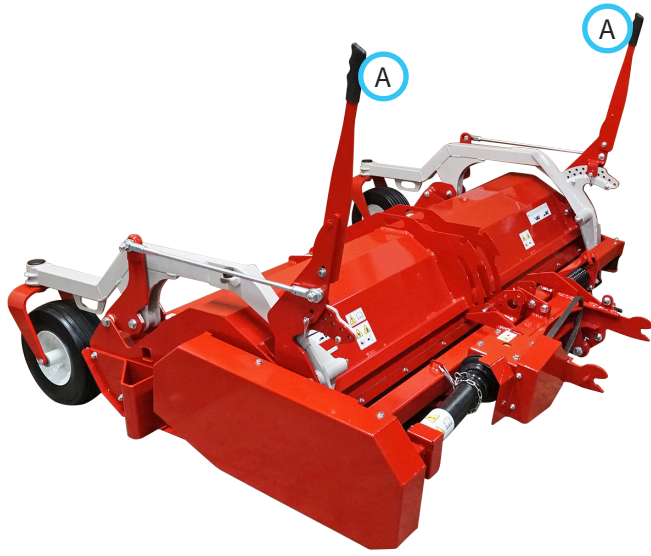

The height adjustment handles (A) are used to raise and lower the mower deck to the desired cutting height. The right and left adjustment handles must both be set to the same height position. The cutting height position decals list the adjustment handle positions and the corresponding cutting heights.

Primary SDLA Control Lever

Pull the power unit's primary SDLA control lever* to the left to raise the power unit front hitch and the flail mower. Push the lever to the right to lower the power unit front hitch and the flail mower. When mowing, place the control lever in the float position by pushing the lever to the right until the float detent locks the lever in place.

Secondary SDLA Control Lever

The power unit's secondary SDLA control lever* controls the optional hydraulic deck flip up kit. Pull the lever to the left to flip the deck up to the service position. Push the lever to the right to lower the deck back down to the operating position.

Weight Transfer

Terrain and ground conditions may affect the appropriate setting for the power unit's weight transfer system*. In most cases, the weight transfer system should be set from three-fourths to full capacity.

*Refer to power unit operator's manual for operation of power unit controls.

GENERAL OPERATION

Daily Inspection

WARNING

Always engage the parking brake, shut off the power unit engine, remove the ignition key, and ensure that all moving parts have come to a complete stop before inspecting the components, or attempting any repair or adjustment.

1. Park the machine on a level surface, with the engine shut off and all fluids cold.
2. Perform a visual inspection of both the power unit and the attachment. Look for loose or missing hardware, damaged components, or signs of wear.
3. If equipped, inspect the hydraulic hoses and the hydraulic fittings to ensure tight, leak free connections.
4. Inspect the belts for damage or excessive wear. Refer to the Belt Inspection section of this manual.
5. Inspect the cutting knives and mounting bolts. The blades should be sharp and securely fastened. Service as required.
6. Check for rotor vibration.

Attaching

1. Check to ensure both mower deck height adjustment handles are set to position number 15.
2. Drive the power unit slowly forward into the hitch arms of the attachment. Align the lift arms of the power unit with the attachment hitch arms by raising or lowering the front hitch and complete the engagement.
3. Once completely engaged, close the front hitch locking lever.*
4. Engage the parking brake* and shut off the engine.
5. Place the attachment belt onto the PTO drive pulley on the power unit. Ensure the belt is properly seated in each pulley.
6. Engage the PTO tension spring.
7. If equipped, wipe the hose ends clean, and connect to the power unit's hydraulic quick couplers. If equipped, connect the hoses and the quick couplers so the colored indicators are paired together (red to red, etc.).

Detaching

1. Set both of the mower deck height adjustment handles to position number 15.
2. Park the power unit on a level surface and engage the parking brake.*
3. Lower the attachment to the ground.

4. Shut off the power unit engine.
5. Disengage the PTO tension spring.
6. Remove the attachment belt from the PTO drive pulley of the power unit.
7. If equipped, disconnect the hydraulic quick couplers from the power unit.
8. Disengage the front hitch locking lever.*
9. Restart the power unit and slowly back away from the attachment. A side to side movement of the steering wheel may aid in disengagement.

Checking for Rotor Vibration

Before each use, check for any unusual vibration of the rotor.

1. Park the power unit and flail mower on a level, open area away from bystanders.
2. Lower the mower to the ground and engage the parking brake.
3. With the power unit engine running between 2,000 and 3,000 RPM, engage the PTO switch, then adjust the throttle to full engine speed.
4. If the rotor vibration is unusual, shut off the engine, remove the ignition key, and wait for all moving parts to stop.
5. Check the rotor for debris that prevents the rotor and blades from operating correctly. Remove any blockages.
6. Check for a damaged rotor or worn rotor bearings.
7. Check for missing, damaged, unbalanced, or excessively worn cutting knives. Refer to the Cutting Knife Inspection and Replacement section.

ATTENTION

If you cannot correct the cause of unusual rotor vibration, contact your authorized Ventrac dealer.

*Refer to power unit operator's manual for operation of power unit controls.

GENERAL OPERATION

Mowing and Operating Procedure

ATTENTION

If an object is struck or the mower develops an unusual vibration during operation, shut off the PTO immediately. Refer to the Checking Rotor for Vibration section and make all necessary repairs before resuming operation.

If a cutting knife is missing or significantly damaged, STOP! Cease operation until the cutting knife is replaced. Refer to the Cutting Knife Inspection and Replacement section for instructions on replacement and maintaining rotor balance.

Before operation, perform the daily inspection and confirm the cutting height and the power unit weight transfer system are set properly.

Inspect the mowing area and remove rocks, sticks, and any other objects that could be thrown from the machine or become entangled in blades or rotor.

Lower the mower deck to the ground and place the power unit's SDLA lever in the float position by pushing it to the right until the detent engages. The lever will stay in this position until intentionally removed.

With the power unit engine running between 2,000 and 3,000 RPM, engage the PTO switch, then adjust the throttle to the desired engine RPM.

Begin forward motion in the desired mowing path. Avoid obstacles and remove debris as necessary. To maintain cut quality, adjust your ground speed for the conditions. Decrease the ground speed as the load on the flail mower increases. Increase the ground speed when the load on the flail mower decreases. When the edge of the mowing area is reached, turn around and align the mower for the next pass.

Mowing in a back and forth pattern, where each mowing pass is made in the opposite direction of the pass next to it, will create a stripe pattern in the grass. The full length rear roller rolls the grass in the direction of travel to further enhance the stripe effect.

When mowing is complete, slow the engine speed to 2,500 RPM or lower before disengaging the PTO switch.

Transport of Attachment

Transport the attachment with the power unit front hitch and attachment fully raised to reduce wear of the equipment. Travel slowly when transporting over undulating and rough surfaces to maintain control of the power unit and to reduce the shock to the power unit and the attachment. Always disengage the power unit PTO before transporting the attachment.

Cutting Height Adjustment

1. Lift the left height adjustment handle (A) upward and engage the pin into the notch in the rear carrier rocker.

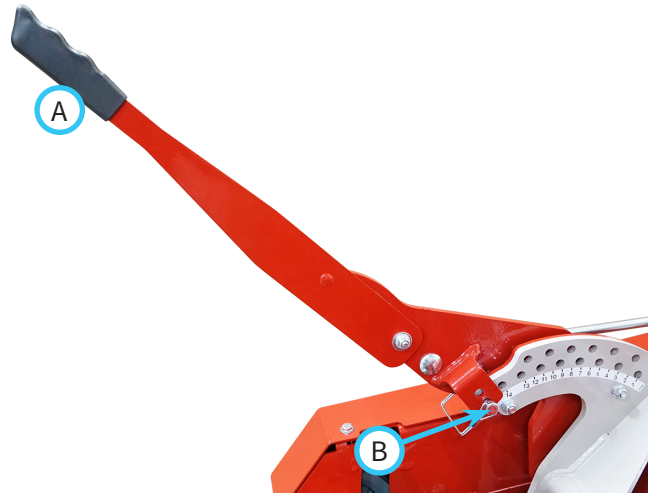

2. Pull back slightly on the handle to relieve pressure on the locking pin and remove the locking pin (B) from the rear carrier rocker.
3. Raise or lower the height adjustment handle to the desired cutting height setting and reinstall the locking pin.
4. Disengage the pin on the height adjustment handle from the notch in the rear carrier rocker and rotate the height adjustment handle down to rest on the handle stop.
5. Repeat for the right height adjustment handle, making sure to set in the same cutting height position as the left height adjustment handle.

SERVICE

⚠ WARNING

Always engage the parking brake, shut off the power unit engine, remove the ignition key, and ensure that all moving parts have come to a complete stop before inspecting the components, or attempting any repair or adjustment.

ATTENTION

If any component requires replacement, use only original Ventrac replacement parts.

Cleaning and General Maintenance

For best results, and to maintain the finish of the mower, clean or wash the mower to remove accumulated clippings, leaves, and dirt when the job is finished. Refer to the Deck Flip Up Procedure to access the underside of the deck. If washing the mower, do not spray directly into bearings or seals.

Deck Flip Up Procedure (Service Position)

Manual Flip Up Procedure

1. Park the power unit and mower on a smooth, level surface.
2. Engage the parking brake, shut off the engine, and remove the ignition key.
3. Place the left and right height adjustment handles into position number one.
4. Remove the pin (A) from the cross frame brackets.

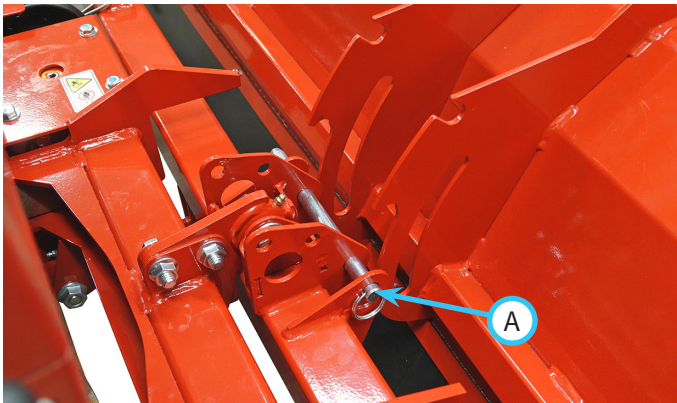

5. Start the power unit's engine and raise the power unit front hitch to its highest position.

6. Shut off the engine and remove the ignition key.
7. Lift the front of the deck up until the slots in the center deck braces align with the holes in the cross frame brackets. Reinstall the pin to lock the deck in the service position.

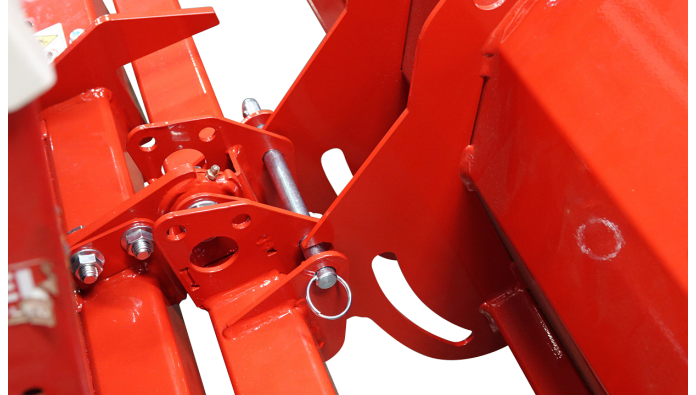

8. To return the deck to the operating position, remove the pin from the cross frame brackets and lower the deck to the operating position. NOTE: if the front hitch lowers due to hydraulic drift, it may be necessary to start the power unit's engine and raise the front hitch before removing the pin.
9. Lower the mower deck to the ground.
10. Reinstall the pin in cross frame brackets.

SERVICE

Optional Hydraulic Flip Up Procedure

1. Park the power unit and mower on a smooth, level surface.
2. Engage the parking brake, shut off the engine, and remove the ignition key.
3. Place the left and right height adjustment handles into position number one.
4. Remove the pin (A) from the cross frame brackets.

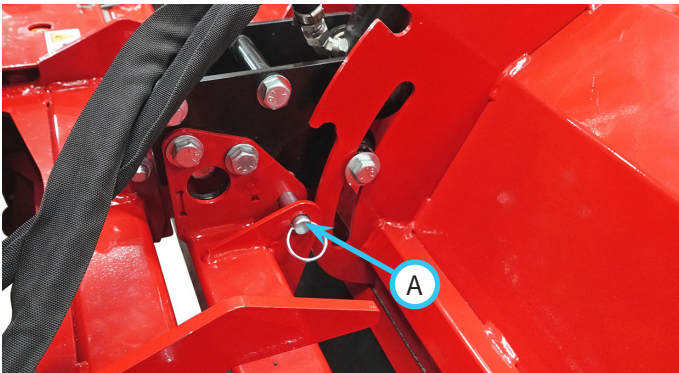

5. Start the power unit's engine and raise the power unit front hitch to its highest position.
6. Pull the secondary SDLA lever to the left and hold to flip the deck up. Align the slots in the center deck braces with the holes in the cross frame brackets and reinstall the pin to lock the deck in the service position.

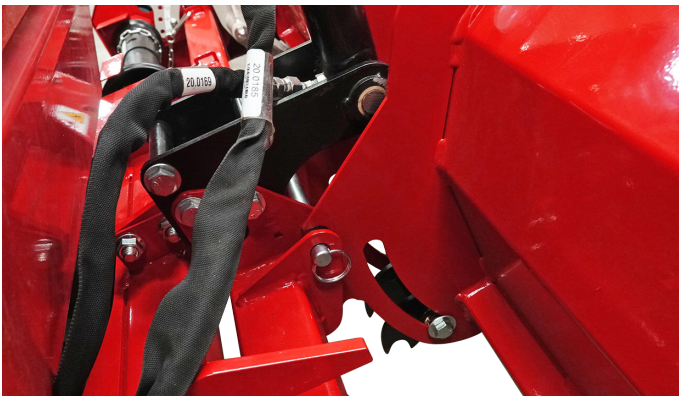

7. Shut off the power unit's engine and remove the ignition key.
8. To return the deck to the operating position, remove the pin from the cross frame brackets, return to the operator's seat, start the engine, and lower the deck to the operating position by pushing the secondary SDLA lever to the right. NOTE: if the front hitch lowers due to hydraulic drift, it may be necessary to start the power unit's engine and raise the front hitch before removing the pin.
9. Lower the mower deck to the ground.
10. Reinstall the pin in cross frame brackets.

Cutting Knife Inspection and Replacement

CAUTION

Wear heavy gloves and use caution when inspecting or servicing the knives.

1. Flip the deck up to the service position.
2. Inspect the knives for damage or excessive wear. Pay close attention to the cutting edge, the fasteners, and the mounting hole in the knife.

ATTENTION

To maintain the rotor balance when replacing a knife (A), you must also replace a knife (B) on the opposite side of the rotor. Replace the closest knife on a 180 degree plane from the knife that needs replacement.

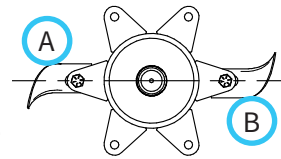

When replacing a knife, you should also replace the mounting hardware.

3. Note the side from which the mounting bolt is installed and remove the knife mounting hardware. Discard both the knife and the mounting hardware.
4. Insert the new knife (A) and spacers (B) between the mounting tabs and fasten with a new bolt (C) and nut (D). Install the bolt from the same direction as the original bolt. Tighten only until snug. The knife must rotate freely.

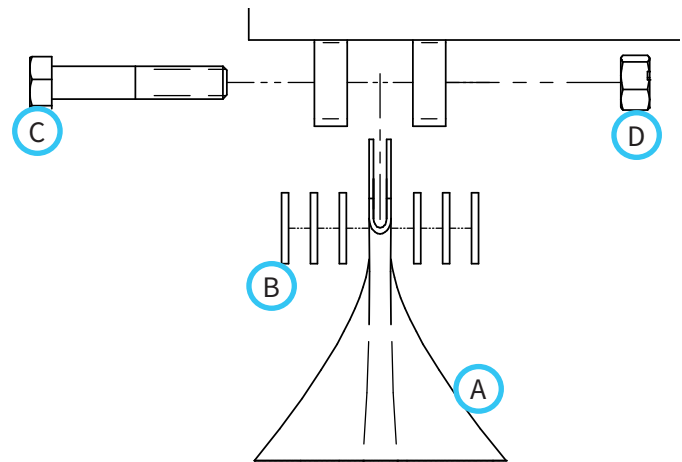

SERVICE

Belt Inspection

Inspecting the drive belts of the attachment can prevent sudden belt failure by finding problems before they cause a belt to break.

Typical wear on a drive belt may result in the conditions shown in the diagram. If any of these conditions

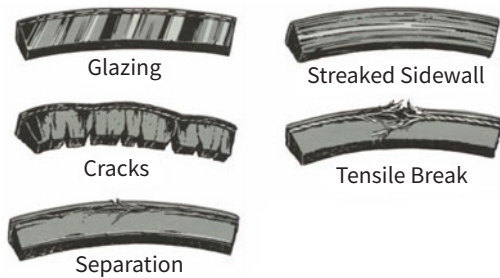

occur, the drive belt will require replacement.

Attachment Drive Belt Replacement

1. Detach the mower from the power unit.
2. Remove the drive pulley shield (A).

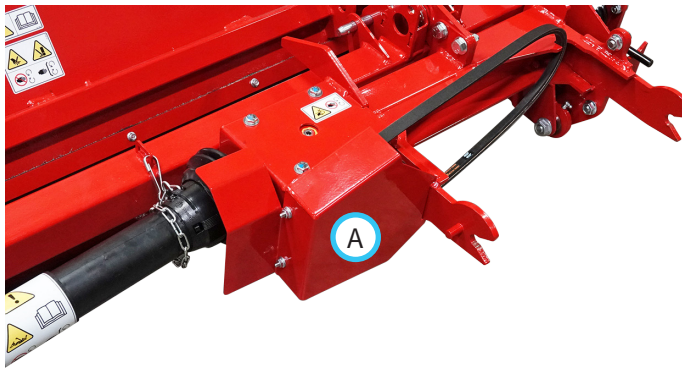

3. Remove the old attachment drive belt and install the new drive belt onto the pulley.
4. Reinstall the drive pulley shield. Torque the nuts to 11 Nm (100 in-lbs).

Rotor Drive Belt Replacement

1. Remove the rotor drive cover (A).

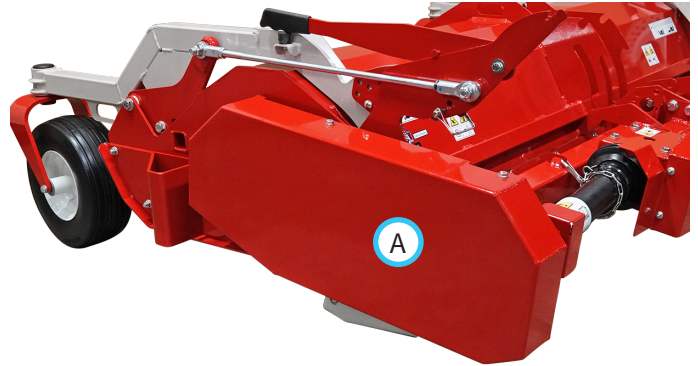

2. Release the belt tension by loosening the nuts (B, C) on the spring tensioner rod (D).

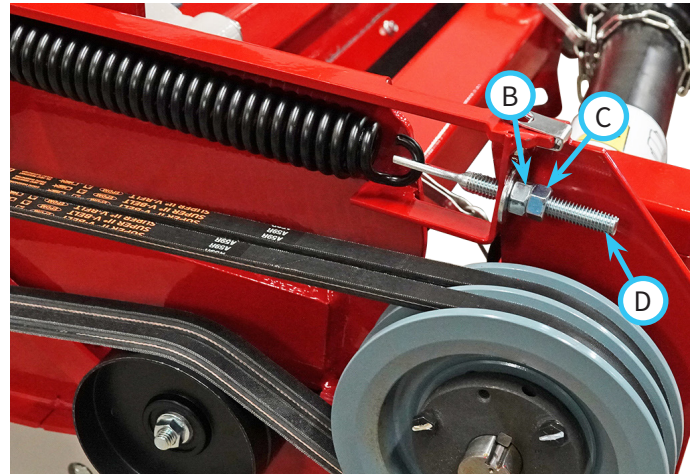

3. Remove the old rotor drive belts and install new drive belts onto the pulleys.
4. Tighten the adjustment nut (B) on the spring tensioner rod until there is approximately .8 - 1.6 mm (1/32 - 1/16 inch) gap between the spring coils.
5. Tighten the jam nut (C) against the adjustment nut to lock the spring tensioner rod in place.
6. Reinstall the rotor drive cover. Torque the bolts to 24 Nm (210 in-lbs).

SERVICE

Rotor Drive Belt Tension Adjustment

If the belt slips during normal operation, the belt tension will need to be adjusted.

1. Remove the rotor drive cover (A).

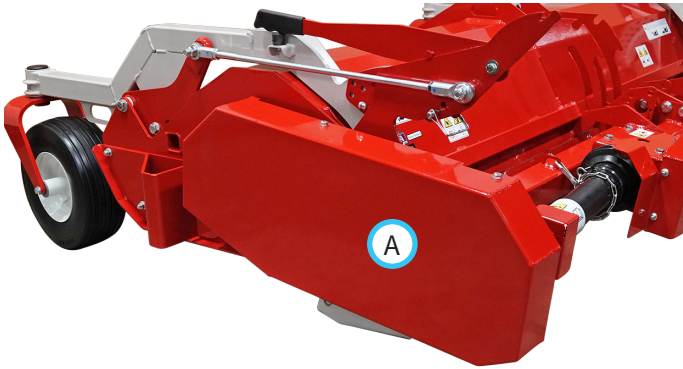

2. Loosen the jam nut (C) and tighten the adjustment nut (B) until there is approximately .8 - 1.6 mm (1/32 - 1/16 inch) gap between the spring coils.

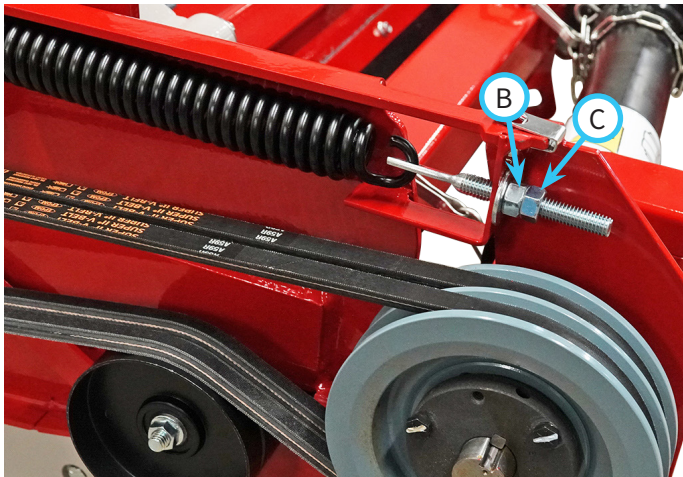

3. Tighten the jam nut against the adjustment nut to lock the spring tension rod in place.
4. Reinstall the rotor drive cover. Torque the bolts to 24 Nm (210 in-lbs).

Lubrication Locations

Lubrication is required at the following locations using a lithium complex NLGI #2 grease.

Wipe the grease fittings clean before applying grease to the grease fittings.

Refer to the maintenance schedule for service intervals and the amount of grease.

Detach the flail mower from the power unit and remove the rotor drive cover.

Set the height adjustment handles to position # 1 or 2. Grease the rear carrier rockers.

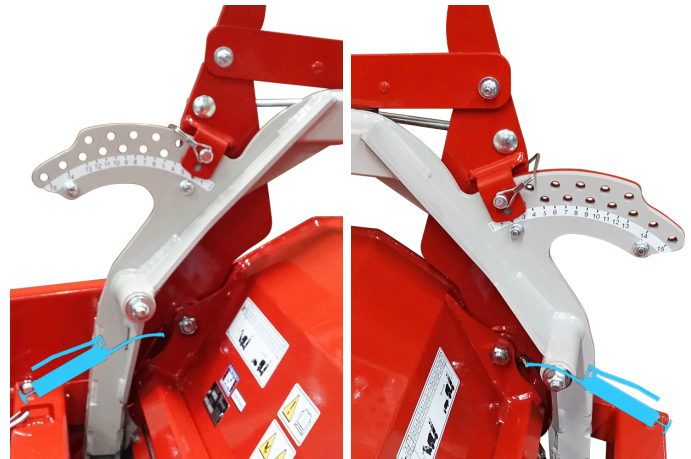

Set the height adjustment handles to position # 15. Grease the wheel axles and the wheel caster pivots.



Grease the rotor bearings and the cross pivot frame swivels on both sides of the deck.

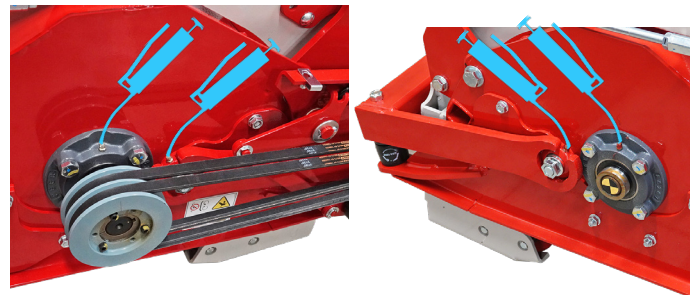

SERVICE

Grease the jack shaft bearings.

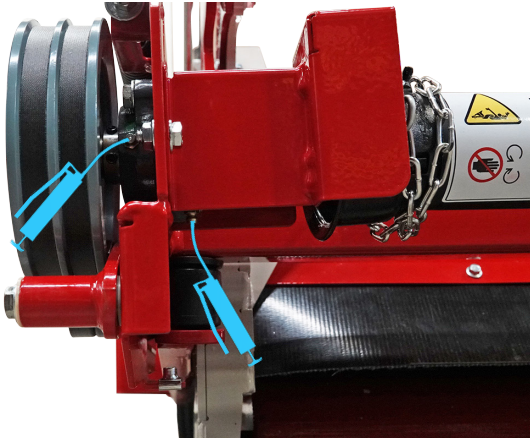

Grease the drive shaft cover.

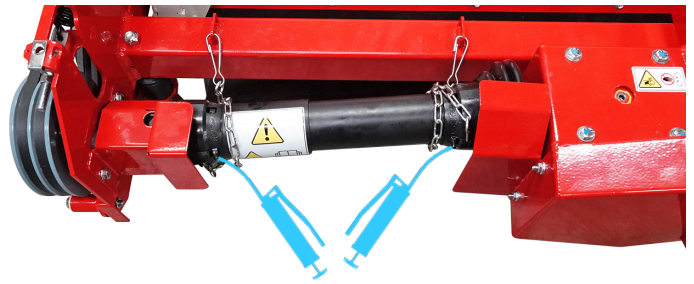

Grease the drive shaft universal joints.

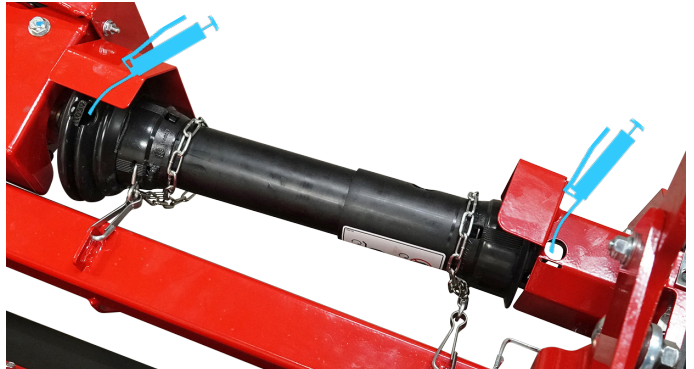

Grease the upper hitch swivel link.

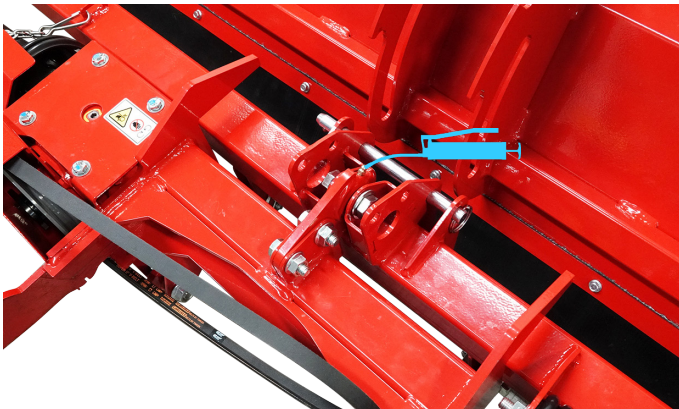

Rotate the drive shaft covers until the access holes align with the grease fitting on the drive shaft slide.

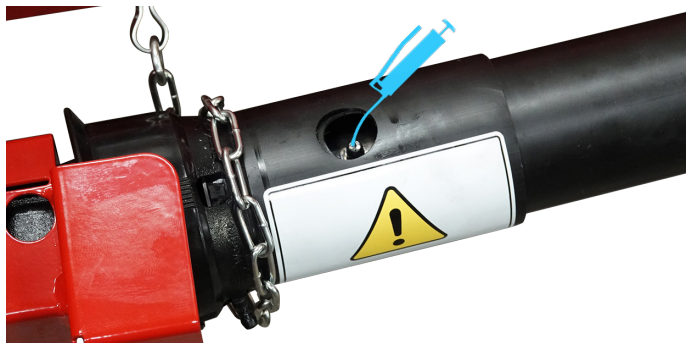

Grease the two lower swivel links (4 places).

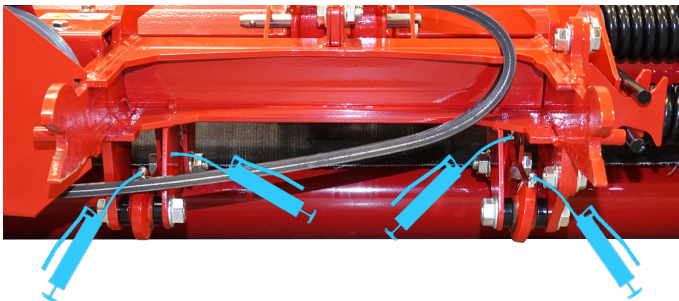

Reinstall the rotor drive cover.

Attach the flail mower to the power unit and flip the deck up to the service position.

Grease the right rear roller bearing.



Grease the left rear roller bearing.

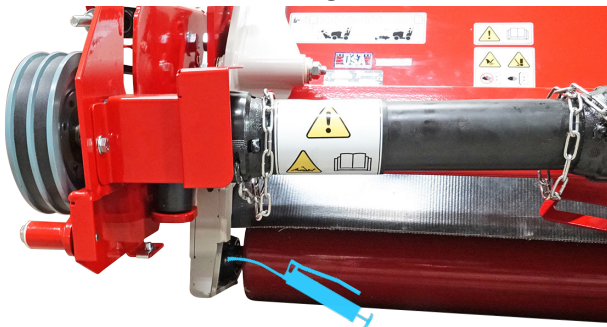

SERVICE

Checking the Gearbox Oil Level

1. Park the mower deck on a level surface.
2. Clean the top of the gearbox and remove the plug (A) from the top port.

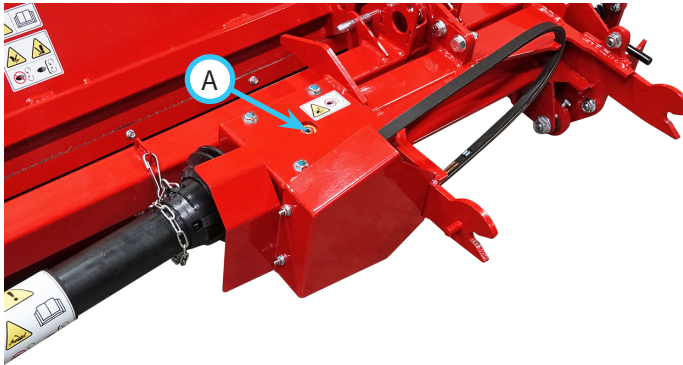

3. Check the oil level in the gearbox. The oil level should be maintained at approximately half full. If the oil level is low, add 75W-140 synthetic gear oil until the proper level is reached.
4. Reinstall the plug into the top port of the gearbox.

Changing the Gearbox Oil

1. Park the mower deck on a level surface.
2. Clean the top and the bottom of the gearbox.
3. Remove the plug (A) from the top port of the gearbox.

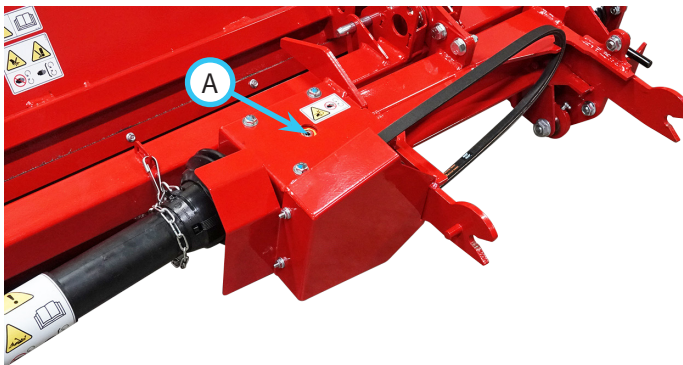

4. Place a drain pan underneath the gearbox.
5. Remove the plug from the bottom port of the gearbox and allow the gear oil to drain.
6. Reinstall the plug into the bottom port of the gearbox.
7. Add 75W-140 synthetic gear oil until the proper level is reached.
8. Reinstall the plug into the top port of the gearbox.

Storage

Preparing the Attachment for Storage

1. Clean the attachment to remove accumulated clippings, leaves, and dirt.
2. Inspect for loose or missing hardware, damaged components, or signs of wear. Repair or replace any damaged or worn components.
3. Inspect the drive belts and replace if damaged or worn.
4. Inspect the cutting knives and replace if damaged or worn.
5. Inspect the safety decals. Replace any decals that are faded, illegible, or missing.
6. Apply grease to all grease points and wipe off any excess grease.
7. Check the gearbox oil level.
8. If the mower is equipped with a hydraulic flip up kit, inspect the hydraulic hoses and fittings for damage or wear. Connections must be tight and leak free. Replace damaged or worn components.
9. Inspect the painted components for chips, scratches, or rust. Clean and touch up the surfaces as needed.

Removing the Attachment from Storage

1. Clean the attachment to remove any accumulated dust or debris.
2. Inspect the attachment as instructed in the Daily Inspection section of this manual.
3. Test the attachment to ensure that all the components are working properly.

SERVICE

Maintenance Schedule

Maintenance Schedule	# of locations	# of pumps	As Needed	Daily	At 50 hours	At 100 hours	At 150 hours	At 200 hours	At 250 hours	At 300 hours	At 350 hours	At 400 hours	At 450 hours	At 500 hours	At 550 hours	At 600 hours	At 650 hours	At 700 hours	At 750 hours	At 800 hours	At 850 hours	At 900 hours	At 950 hours	At 1,000 hours	Yearly	
Grease and Lubrication: See Lubrication Section																										
Rear Carrier Rocker	2	^			✓	✓	✓	✓	✓	✓	✓	✓	✓	✓	✓	✓	✓	✓	✓	✓	✓	✓	✓	✓	✓	
Wheel Swivel Bearing	2	1			✓	✓	✓	✓	✓	✓	✓	✓	✓	✓	✓	✓	✓	✓	✓	✓	✓	✓	✓	✓	✓	
Wheel Axle Bearing	2	^	**		✓	✓	✓	✓	✓	✓	✓	✓	✓	✓	✓	✓	✓	✓	✓	✓	✓	✓	✓	✓	✓	
Rotor Bearing	2	1			✓	✓	✓	✓	✓	✓	✓	✓	✓	✓	✓	✓	✓	✓	✓	✓	✓	✓	✓	✓	✓	
Cross Pivot Frame	2	^			✓	✓	✓	✓	✓	✓	✓	✓	✓	✓	✓	✓	✓	✓	✓	✓	✓	✓	✓	✓	✓	
Rear Roller Bearing	2	1			✓	✓	✓	✓	✓	✓	✓	✓	✓	✓	✓	✓	✓	✓	✓	✓	✓	✓	✓	✓	✓	
Jack Shaft Bearing	2	1			✓	✓	✓	✓	✓	✓	✓	✓	✓	✓	✓	✓	✓	✓	✓	✓	✓	✓	✓	✓	✓	
Drive Shaft	5	1			✓	✓	✓	✓	✓	✓	✓	✓	✓	✓	✓	✓	✓	✓	✓	✓	✓	✓	✓	✓	✓	
Upper Hitch Swivel Link	1	^			✓	✓	✓	✓	✓	✓	✓	✓	✓	✓	✓	✓	✓	✓	✓	✓	✓	✓	✓	✓	✓	
Lower Swivel Link	4	^			✓	✓	✓	✓	✓	✓	✓	✓	✓	✓	✓	✓	✓	✓	✓	✓	✓	✓	✓	✓	✓	
Check the Gearbox Oil Level						✓		✓		✓		✓		✓		✓		✓		✓		✓		✓		
Change the Gearbox Oil. Replace with 75W-140 synthetic gear oil					✓									✓											✓	
Inspection																										
Inspect for Loose, Missing, or Worn Components				✓																						
Inspect the Belts and Pulleys				✓																						
Inspect the Blades and the Blade Mounting Bolts				✓																						
Inspect the Safety Decals				✓																						
Inspect the hydraulic hoses and fittings (if equipped)																										
^Grease until fresh grease is visible.																										
**Operation in severe conditions may require more frequent service intervals.																										

SERVICE

Maintenance Checklist

Maintenance Schedule	# of locations	# of pumps	As Needed	Daily	At 50 hours	At 100 hours	At 150 hours	At 200 hours	At 250 hours	At 300 hours	At 350 hours	At 400 hours	At 450 hours	At 500 hours	At 550 hours	At 600 hours	At 650 hours	At 700 hours	At 750 hours	At 800 hours	At 850 hours	At 900 hours	At 950 hours	At 1,000 hours	Yearly
Grease and Lubrication: See Lubrication Section																									
Rear Carrier Rocker	2	^																							
Wheel Swivel Bearing	2	1																							
Wheel Axle Bearing	2	^	**																						
Rotor Bearing	2	1																							
Cross Pivot Frame	2	^																							
Rear Roller Bearing	2	1																							
Jack Shaft Bearing	2	1																							
Drive Shaft	5	1																							
Upper Hitch Swivel Link	1	^																							
Lower Swivel Link	4	^																							
Check the Gearbox Oil Level																									
Change the Gearbox Oil. Replace with 75W-140 synthetic gear oil																									
Inspection																									
Inspect for Loose, Missing, or Worn Components																									
Inspect the Belts and Pulleys																									
Inspect the Blades and the Blade Mounting Bolts																									
Inspect the Safety Decals																									
Inspect the hydraulic hoses and fittings (if equipped)																									
^Grease until fresh grease is visible.																									
**Operation in severe conditions may require more frequent service intervals.																									

SPECIFICATIONS

Dimensions

MW560 Flail Mower

Overall Height	70 cm (27-3/4 inches)
Overall Length	164 cm (64-1/2 inches)
Overall Width	160 cm (63 inches)
Weight	288 kg (635 pounds)
Cutting Width	142 cm (56 inches)
Cutting Height Range	25 mm (1 inch) to 127 mm (5 inches)
Blade Count	24

MW720 Flail Mower

Overall Height	70 cm (27-3/4 inches)
Overall Length	161 cm (63-1/2 inches)
Overall Width	201 cm (79 inches)
Weight	322 kg (710 pounds)
Cutting Width	183 cm (72 inches)
Cutting Height Range	25 mm (1 inch) to 127 mm (5 inches)
Blade Count	36

Features

- Flip-up deck design
- Full length rear roller for even cutting and striping
- Side to side oscillation of the mower deck

Visit ventrac.com/manuals
for the latest version of this operator's manual.
A downloadable parts manual is also available.

View all manuals



WARRANTY



LIMITED WARRANTY - VENTRAC COMMERCIAL EQUIPMENT

Venture Products, Inc., (henceforth referred to as V.P.I.) warrants on the terms and conditions herein, that it will repair, replace, or adjust any part manufactured by Venture Products Inc., and found by Venture Products, Inc., to be defective in material and/or workmanship during the applicable warranty term.

All Ventrac commercial equipment purchased and registered on or after January 1, 2019 will carry a 2-year commercial warranty. The warranty period begins on the date of the original customer purchase:

Ventrac Commercial Equipment	Warranty Term
2100 SSV & Attachments	2-year
3000 Series Tractors & Attachments	2-year
4000 Series Tractors & Attachments	2-year

All Ventrac add-on kits and accessories such as: 3-point hitch, 12V front & rear power outlets, foot pedal, dual wheel kit, etc., will be covered under the above warranty periods provided they are installed by an Authorized Ventrac Dealer. This warranty may be transferred and will carry the remainder of the warranty starting from the original purchase/registration date with the dealership and/or V.P.I.

The engine warranty is covered by its respective engine manufacturer. Please refer to the engine manufacturer's warranty statement that is included in the owner's manual.

For warranty consideration on Ventrac commercial equipment, the equipment, including any defective part, must be returned to an Authorized Ventrac Dealer within the warranty period. The warranty shall extend to the cost to repair or replace (as determined by V.P.I.) the defective part. The expense of pickup and delivery of the equipment, the service call drive time or any transportation expense incurred for the warranty repair is the sole responsibility of the owner and is not covered under warranty by Ventrac and/or V.P.I. Ventrac and V.P.I.'s responsibility in respect to claims is limited to making the required repairs or replacements, and no claim of breach of warranty shall be cause for cancellation or rescission of the contract of sale of any Ventrac equipment. Proof of purchase may be required by the dealer to substantiate any warranty claim. Only warranty work performed and submitted by an Authorized Ventrac Dealer may be eligible for warranty credit.

This warranty extends only to Ventrac commercial equipment operated under normal conditions and properly serviced and maintained. The warranty expressly does NOT cover: (a) any defects, damage or deterioration due to normal use, wear and tear, or exposure; (b) normal maintenance services, such as cleaning, lubrication, oil change; (c) replacement of service items, such as oil, lubricants, spark plugs, belts, rubber hoses, bearings or other items subject to normal service replacement; (d) damage or defects arising out of, or relating to abuse, misuse, neglect, alteration, negligence or accident; (e) repair or replacement arising from operation of, or use of the equipment which is not in accordance with the operating instructions as specified in the operator's manual or other operational instructions provided by V.P.I.; (f) repair or replacement arising as a result of any operation from Ventrac equipment that has been altered or modified so as to, in the determination of V.P.I., adversely affect the operation, performance or durability of the equipment or that has altered, modified or affected the equipment so as to change the intended use of the product; (g) repair or replacement necessitated by the use of parts, accessories or supplies, including gasoline, oil or lubricants, incompatible with the equipment or other than as recommended in the operator's manual or other operational instructions provided by V.P.I.; (h) repairs or replacements

WARRANTY



LIMITED WARRANTY - VENTRAC COMMERCIAL EQUIPMENT

resulting from parts or accessories which have adversely affected the operation, performance or durability of the equipment; or (i) damage or defects due to or arising out of repair of the Ventrac equipment by a person or persons other than an authorized Ventrac service dealer or the installation of parts other than genuine Ventrac parts or Ventrac recommended parts.

The sole liability of V.P.I. with respect to this warranty shall be the repair and replacement as set forth herein. V.P.I. shall have no liability for any other cost, loss, or damage. In particular V.P.I. shall have no liability or responsibility for: (i) expenses relating to gasoline, oil, or lubricants; (ii) loss, cost or expense relating to transportation or delivery of turf equipment from the location of the owner or the location where used by the owner to or from any Authorized Ventrac Dealer; (iii) travel time, overtime, after hours' time or other extraordinary repair charges or charge relating to repairs or replacements outside of normal business hours at the place of business of an Authorized Ventrac Dealer; (iv) rental of like or similar replacement equipment during the period of any warranty repair or replacement work; (v) any telephone or telegram charges; (vi) loss or damage to person or property other than that covered by the terms of this warranty; (vii) any claims for lost revenue, lost profit or additional cost or expense incurred as a result of a claim of breach of warranty; or (viii) attorney's fees.

The remedies of the buyer set forth herein are exclusive and are in lieu of all other remedies. The liability of V.P.I., whether in contract, tort, under any warranty, or otherwise, shall not extend beyond its obligation as set forth herein. V.P.I. shall not be liable for cost of removal or installation nor shall V.P.I. be responsible for any direct, indirect, special or consequential damages of any nature. In no event shall V.P.I. be liable for any sum in excess of the price received for the goods for which a liability is claimed.

There are no representations or warranties which have been authorized to the buyer of the Ventrac commercial equipment other than set forth in this warranty. Any and all statements or representations made by any seller of this equipment, including those set forth in any sales literature or made orally by any sales representative, are superseded by the terms of this warranty. Any affirmation of fact or promise made by V.P.I. or any of its representatives to the buyer which relates to the goods that are the subject to this warranty shall not be regarded as part of the basis of the bargain and shall not be deemed to create any express warranty that such goods shall conform to the affirmation or promise.

No employee, distributor, or representative is authorized to change the foregoing warranties in any way or grant any other warranty on behalf of V.P.I.

Some states do not allow limitations on how long an implied warranty lasts or allow the exclusion on limitation of incidental or consequential damages, so the above limitation or exclusion may not apply to you.

This warranty gives you specific legal rights, and you may also have other rights which vary from state to state.

This warranty applies to all Ventrac commercial equipment sold by Venture Products Inc.