



Operator's Manual

KW452

Weather Cab





500 Venture Drive
Orrville, OH 44667
www.ventrac.com

To the Owner Contact Information and Product Identification

If you need to contact an authorized Ventrac dealer for information on servicing your product, always provide the product model and serial numbers.

Please fill in the following information for future reference. See the picture(s) below to find the location of the identification numbers. Record them in the spaces provided.

Dealer _____ Date of Purchase: _____

Dealer Address: _____

Dealer Phone Number: _____ Dealer Fax Number: _____

With your mobile device, you can scan the QR code on the serial number plate to access manuals, warranty, and other product information.



Model # _____

Serial # _____



Venture Products Inc. reserves the right to make changes in design or specifications without obligation to make like changes on previously manufactured products.

TABLE OF CONTENTS

INTRODUCTION	PAGE 5
Product Description	5
Why Do I Need an Operator’s Manual?	5
Using Your Manual	6
Manual Glossary	6
SAFETY	PAGE 7
General Safety Procedures	7
Training Required	7
Requirements for Personal Protective Equipment (PPE)	7
Operation Safety.	7
Keep Riders Off	9
Operating On Slopes	9
Truck Or Trailer Transport	10
Maintenance	10
Fuel Safety	11
Hydraulic Safety	12
Safety Decals.	14
SETUP INSTRUCTIONS	PAGE 16
Identification of Parts	16
Setup Instructions for the Power Unit and the Weather Cab.	18
OPERATIONAL CONTROLS	PAGE 30
Operational Control Locations	30
Outer Door Handle and Lock (A)	30
Inner Door Handle (B)	30
Window Latch Handle (C)	30
Interior Light Switch (D)	30
Hazard Light Switch (E)	30
Strobe Light Switch (F)	31
Rear Work Light Switch (G)	31
Front Work Light Switch (H)	31
Windshield Wiper / Washer Switch (I)	31
Heater Fan Speed Switch (J)	31
Heater Temperature Switch (K)	31
USB Receptacle (L)	31
Rear Heater Vent (M)	31
Main Heater Vents (N)	31
Defrost Fan and Switch (O)	31
GENERAL OPERATION	PAGE 32
Daily Inspection	32
4-Point Seat Belt	32
Strobe Light	32

TABLE OF CONTENTS

SERVICE	PAGE 33
Cleaning and General Maintenance	33
Seat Belt Upper Mount Adjustment	33
Window Latch Adjustment	33
Window Latch Handle Adjustment	33
Door Latch Adjustment	33
Door Latch Lubrication	34
Lower Door Window Adjustment	34
Fuse Replacement	34
Wiper Blade Replacement	35
Windshield Washer Nozzle Inspection and Adjustment	35
Changing the Strobe Light Flasher Mode.	35
Strobe Light Pin Lubrication	35
Heater Air Filter Replacement	36
Storage	36
Power Unit Tire Pressure	37
SPECIFICATIONS	PAGE 38
Dimensions.	38
Features.	38

INTRODUCTION



Venture Products Inc. is pleased to provide you with your new Ventrac KW452 weather cab! We hope that Ventrac equipment will provide you with a ONE Tractor Solution.

Please visit our website, or contact your authorized Ventrac dealer for a complete list of items available for your new KW452 weather cab.

	Item Description	Part Number
Accessories	Defrost Fan Kit	70.2006-6
	Hazard Light Kit	70.8162
	Mirror Kit	70.2006-4
	Strobe Light Kit	70.8161
	Windshield Washer Kit	70.8148
	KW452 Heater Install Kit (4500Y/4520Y Kubota diesel)	70.2014-51
	KW452 Heater Install Kit (4500P/4520P Kawasaki)	70.2014-52
	KW452 Heater Install Kit (4500Z/4520Z Kubota gas)	70.2014-53
	Lift Sling	47.0381

Product Description

The Ventrac KW452 weather cab is designed for the sole purpose of sheltering the operator from the weather while providing superior visibility. Standard features include a front windshield wiper, front and rear LED work lights, a large left-side entry door, right-side emergency exit, door and side windows that can be quickly and easily removed, and a 4-point seat belt. All cabs with serial # 01287 and higher are equipped with a heater. A heater installation kit must be purchased to connect the heater to your power unit engine.

Optional accessories include a strobe light, hazard lights, mirrors, windshield washer, and defrost fan kits. Refer to your national and/or local regulations for lighting requirements specific to your intended application.

NOTE: the KW452 weather cab cannot be used with the Ventrac KH500 or KM500 loaders, the Ventrac RV602 collection vacuum, or the 70.4137 mid weight bar kit. The KW452 weather cab should not be used with a ballpark groomer equipped with a groomer drag kit. When the groomer drag is folded up and the ballpark groomer is raised, the groomer drag handle may contact and break the rear window of the cab.

Why Do I Need an Operator's Manual?

This manual has been created to help you gain the important knowledge of what is needed to safely operate and maintain your machine, and to avoid injury and product damage. It is divided into chapters for convenient reference of the appropriate information.

You must read and understand the operator's manual for each piece of Ventrac equipment you own. Reading the operator's manual will help you become familiar with each specific piece of equipment. If this manual becomes damaged or unreadable, it should be replaced immediately. Contact your local Ventrac dealer for a replacement.

When using a Ventrac attachment, be sure to read and follow the safety and operating instructions of both the power unit and the attachment being used to ensure the safest operation possible.

The information in this manual provides the operator with the safest procedures to operate the machine while getting the maximum use out of the unit. Failure to follow the safety precautions listed in this manual may result in personal injury and/or damage to the equipment.

INTRODUCTION

Using Your Manual

This manual identifies potential hazards and safety concerns to help you, as well as others, avoid personal injury and/or damage to the equipment.

Safety should always be the first priority when working on or operating equipment. Accidents are more likely to occur when proper operating procedures are not followed or inexperienced operators are involved.

SYMBOL DEFINITIONS



This symbol identifies potential health and safety hazards. It marks safety precautions. Your safety and the safety of others is involved.

There are three signal words that describe the level of safety concern: Danger, Warning, and Caution.

SIGNAL WORD DEFINITIONS

DANGER

Indicates an imminently hazardous situation which, if not avoided, will result in death or serious injury. This signal word is limited to the most extreme cases.

WARNING

Indicates a potentially hazardous situation which, if not avoided, could result in death or serious injury.

CAUTION

Indicates a potentially hazardous situation which, if not avoided, may result in minor or moderate injury and/or property damage. It may also be used to alert against unsafe practices.

This manual also uses two words to highlight information. **ATTENTION** calls attention to special mechanical information to prevent equipment damage and/or best practices for equipment service and care.

NOTE emphasizes general information that is worthy of special attention.

Note: Right-Hand and Left-Hand orientations may be referred to at different places throughout this manual. Right-Hand and Left-Hand is determined as if facing forward from the operator station.

Manual Glossary

- Power Unit** A Ventrac tractor or other Ventrac engine powered device that may be operated by itself or with an attachment or accessory.
- Attachment** A piece of Ventrac equipment that requires a Power Unit for operation.
- Accessory** A device that attaches to a Power Unit or Attachment to extend its capabilities.
- Machine** Describes any "Attachment" or "Accessory" that is used in conjunction with a power unit.

SAFETY



General Safety Procedures for Ventrac Power Units, Attachments, & Accessories



Training Required

- The owner of this machine is solely responsible for properly training the operators.
- The owner/operator is solely responsible for the operation of this machine and for the prevention of accidents or injuries occurring to him/herself, other people, or property.
- Do not allow operation or service by children or untrained personnel. Local regulations may restrict the age of the operator.
- Before operating this machine, read the operator's manual and understand its contents.
- If the operator of the machine cannot understand this manual, then it is the responsibility of this machine's owner to fully explain the material within this manual to the operator.
- Learn and understand the use of all the controls.
- Know how to stop the power unit and the attachments quickly in the event of an emergency.

Requirements for Personal Protective Equipment (PPE)

- The owner is responsible for ensuring that all the operators use the proper PPE while operating the machine. Whenever you use the machine, use the following PPE:
- Certified eye protection and hearing protection.
- Closed toe, slip resistant footwear.
- Long pants or trousers.
- A dust mask for dusty conditions.
- Additional PPE may be required. Refer to the product safety procedures for any additional requirements.

Operation Safety

- Secure long hair and loose clothing. Do not wear jewelry.
- Inspect the machine before operation. Repair or replace any damaged, worn, or missing parts. Be sure the guards and shields are in proper working condition and are secured in place. Make any necessary adjustments before operating the machine.
- Some pictures in this manual may show shields or covers opened or removed in order to clearly illustrate the instructions. Under no circumstance should the machine be operated without these devices in place.
- Alterations or modifications to this machine can reduce safety and could cause damage to the machine. Do not alter the safety devices or operate with the shields or covers removed.
- Before each use, verify that all the controls function properly and inspect all the safety devices. Do not operate if the controls or safety devices are not in proper working condition.
- Check the parking brake function before operating. Repair or adjust the parking brake if necessary.
- Observe and follow all of the safety decals.
- All the controls are to be operated from the operator's station only.
- Always wear a seat belt if the machine has a roll cage/bar installed and in the upright position.

SAFETY



General Safety Procedures for Ventrac Power Units, Attachments, & Accessories



- Ensure the attachment or accessory is locked or fastened securely to the power unit before operating.
- Ensure that all bystanders are clear of the power unit and the attachment before operating. Stop the machine if someone enters your work area.
- Always be alert to what is happening around you, but do not lose focus on the task you are performing. Always look in the direction the machine is moving.
- Look behind and down before backing up to be sure of a clear path.
- If you hit an object, stop and inspect the machine. Make any necessary repairs before operating the machine again.
- Stop operation immediately at any sign of equipment failure. An unusual noise can be a warning of equipment failure or a sign that maintenance is required. Make any necessary repairs before operating the machine again.
- If equipped with a high/low range feature, never shift between high and low range while on a slope. Always move the machine to level ground and engage the parking brake before shifting range.
- Do not leave the machine unattended while it is running.
- Always park the machine on level ground.
- Always shut off the engine when connecting the attachment drive belt to the power unit.
- Never leave the operator's station without lowering the attachment to the ground, engaging the parking brake, shutting off the engine, and removing the ignition key. Make sure all moving parts have come to a complete stop before dismounting.
- Never leave the machine unattended without lowering the attachment to the ground, engaging the parking brake, shutting off the engine, and removing the ignition key.
- Only operate in well-lit conditions.
- Do not operate when there is a risk of lightning.
- Never direct the discharge of any attachment in the direction of people, buildings, animals, vehicles, or other objects of value.
- Never discharge material against a wall or obstruction. The material may ricochet back toward the operator.
- Use extra caution when approaching blind corners, shrubs, trees, or other objects that may obscure your vision.
- Do not run the engine in a building without adequate ventilation.
- Do not touch the engine or the muffler while the engine is running or immediately after stopping the engine. These areas may be hot enough to cause a burn.
- Do not change the engine governor settings or over-speed the engine. Operating the engine at excessive speeds may increase the hazard of personal injury.
- To reduce the hazard of fire, keep the battery compartment, engine, and muffler areas free of grass, leaves, excessive grease, and other flammable materials.
- Clear the working area of objects that might be hit or thrown from the machine.

SAFETY



General Safety Procedures for Ventrac Power Units, Attachments, & Accessories



- Keep people and pets out of the working area.
- Know the work area well before operation. Do not operate where traction or stability is questionable.
- Reduce speed when you are operating over rough ground.
- Equipment can cause serious injury and/or death when improperly used. Before operating, know and understand the operation and safety of the power unit and the attachment being used.
- Do not operate the machine if you are not in good physical and mental health, if you will be distracted by personal devices, or if you are under the influence of any substance which might impair your decisions, dexterity, or judgment.
- Children are attracted to machine activity. Be aware of children and do not allow them in the work area. Turn off the machine if a child enters the work area.
- Power units, attachments, and accessories are not designed or intended for travel on public roadways. Never operate or travel on public roads or highways.
- Operate with safety lights when operating near roadways.
- Slow down and be careful of traffic when operating near or crossing roadways. Stop before crossing roads or sidewalks. Use care when approaching areas or objects that may obscure vision.

Keep Riders Off

- Only allow the operator on the power unit. Keep riders off.
- Never allow riders on any attachment or accessory.

Operating On Slopes

- Slopes can cause loss-of-control and tip-over accidents, which can result in severe injury or death. Be familiar with the emergency parking brake, along with the power unit controls and their functions.
- If the power unit is equipped with a fold down roll bar, it must be locked in the upright position when operating on any slope.
- Use low range (if equipped) when operating on slopes greater than 15 degrees.
- Do not stop or start suddenly when operating on slopes.
- Never shift between high and low range while on a slope. Always move the power unit to level ground and engage the parking brake before shifting range or placing the power unit in neutral.
- Variables such as wet surfaces and loose ground will reduce the degree of safety. Do not drive where the machine could lose traction or tip over.
- Keep alert for hidden hazards in the terrain.
- Stay away from drop-offs, ditches, and embankments.
- Sharp turns should be avoided when operating on slopes.
- Pulling loads on hills decreases safety. It is the responsibility of the owner/operator to determine loads that can safely be controlled on slopes.

SAFETY



General Safety Procedures for Ventrac Power Units, Attachments, & Accessories



- Transport the machine with the attachment lowered or close to the ground to improve stability.
- While operating on slopes, drive in an up and down direction whenever possible. If turning is necessary while driving across slopes, reduce your speed and turn slowly in the downhill direction.
- Ensure a sufficient supply of fuel for continuous operation. A minimum of one-half tank of fuel is recommended.

Truck Or Trailer Transport

- Use care when loading or unloading the machine into a truck or trailer.
- Use full width ramps for loading the machine into a truck or trailer.
- The parking brake is not sufficient to lock the machine during transport. Always secure the power unit and/or attachment to the transporting vehicle securely using straps, chains, cables, or ropes. Both the front and rear straps should be directed down and outward from the machine.
- Shut off the fuel supply to the power unit during transport on a truck or trailer.
- If equipped, turn the battery disconnect switch to the Off position to shut off electrical power.

Maintenance

- Keep the safety decals legible. Remove all grease, dirt, and debris from the safety decals and instructional labels.
- If any decals are faded, illegible, or missing, contact your dealer promptly for replacements.
- When new components are installed, be sure that the current safety decals are affixed to the replacement components.
- If any component requires replacement, use only original Ventrac replacement parts.
- Always turn the battery disconnect to the Off position or disconnect the battery before performing any repairs. Disconnect the negative terminal first and the positive terminal last. Reconnect the positive terminal first and the negative terminal last.
- Keep all bolts, nuts, screws, and other fasteners properly tightened.
- Always lower the attachment to the ground, engage the parking brake, shut off the engine, and remove the ignition key. Make sure all moving parts have come to a complete stop before cleaning, inspecting, adjusting, or repairing.
- If the power unit, attachment, or accessory requires repairs or adjustments not instructed in the operator's manual, the power unit, attachment, or accessory must be taken to an authorized Ventrac dealer for service.
- Never perform maintenance on the power unit and/or attachment if someone is in the operator's station.
- Always use protective glasses when handling the battery.
- Check the fuel lines for tightness and wear on a regular basis. Tighten or repair them as needed.
- To reduce the hazard of fire, keep the battery compartment, engine, and muffler areas free of grass, leaves, and excess grease.
- Do not touch the engine, the muffler, or other exhaust components while the engine is running or immediately after stopping the engine. These areas may be hot enough to cause a burn.

SAFETY



General Safety Procedures for Ventrac Power Units, Attachments, & Accessories



- Allow the engine to cool before storing and do not store near an open flame.
- Do not change the engine governor settings or over-speed the engine. Operating engine at excessive speeds may increase the hazard of personal injury.
- Springs may contain stored energy. Use caution when disengaging or removing springs and/or spring loaded components.
- An obstruction or blockage in a drive system or moving/rotating parts may cause a buildup of stored energy. When the obstruction or blockage is removed, the drive system or moving/rotating parts may move suddenly. Do not attempt to remove an obstruction or blockage with your hands. Keep your hands, feet, and clothing away from all power-driven parts.

Fuel Safety

- To avoid personal injury or property damage, use extreme care in handling gasoline. Gasoline is extremely flammable and the vapors are explosive.
- Do not refuel the machine while smoking or at a location near flames or sparks.
- Always refuel the machine outdoors.
- Do not store the machine or fuel container indoors where the fumes or fuel can reach an open flame, spark, or pilot light.
- Only store fuel in an approved container. Keep out of the reach of children.
- Never fill containers inside a vehicle or on a truck or trailer bed with a plastic liner. Always place the containers on the ground away from your vehicle before filling.
- Remove the machine from the truck or trailer and refuel it on the ground. If this is not possible, refuel the machine using a portable container, rather than from a fuel dispenser nozzle.
- Never remove the fuel cap or add fuel with the engine running. Allow the engine to cool before refueling.
- Never remove the fuel cap while on a slope. Only remove the fuel cap when parked on a level surface.
- Replace the fuel tank cap and the container cap securely.
- Do not overfill the fuel tank. Only fill to the bottom of the fuel neck, do not fill the fuel neck full. Overfilling of the fuel tank could result in engine flooding, fuel leakage from the tank, and/or damage to the emissions control system.
- If fuel is spilled, do not attempt to start the engine. Move the power unit away from the fuel spill and avoid creating any source of ignition until the fuel vapors have dissipated.
- If the fuel tank must be drained, it should be drained outdoors into an approved container.
- Check the fuel lines for tightness and wear on a regular basis. Tighten or repair them as needed.
- The fuel system is equipped with a shut-off valve. Shut off the fuel when transporting the machine to and from the job, when parking the machine indoors, or when servicing the fuel system.

SAFETY



General Safety Procedures for Ventrac Power Units, Attachments, & Accessories



Hydraulic Safety

- Make sure the hydraulic connections are tight and all hydraulic hoses and tubes are in good condition. Repair any leaks and replace any damaged or deteriorated hoses or tubes before starting the machine.
- Hydraulic leaks can occur under high pressure. Hydraulic leaks require special care and attention.
- Use a piece of cardboard and a magnifying glass to locate suspected hydraulic leaks.
- Keep your body and hands away from pinhole leaks or nozzles that eject high pressure hydraulic fluid. Hydraulic fluid escaping under high pressure can penetrate the skin causing serious injury, leading to severe complications and/or secondary infections if left untreated. If hydraulic fluid is injected into the skin, seek immediate medical attention no matter how minor the injury appears.
- The hydraulic system may contain stored energy. Before performing maintenance or repairs on the hydraulic system, remove any attachments, engage the parking brake, disengage the weight transfer system (if equipped), shut off the engine, and remove the ignition key. To relieve pressure on the auxiliary hydraulic system, shut off the power unit engine and move the hydraulic control lever left and right before disconnecting the auxiliary hydraulic quick couplers.

SAFETY



KW452 Safety Procedures



- The installation of the weather cab onto a power unit reduces the slope rating of the power unit to a 10 degree maximum angle of operation.
- Do not operate if visibility is restricted due to snow or ice accumulations or due to fogging of the windows. Clear any ice or snow from the windows and windshield wiper and/or defrost the windows prior to operation.
- The cab door must be closed and latched during operation of the power unit and KW452 weather cab.
- Window latches must be locked in either the closed or open position during operation of the power unit and KW452 weather cab.
- Do not place any part of your body outside of the cab (through the windows, door, or any other opening) during operation of the power unit and KW452 weather cab.
- Do not place your hands or fingers between power unit dash and cab front frame cross member. Pinch points may be created by the oscillation of the power unit front frame.
- Always wear the 4-point seat belt when operating a power unit and KW452 weather cab. The seat belt must be adjusted to fit individual operators.
- Do not operate the power unit and KW452 weather cab without the headrest cushion in place.
- The KW452 weather cab is equipped with an emergency exit (the right side front window). Learn to use the emergency exit prior to operating the power unit and KW452 weather cab. Refer to the Operational Controls section of this manual for instructions on using the emergency exit.
- The power unit's steering cylinder must be installed in the outer position when equipped with a KW452 weather cab. Damage to the power unit and/or the weather cab will occur if the steering cylinder is installed in the center or inner positions. Refer to Setup section for steering cylinder mounting instructions.
- Do not exceed 30 amp draw to the weather cab and additional accessories.

SAFETY

Safety Decals

The following safety decals must be maintained on your weather cab.

Keep all safety decals legible. Remove all grease, dirt, and debris from safety decals and instructional labels. If any decals are faded, illegible, or missing, contact your dealer promptly for replacements.

When new components are installed, be sure that current safety decals are affixed to the replacement components.

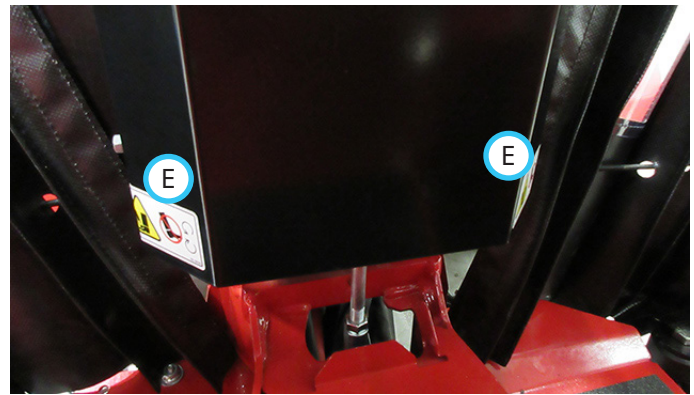

Heater Kit - Kubota Engines Only

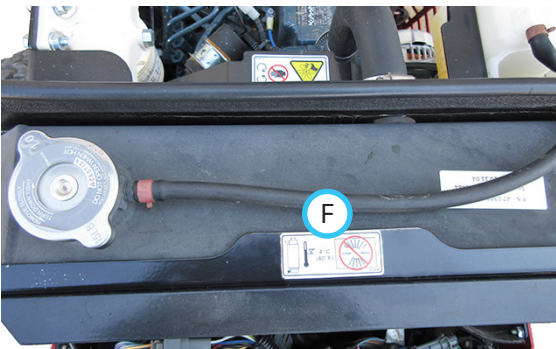

1. Pinching or crushing hazard. Stay away from moving parts.

SAFETY

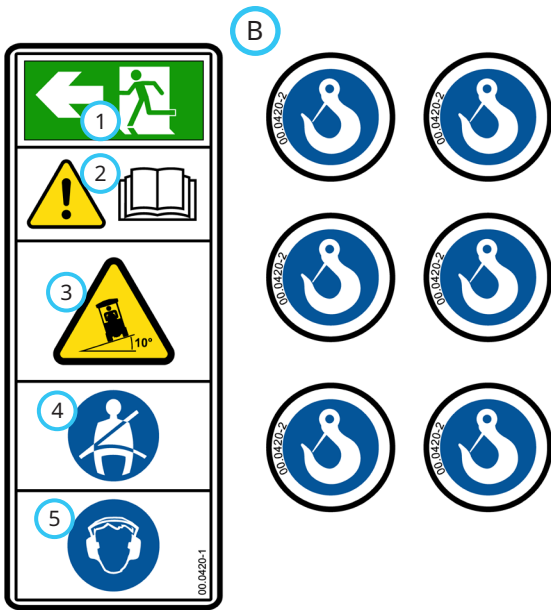

1. Emergency exit.
2. Read the operator's manual.
3. Maximum angle of operation is 10 degrees.
4. Always wear a the 4-point seat belt.
5. Wear certified hearing protection.



1. Warning - explosion/fire hazard.
2. Keep away from fire, sparks, and pilot lights when refueling or storing machine and fuel.
3. Smoking is prohibited.
4. Use unleaded gasoline only with an ethanol content of 10 percent or less.

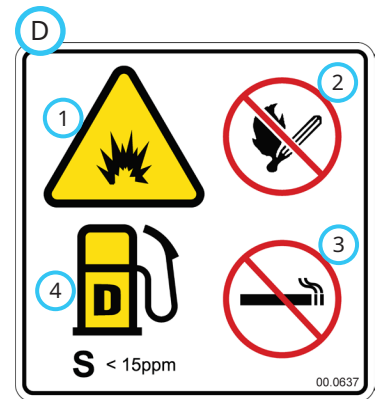

1. Warning - explosion/fire hazard.
2. Keep away from fire, sparks, and pilot lights when refueling or storing machine and fuel.
3. Smoking is prohibited.
4. Use ultra low sulphur diesel fuel only.



1. Pinching or crushing hazard - foot. Stay away from moving parts.

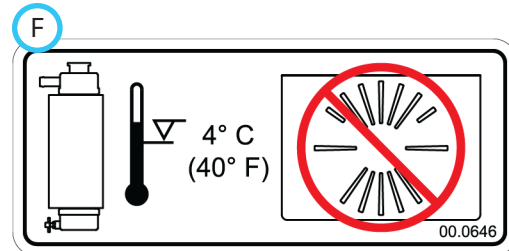

Heater Kit - Kubota Engines Only

1. The radiator baffle must be removed when the outside air temperature is 4° C (40° F) or above.

Decal	Description	Part Number	Quantity
A	Warning, Pinch Point	00.0364	2
B	Warning, KW452	00.0420	1
C	Gasoline Safety	00.0457	1
D	Diesel Safety	00.0637	1
E	Pinching Hazard, Foot	00.0639	2
F	Radiator Baffle	00.0646	1

SETUP INSTRUCTIONS

Identification of Parts

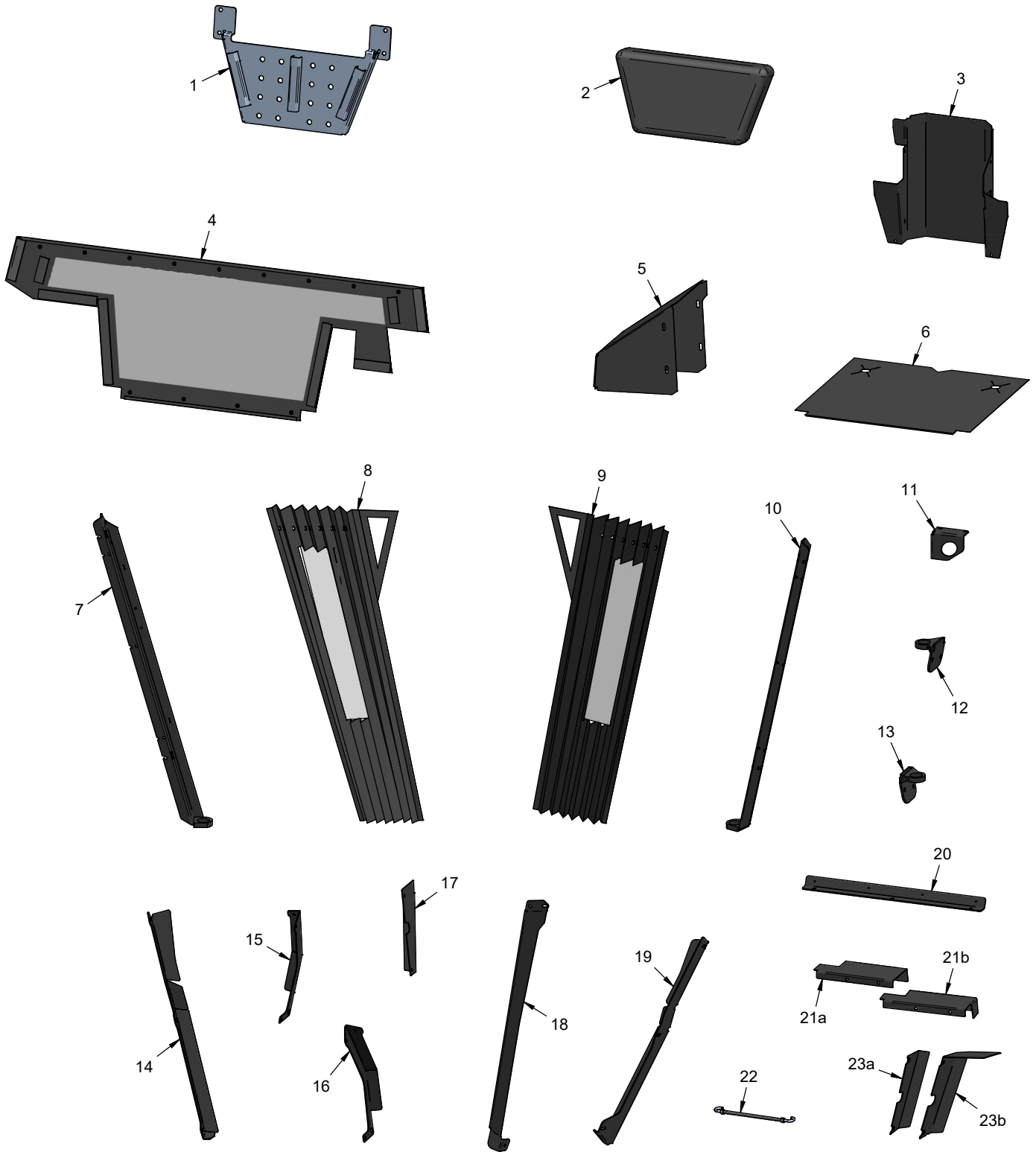

SETUP INSTRUCTIONS

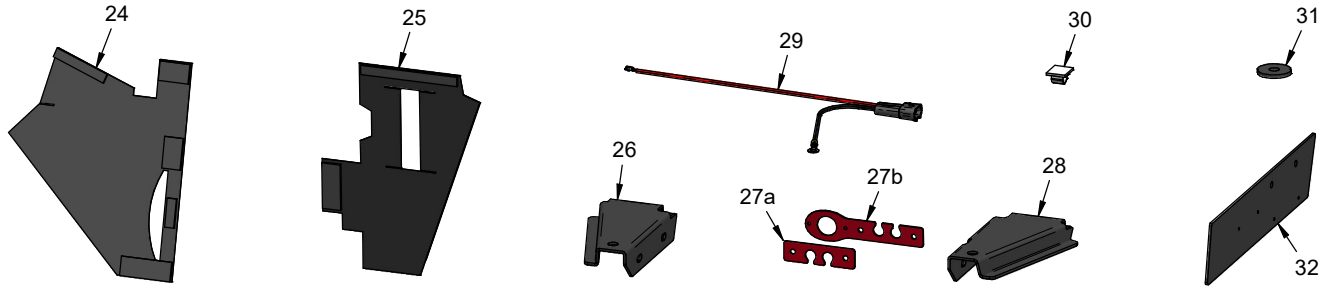

Ref.	Name	Qty.
1	Mount, Seat Belt Upper (w/seat belt)	1
2	Cushion, Headrest	1
3	Cover, Pump W/Flanges	1
4	Window, Lower Rear Canvas	1
5	Cover, Fuel Tank	1
6	Canvas, Rear Frame	1
7	Support, Cab Front RH	1
8	Canvas, Pleated Right	1
9	Canvas, Pleated Left	1
10	Support, Cab Front LH	1
11	Bracket, Mount Support	1
12	Mount, Cab Rear Right	1
13	Mount, Cab Rear Left	1
14	Bracket, Window Lower Right	1
15	Mount, Canvas Column Right	1
16	Mount, Canvas Column Left	1
17	Bracket, Window Rear Right	1
18	Support, Door Window Lower	1
19	Bracket, Window Door Lower	1
20	Mount, Window Rear Lower	1
21a	Bracket, Window Rear Top (4500)	1
21b	Bracket, Window Rear Top (4520)	1
22	Strap, Bellows Support	4
23a	Bracket, Window Rear Left (4500)	1
23b	Bracket, Window Rear Left (4520)	1
24	Canvas, Column Right	1
25	Canvas, Column Left	1
26	Mount, Cab Front Right	1
27a	Cover, Wire Harness Access (4500)	1
27b	Cover, Wire Harness Access (4520)	1
28	Mount, Cab Front Left	1
29	Harness, Wire Tractor To KW452	1
30	Clamp, Wire Mt Adh. 1/2 Gray	1
31	Washer, .531 x 1.75 3/16 Thick	4
32	Plate, Drill Template	1
33*	Decal, Gasoline Safety	1

Ref.	Name	Qty.
34*	Decal, Diesel Safety	1
35*	Grommet, 7/16ID, 3/4OD, 1/4Thk	2
36*	Tyton Tie, #50 .18 x 8 Black	4
37*	Breaker, Circuit 30 Amp Mini	1
38*	Velcro, Loop 1/2" Black x 2" long	1
39*	Velcro, Loop 1/2" Black x 5" long	1
40*	Velcro, Loop 1/2" Black x 16" long	1
41*	Velcro, Loop 1" Black x 1" long	1
42*	Velcro, Loop 1" Black x 2-1/2: long	1
43*	Velcro, Loop 1" Black x 4" long	1
44*	Velcro, Loop 1" Black x 8" long	2
45*	Key, Door Handle	2
46*	U-bolt, 3/8-16 2-1/16 ID Sq	4
47*	Bolt, 1/4-20 x 1/2 BSCS	2
48*	Bolt, 1/4-20 x 3/4 BSCS	18
49*	Bolt, Step 1/4-20 x 1 Black	4
50*	Bolt, 5/16-18 USS x 3/4	5
51*	Bolt, 5/16-18 USS x 1	1
52*	Bolt, 7/16-14 USS x 1-1/4	2
53*	Bolt, 1/2-13 USS x 3	4
54*	Washer, Flat 1/4 SAE	6
55*	Washer, Flat 5/16 SAE	6
56*	Washer, Flat 7/16 SAE	8
57*	Isolator, .53 ID x 1.87 OD	4
58*	Nut, SRF 1/4-20 USS	12
59*	Nut, SRF 5/16-18 USS	4
60*	Nut, Locking Flange 5/16-18	2
61*	Nut, Locking Flange 3/8-16	8
62*	Locknut, Stover 7/16-14 USS	2
63*	Nut, Locking Flange 1/2-13	4

*Item not pictured.

SETUP INSTRUCTIONS

Setup Instructions for the Power Unit and the Weather Cab

Installation Time (estimated)

3.0 hours

WARNING

Engage the parking brake, shut off the power unit engine, remove the ignition key, and ensure that all moving parts have come to a complete stop before starting installation or attempting any repair or adjustment.

Always disconnect the negative battery cable from the battery when working with electrical components.

WARNING

Safety glasses must be worn during installation. Hearing protection must be worn when using air or power tools.

WARNING

To lift the cab, use a Ventrac lift sling (part number 47.0381) attached to the four corner lift points or remove the cab roof and attach a lifting device with a minimum rating of 226 kg (500 lbs) to the two lift points inside the cab roof.

Never walk or stand beneath the cab when it is raised off the ground.

WARNING

Place wheel chocks in front and back of the wheels to prevent the power unit from moving during setup of the power unit and weather cab.

Unless specified otherwise, use the bolt torque specifications listed below for all bolts used during the installation of the weather cab.

Bolt Torque Specifications

Bolt Size	Torque (Metric)	Torque (English)
1/4-20	11 Nm	100 in-lb
5/16-18	24 Nm	210 in-lb
3/8-16	42 Nm	31 ft-lb
7/16-14	68 Nm	50 ft-lb
1/2-13	102 Nm	75 ft-lb

1. Place wheel chocks in front and back of the wheels to prevent the power unit from moving.
2. Disconnect the negative battery cable from the power unit's battery.
3. If the power unit is equipped with roll bar mounted light kits (work lights, strobe lights, etc.), the lights must be removed from the roll bar. If the cab will be removed in warm weather and the light kits will be reinstalled, the wire harnesses can be left in place. If the kit is to be permanently removed, the wire harnesses will need to be removed.
4. If removing a work light kit wire harness, disconnect the wire harness inside the right fender. Remove the connector from the wire harness using a metri-pack terminal removal tool. After pulling the wire harness from the roll bar, remove the fuse from slot 6 in the front fuse panel. Remove the light switch from the dash [4500] or the control panel [4520] and install a blank plug into the cutout.
5. If removing a directional/hazard signal light kit wire harness, disconnect the wire harness splitter from the power unit wire harness. Disconnect the left and right wire harnesses from the harness splitter. Remove the connectors from the left and right harness ends using a metri-pack terminal removal tool and pull the left and right wire harnesses out of the roll bar. Remove the 10 amp fuse from slot 7 in the front fuse panel, unless the power unit is equipped with a back up alarm. If the power unit is equipped with a horn kit, replace the 10 amp fuse with a 5 amp fuse. Remove the turn signal switch and the hazard light switch from the dash [4500] or the control panel [4520], along with the switch connector harness and the directional/hazard module and install blank plugs into the cutouts.
6. If removing a strobe light kit wire harness, disconnect the wire harness inside the right fender. Remove the connector from the wire harness using a metri-pack terminal removal tool. After pulling the wire harness from the roll bar, remove the fuse from slot 6 in the front fuse panel. Remove the light switch from the dash [4500] or the control panel [4520] and install a blank plug into the cutout.
7. If the power unit is equipped with a propane kit, the propane hose and wire harness must be disconnected from the lock off valve, and the propane posts must be removed from the mount brackets. This will be reinstalled after the cab is in place.

SETUP INSTRUCTIONS

8. Check the left and right outside flanges of the lower rear frame. If your power unit has the lower set of mounting holes (A), skip to step 13.

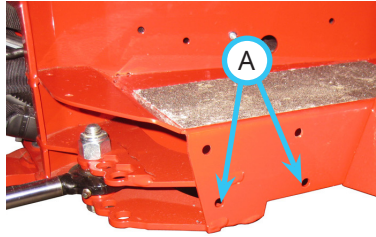

9. Install the included template onto the right side of the lower rear frame. Fasten to the upper set of holes using 5/16 inch bolts and nuts, making sure to keep the template parallel with the top surface of the foot platform. Drill 1/8 inch pilot holes (B) into the flange.

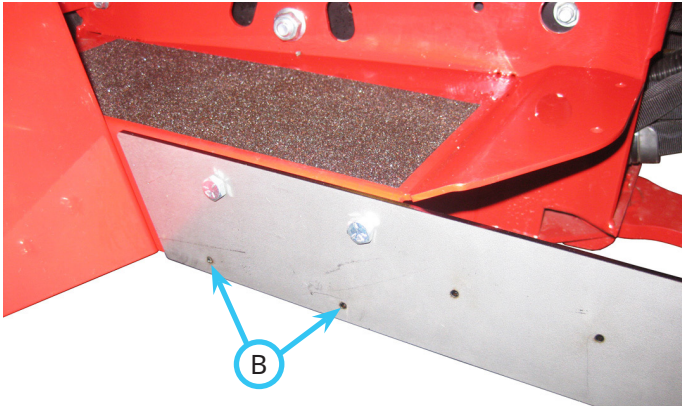

10. Move the template to the flange on the left side of the lower rear frame and drill 1/8 inch pilot holes.
11. Drill out the four holes to 11/32 inch, remove any metal shavings, and use red touch up paint on the drilled holes.
12. Position the template on top of the right foot platform, aligning it with the frame and the bend on the foot platform. Clamp the template in place.

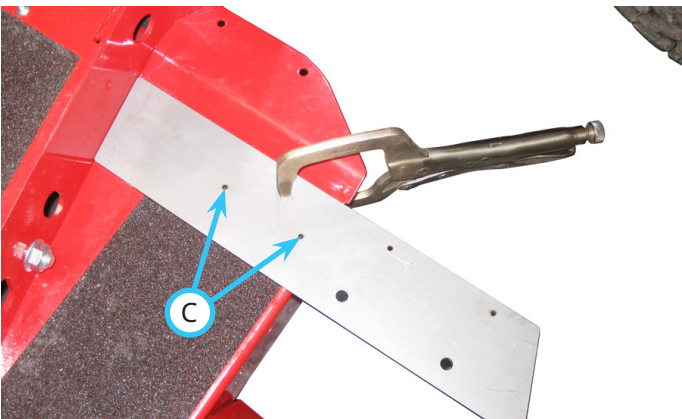

13. Drill 1/8 inch pilot holes (C) in the foot platform. NOTE: some units may already have the outside hole in the foot plate covered by the flex tread.

14. Drill out the pilot holes to 9/32 inch, remove any metal shavings, and use red touch up paint on the drilled holes.

15. Install the mount support bracket (11) under the right foot platform. Fasten loosely with two 1/4 x 3/4 inch button head bolts (48) and flange nuts.

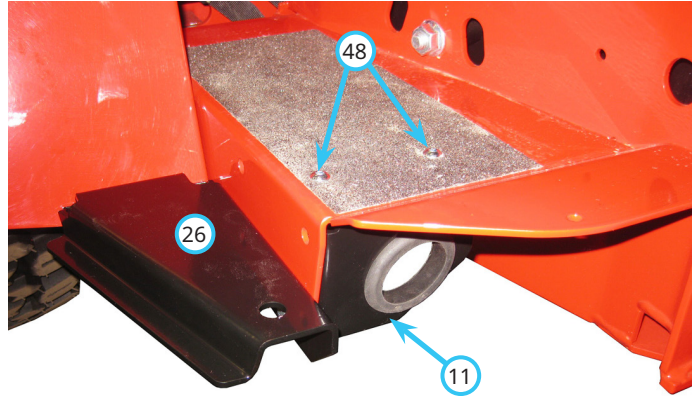

16. Install the right front cab mount (26) on the lower mounting holes in the lower rear frame. Fasten with a 5/16 x 3/4 inch bolt and flat washer through the rear mounting hole and a 5/16 x 1 inch bolt and flat washer through the front mounting hole and secure with flange nuts. Tighten the 5/16 inch bolts and then the 1/4 inch bolts for the mount support bracket.

17. Install the left front cab mount (28) on the lower mounting holes in the lower rear frame. Fasten with two 5/16 x 3/4 inch bolts and flat washers and secure with flange nuts. Tighten the 5/16 inch bolts.

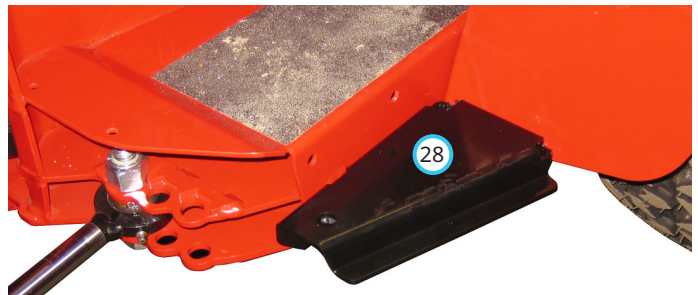

SETUP INSTRUCTIONS

18. Install the power unit's steering cylinder in the outer position (F). Torque to 230 Nm (170 ft-lb).

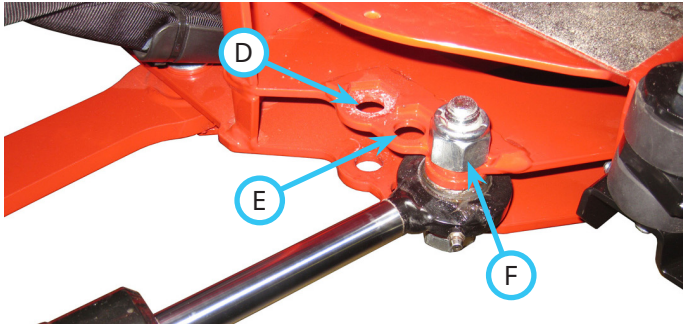

D. Inner Position
E. Center Position

F. Outer Position

ATTENTION

Failure to install the power unit's steering cylinder in the outer position will result in damage to the power unit and/or the weather cab.

19. Remove the left and right foot pegs from the power unit front frame. Reinstall the bolts and tighten.

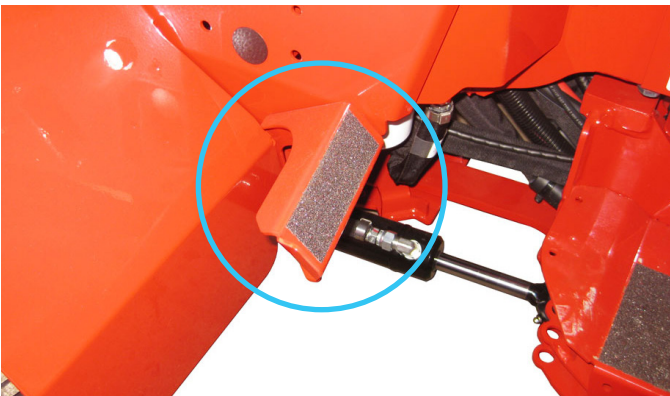

20. Remove the right dash access panel.
21. Install the right canvas column mount (15) and the dash access panel onto the dash using two 1/4 x 3/4 inch button head bolts and flange nuts with one 1/4 inch washer (G) on the top bolt between the canvas column mount and the dash access panel and two 1/4 inch washers (H) on the bottom bolt between the canvas column mount and the dash access panel.

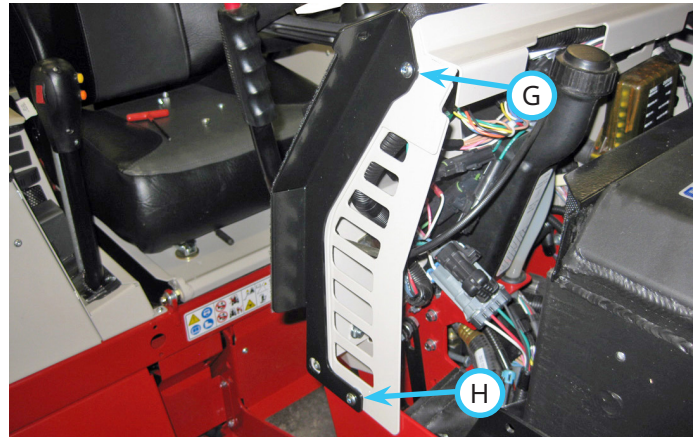

22. Repeat for the left canvas column cover (16).
23. Replace the pump cover on the power unit with the included pump cover (3) with flanges.

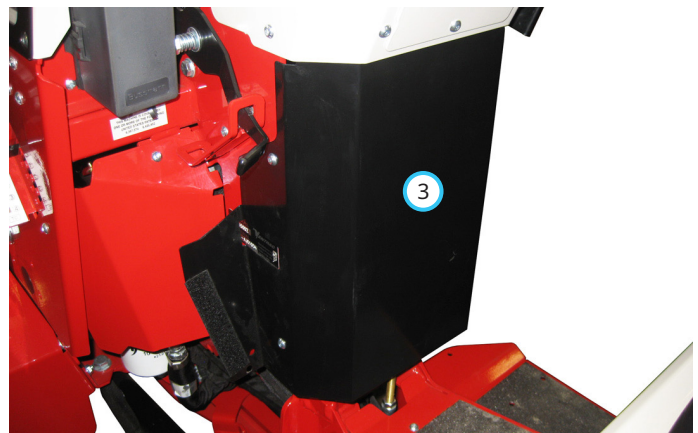

SETUP INSTRUCTIONS

ATTENTION

Prior to installing the Velcro strips, clean the area thoroughly with alcohol wipes or other cleaning wipes that will not leave residue.

24. Install a 5 inch length of 1/2 inch Velcro loop (39) to the left dash panel above the fuse panel.

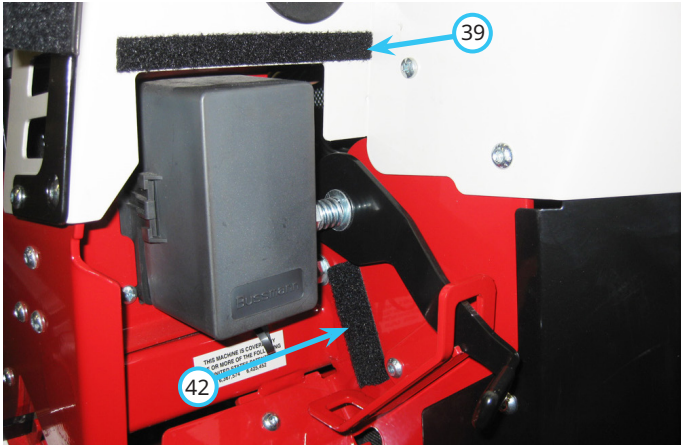

25. Install a 2-1/2 inch length of 1 inch Velcro loop (42) to the front frame between the high/low shift lever and the high/low shift lock bracket.

26. Install a 2 inch length of 1/2 inch Velcro loop (38) to the parking brake cover in front of the brake lever.

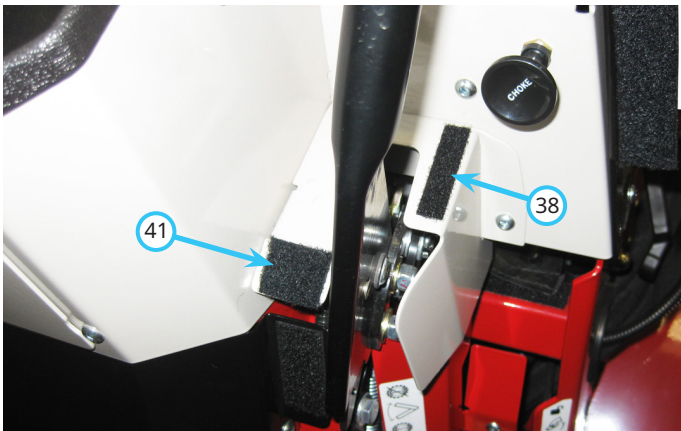

27. Install a 1 inch length of 1 inch Velcro loop (41) to the parking brake cover between the brake lever and the center dash panel.

28. Open the toolbox lid and remove the left (I) and right (J) toolbox liner panels [4500] or remove the control panel (K) [4520].

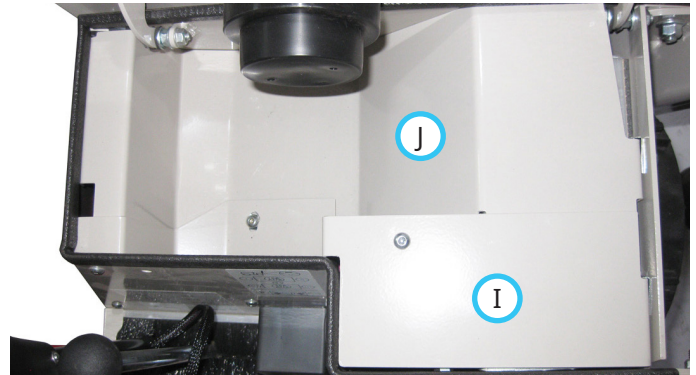

29. Choose the correct tractor harness for your power unit. 4500 and 4520 power units with serial # 01001-02232 use harness number 32.0129. 4520 power units with serial number 02233 and higher use harness number 32.0243.
30. Place the wire harness in the power unit's seat box area. Connect the ring terminal to the ground stud (L). Route the wire with the terminal along the main harness into the right fender. Use zip ties to fasten the wires to the main harness. Clip the excess ends from the zip ties.

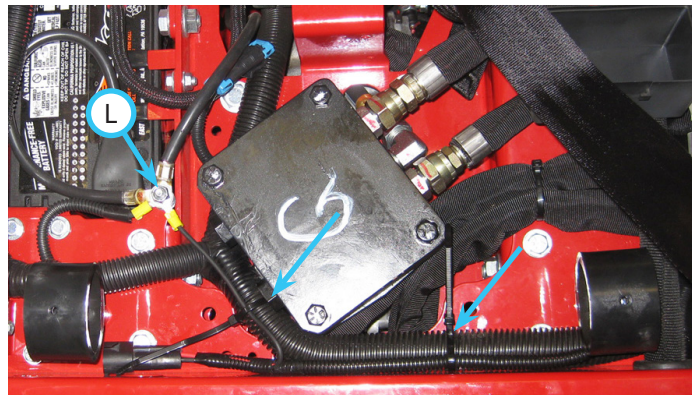

SETUP INSTRUCTIONS

31. **4500 and 4520 Serial # 01001-02172:** Use a needle nose pliers to remove the green plug (M) from position A2 (N - red highlighted position) on the rear fuse panel.

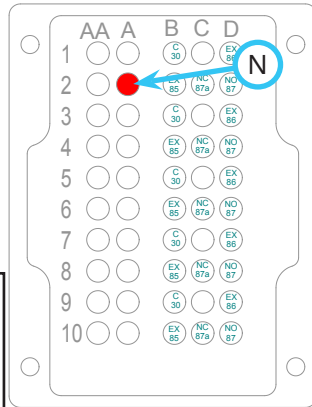
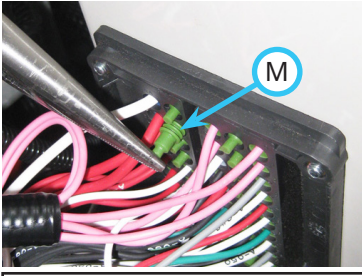

NOTE: Both the picture and the sketch are shown from the rear of the fuse panel inside the toolbox.

32. **4500 and 4520 Serial # 01001-02172:** Install the terminal into position A2 in the fuse panel. NOTE: the terminal can only be installed one way. Orient the terminal with the hole pointing up and insert into the fuse panel. The terminal needs to snap into place. If necessary, use a needle nose pliers to push the terminal in, being careful not to damage the wire insulation. Double check the connection by tugging gently on the wire with your hand.



33. **4520 Serial # 02173-:** Inside the right fender, use a small flat screwdriver to pry the seal (O) from position #10 (highlighted red) in the rear fuse panel.

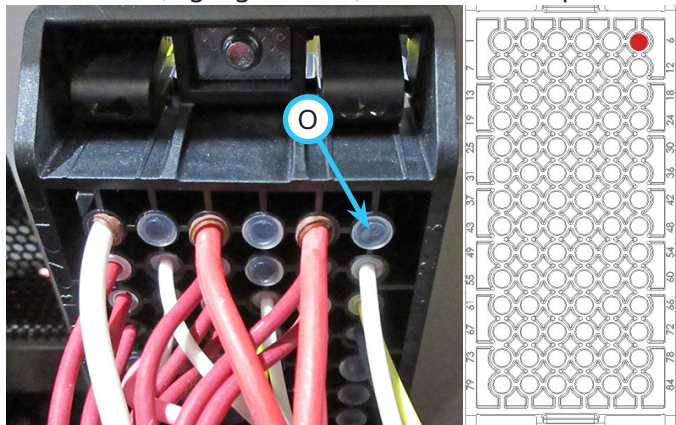

NOTE: the picture and diagram are shown from

- the back of the fuse panel inside the right fender.
34. **4520 Serial # 02173-:** Orient the terminal so the slot in the face is running side-to-side and install the terminal into position #6 in the fuse panel. The terminal needs to snap into place. If necessary, use a needle nose pliers to push the terminal in, being careful not to damage the wire insulation. Double check the connection by tugging gently on the wire with your hand.

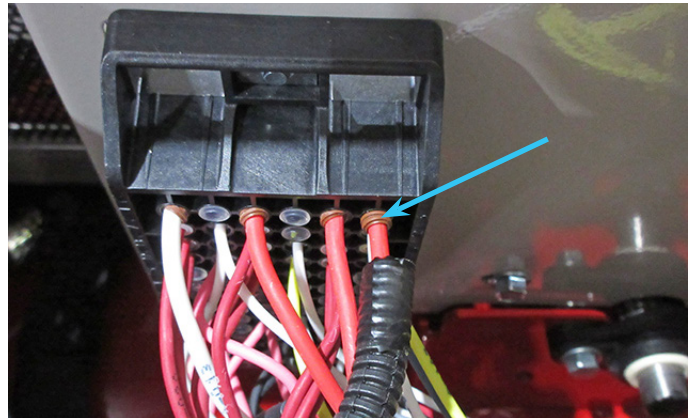

35. Tilt the seat forward as far as possible and secure in place.
36. Install a 16 inch length of 1/2 inch Velcro loop (40) onto the top flange on the front of the seat box frame.



37. Install two 8 inch lengths of 1 inch Velcro loop (44) onto the top flange on the rear of the seat box frame.
38. Remove the seat pin bolt and seat pin from the rear flange of the seat box.
39. Install the lower rear window mount (20) on the underside of the seat box rear flange using two 1/4 x 1/2 inch button head bolts (47) down through the outer holes in the seat box flange and the lower rear window mount and fasten with flange nuts.

SETUP INSTRUCTIONS



40. Fasten the center hole of the lower rear window mount using the seat pin and bolt.
41. Install the rear frame canvas onto the Velcro at the front of the seat box frame, stretch the canvas across the frame, and fasten onto the Velcro at the rear of the seat box frame. Make sure the seat springs stick up through the cutouts in the canvas.

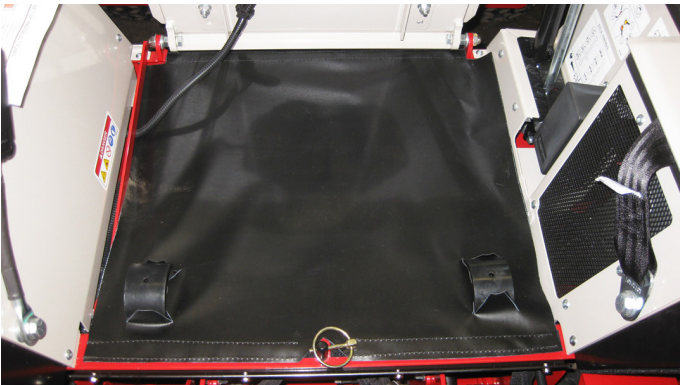

42. Remove the existing seat belt from the power unit. Install the seat belt upper mount (1) onto the back of the roll bar. Install two U-bolts from the front of the roll bar through the holes in the seat belt upper mount.



Center the seat belt upper mount on the top of the roll bar and fasten with four 3/8 inch locking flange nuts.

43. Make sure there are no twists in the seat belt and fasten the lower seat belt anchors to the power unit's seat box rear panels. Install a 7/16 x 1-1/4 inch bolt and flat washer through each seat belt anchor. Add two 7/16 inch flat washers between each seat belt anchor and the seat box rear panels. Fasten to the seat box rear panels with 7/16 inch flat washers and 7/16 inch lock nuts.
44. Install the toolbox liner panels [4500]. NOTE: do not install the two bolts that fasten the toolbox liners panels to the rear seat box panel.



45. [4500] Remove the two bolts (O) and nuts from the inside of the right rear fender and discard. Place the rear window right bracket (17) on the back side of the fender flange and fasten with two 1/4 x 3/4 inch button head bolts and 1/4 inch locking flange nuts.

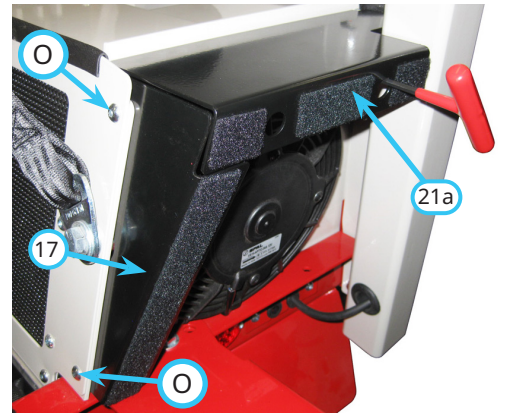

46. [4500] Install the rear window top bracket (21a) onto the rear panel above the cooler fan using two 1/4 x 3/4 inch button head bolts installed into the u-nuts on the toolbox liner panels.
47. [4520] Remove the seven bolts that fasten the top of the right fender cover (P) to the inner and outer right fender panels.

48. [4520] Install the rear window top bracket (21b) onto the rear panel above the cooler fan using two 1/4 x 3/4 inch button head bolts. Lift up slightly on the rear of the fender cover (P) to allow access to install two 1/4 inch flange nuts onto the bolts and tighten.

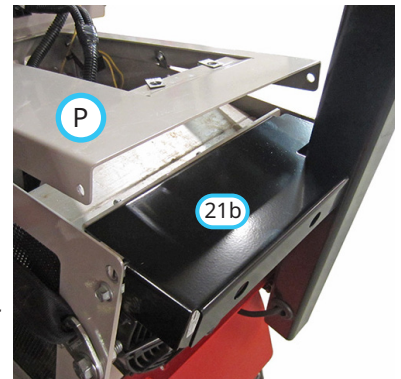

SETUP INSTRUCTIONS

49. **[4520]** Reinstall the seven bolts that fasten the top of the right fender cover to the inner and outer right fender panels.

50. **[4520]** Remove the two bolts (Q) from the inside of the right rear fender and discard the locking flange nuts. Place the rear window right bracket (17) on the back side of the fender flange and fasten with the original bolts and new 1/4 inch locking flange nuts.

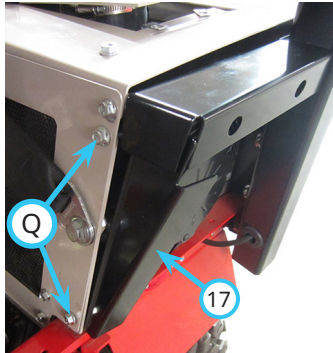

51. **[4500]** Remove the two bolts (R) and nuts from the inside of the left rear fender and discard. Place the rear window left bracket (23a) on the back side of the fender flange and fasten with two 1/4 x 3/4 inch button head bolts through the fender and into the u-nuts on the bracket.

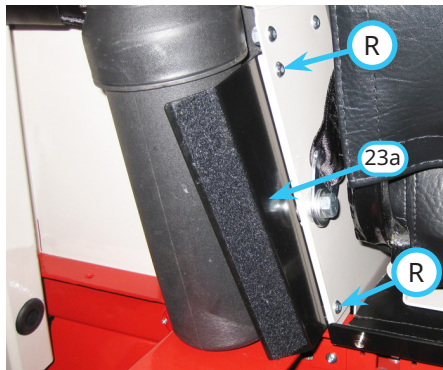

52. **[4520]** Remove the two bolts (S) from the inside of the left rear fender and discard the locking flange nuts. Place the rear window left bracket (23b) on the back side of the fender flange and fasten with the original bolts through the fender and into the u-nuts on the bracket.

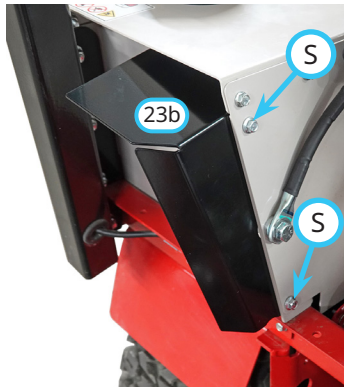

53. Install a 4 inch length of 1 inch Velcro loop (43) onto the underside of the fuel tank cover, between the roll bar and the manual holder **[4500]** or between the roll bar and the flange on the rear window left bracket **[4520]**.

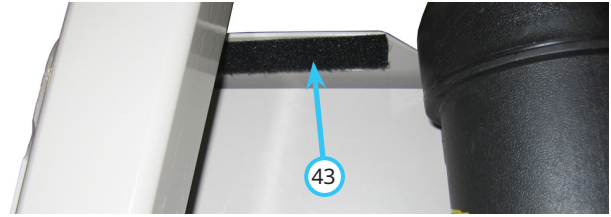

54. Identify the left and right rear cab mounts. The cab mounting surface will be angled forward toward the front and the upper hole in the roll bar mount will also be toward the front.

Upper mounting hole toward the front



55. Install the rear cab mounts onto the roll bar using two U-bolts and four 3/8 inch locking flange nuts. The bottom face of the mounting flange should be parallel (T) to the top face of the seat box panel and approximately 34 cm (13-3/8 inch) up from the bottom of the roll bar. NOTE: this distance may need to be adjusted up or down slightly if the holes in the rear brackets and glass on the lower right window and the lower door window do not align with the holes in the frame mount tabs or lower supports.



SETUP INSTRUCTIONS

56. Install a two piece isolator in the mounting hole of both rear cab mounts. Insert the stepped piece of the isolator down through the cab mount and install the bottom piece.

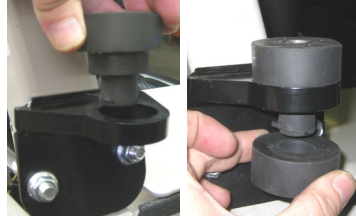

57. Place a 3/16 inch thick, notched washer (31) onto a 1/2 x 3 inch bolt. Insert the bolt through the isolator on the right cab front support (7). Install the right cab front support on the right front cab mount. Fasten with a 1/2 inch locking flange nut. Do not tighten.

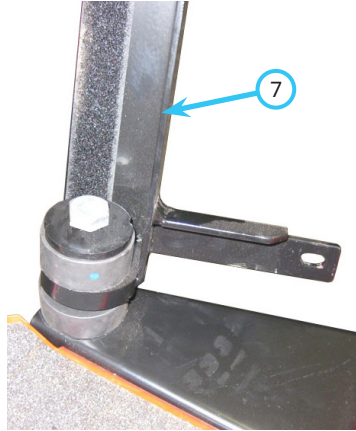

58. Repeat for the left cab front support (10).

59. Remove the gas door shock where it attaches to the cab frame. If the shock end is equipped with a spring clip (U), insert a flat screwdriver under the spring clip and pry down to release. If the shock end is equipped with a ring clip (V), pull on the ring until it releases from the shock end, then slide the clip toward the shock body to remove. Remove the shock end from the mounting stud.

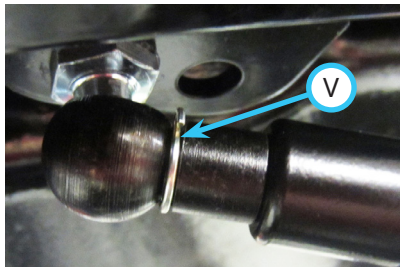
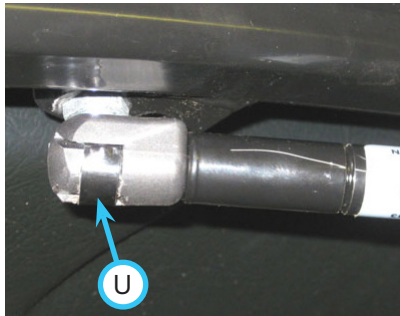

60. Remove the door from the cab by lifting it off the hinge pins.

61. Remove the right front window (emergency exit) and the right and left rear side windows. Lift up on the handle to unlatch and push to open the window. Pull the handle toward the rear of the cab until it can be removed from the latch pin.

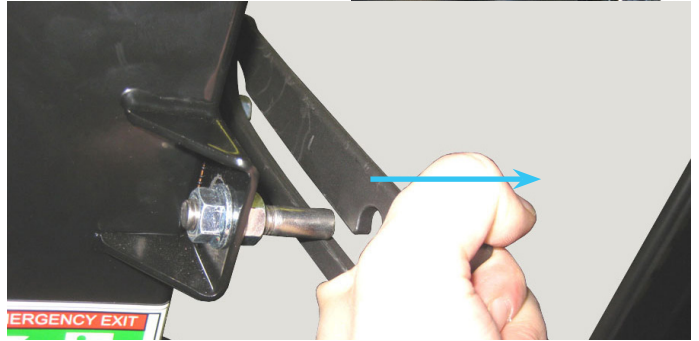

62. Remove the window from the cab by lifting the windows off the hinge pins.

63. Remove the fuel tank cover from the cab.

64. Install any desired cab accessories at this time.

65. Lift the weather cab and position it over the power unit.

⚠ WARNING

To lift the cab, use a Ventrac lift sling (part number 47.0381) attached to the four corner lift points or remove the cab roof and attach a lifting device with a minimum rating of 226 kg (500 lbs) to the two lift points inside the cab roof.

Never walk or stand beneath the cab when it is raised off the ground.

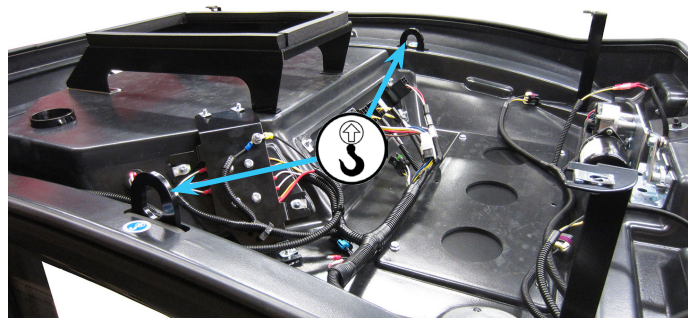

SETUP INSTRUCTIONS

66. Lower the cab onto the power unit. Insert a 1/2 x 3 inch bolt into the cab mount brackets and guide the bolts into the rear cab mount isolators.



67. Raise or lower the cab until the front cab supports align with the cab mounting holes (the cab supports mount on the inside of the mounting tabs on the cab frame). Install four 1/4 x 1 inch step bolts (49) and fasten with 1/4 inch flange nuts. Do not tighten.

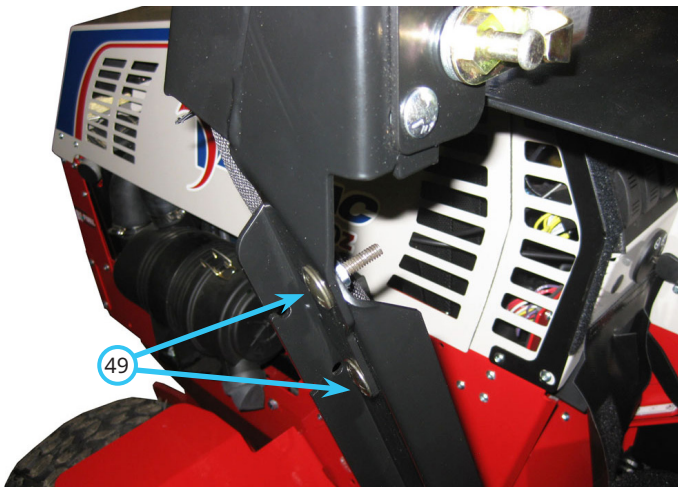

68. Lower the cab until the rear cab mount brackets are resting on the rear cab mount isolators. Install a 3/16 inch thick, notched washer (31) onto the 1/2 inch bolt on the bottom side of each rear cab mount isolator and fasten with 1/2 inch locking flange nuts.

69. Tighten the 1/4 inch hardware for the front cab supports to the cab and the 1/2 inch hardware at the four cab isolator mounts.

70. Install the fuel tank cover (5) by sliding the flanges down inside the mounting flanges on the cab. Press the fuel tank cover down far enough to seal against the top of the fuel tank. Install two 1/4 x 1/2 inch button head bolts through the front cab mounting flange and the front of the fuel tank cover and fasten with 1/4 inch flange nuts. Install

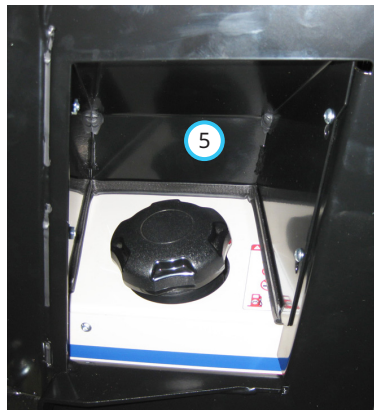

two 1/4 x 1/2 inch button head bolts through the rear holes in the fuel tank cover and the rear cab mounting flange and fasten with 1/4 inch flange nuts.

71. Install the door onto the cab by placing the hinge pivots onto the hinge pins on the cab.

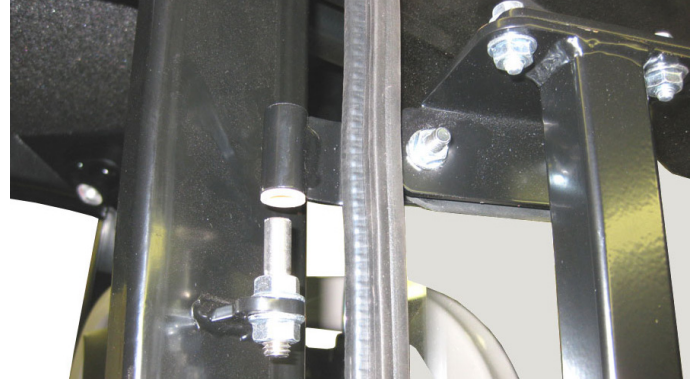

72. Install the gas door shock end onto the mounting stud on the cab frame. If the shock end is equipped with a spring clip, press the shock end onto the stud until the shock end snaps in place. If the shock end is equipped with a ring clip, place the shock end onto the mounting stud, insert the clip into the hole in the shock end, and snap the ring over the shock end to secure in place.

ATTENTION

The gas door shock must be installed to prevent the door from opening to far or swinging open or closed too fast. Damage to the door glass and/or weather cab glass may occur if the gas door shock is not installed.

73. Install the right lower window and right lower window bracket. Remove the nuts from the four step bolts installed in the window, but do not remove the spacers. Insert the bolts into the three mounting tabs (W, X, and Y) on the cab frame. Install the right lower window bracket (14) onto the three rear step bolts (X, Y, and Z) and fasten all four bolts with the 1/4 inch flange nuts. Tighten only

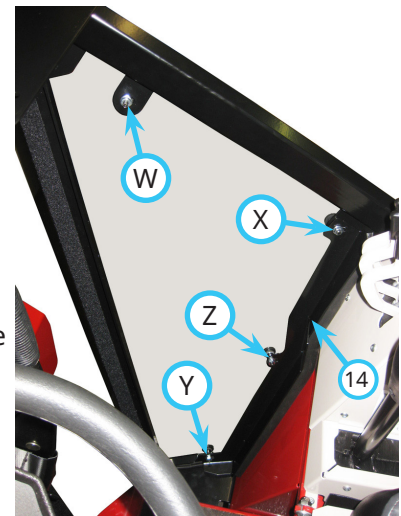

SETUP INSTRUCTIONS

until the rubber washers under the step bolt heads begin to bulge slightly.

74. Install the lower door window support (18) to the door frame with two 5/16 x 3/4 inch bolts (50) and flat washers. Fasten with two 5/16 inch locking flange nuts and tighten until snug but the support can still be moved.

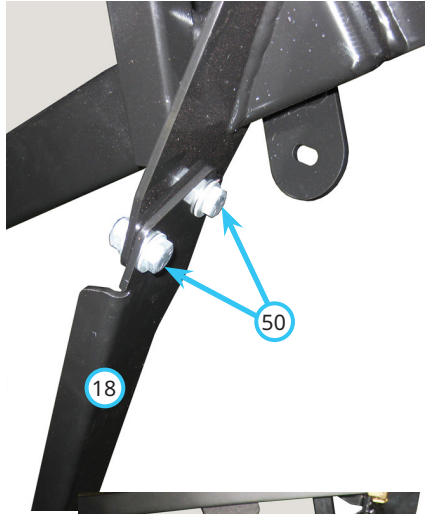

75. Install the lower door window and the lower door window bracket (19). Remove the nuts from the four step bolts installed in the window, but do not remove the spacers. Insert the bolts into the two mounting tabs (a and b) on the door frame and the mounting hole (c) on the lower door window support (18). Install a 1/4 inch flange nut on the top front bolt (a) to hold the window in place.

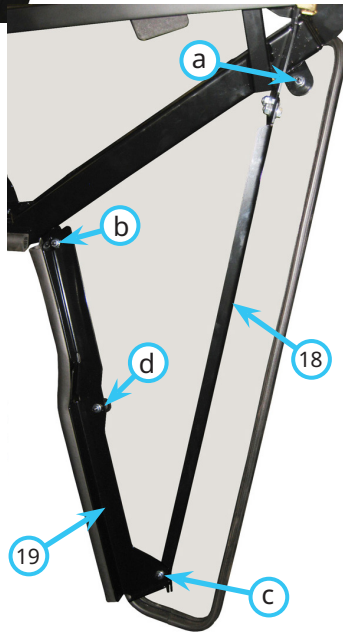

Install the lower door window bracket (19) on the three rear step bolts (b, c, and d) and fasten with 1/4 inch flange nuts. Tighten all four flange nuts only until the rubber washers under the step bolt heads begin to bulge slightly.

76. Close the cab door and check the seal of the lower window to the power unit and cab. Move the bottom of the lower door window support in or out until the window seals properly. Tighten the 5/16 x 3/4 inch bolts at the top of the lower door window support. NOTE: if door latch adjustment is required, refer to the service section of this manual.

77. Install the left column canvas (25) onto the left side of the front frame column. Fasten the Velcro to the dash panel (e), the frame plate (f), and the flange on the pump cover (g).

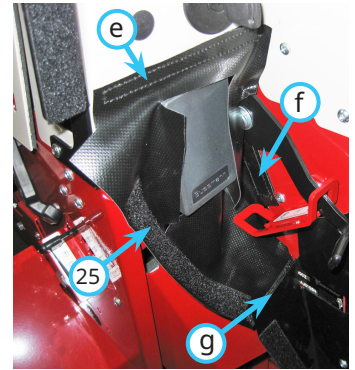

78. Install the right column canvas (24) onto the right side of the front frame column. Fasten the Velcro to the parking brake cover (h and i) and the flange on the pump cover (j).

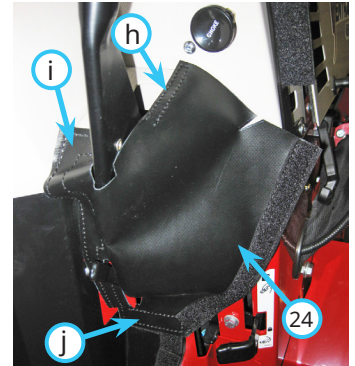

79. Lay out the canvas bellows with the Velcro on the triangular windows facing down. Identify the left (9) and right (8) bellows as shown.

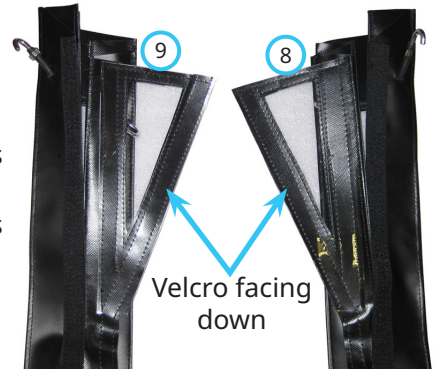

80. Install a bellows support strap through both the top and bottom sets of holes in the left and right canvas bellows.

81. Hook the top bellows support straps to the left and right cab front supports (k) and the left and right canvas column mounts (l). Hook the bottom bellows support straps to the left and right cab front supports (m) and the left and right flanges of the pump cover (n).

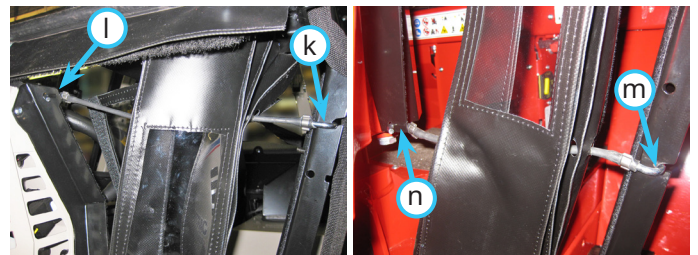

SETUP INSTRUCTIONS

82. Fasten the outer Velcro strips on the canvas bellows to the Velcro strips on the left and right cab front supports (o). Fasten the Velcro strips on the triangular windows to the Velcro strips on the left and right canvas column mounts (p). Fasten the inner Velcro strips on the canvas bellows to the Velcro strips on the pump cover and the left and right column canvas (q).



83. [4500] Remove the left blank cover from the back of the seat box frame, route the wire harness through the cutout, and connect to the wire harness installed earlier.
84. [4500] Cut one of the grommets in the kit and place over the wire harness. Install the grommet into the access cover (27a) and install the access cover onto the seat box frame.

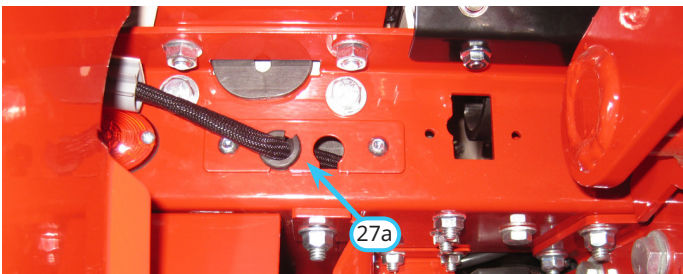

85. [4520] Remove the cover (r) from the back of the seat box frame.

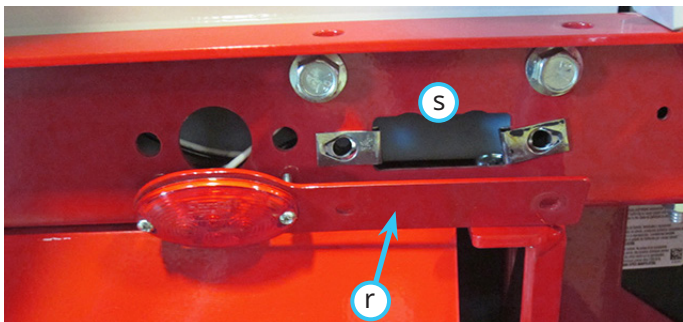

86. [4520] Disconnect the tail light from the wire harness. If necessary, the harness and light connectors can be pulled out through the rectangular cutout in order to disconnect. **NOTE:** if the cover has a slotted mounting hole, the light can be removed without disconnecting the wire harness.

87. [4520] Remove the tail light from the blank cover and reinstall onto the included access cover (27b).

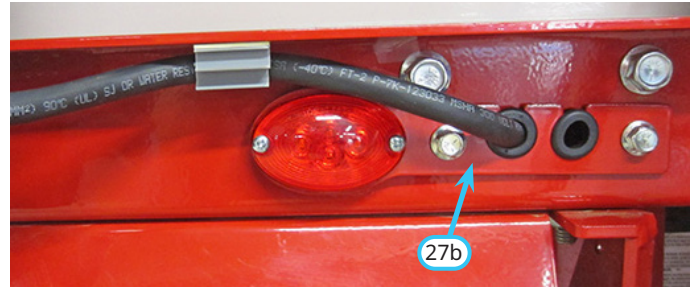

88. [4520] Reconnect the tail light to the power unit wire harness.
89. [4520] Route the wire harness through the cutout, and connect to the wire harness installed earlier.
90. [4520] Cut one of the grommets in the kit and place over the wire harness. Install the grommet into the access cover (27b) and install the access cover onto the seat box frame.

ATTENTION

Prior to the installation of the adhesive clamps, clean the area thoroughly with alcohol wipes or other cleaning wipes that will not leave residue.

91. Install one adhesive clamp (30) onto the bottom of the seat box frame above the tail light. Install the other clamp (30) onto the roll bar about halfway between the seat box frame and the cab frame.

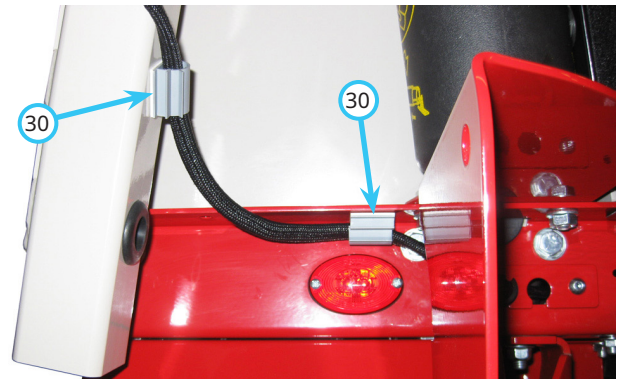

SETUP INSTRUCTIONS

92. Snap the lower rear canvas window into place on the cab frame and the lower rear window mount. Attach the Velcro strips on the window to the Velcro strips on the rear window brackets, the underside of the fuel tank cover, and the cab frame.

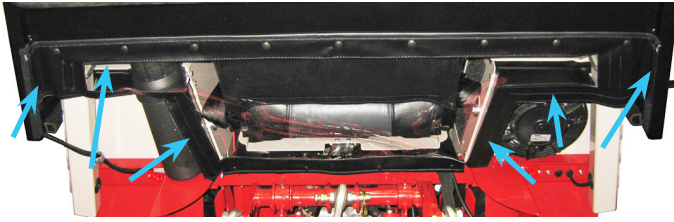

93. Install the right front window and the left and right rear side windows by placing the hinge pivots on the windows onto the hinge pins on the cab frame. Place the latches over the latch pins and push down to latch the windows.
94. **4500 and 4520 Serial # 01001-02172:** Install the 30 amp circuit breaker into position F02 in the rear fuse panel and reinstall the fuse panel cover. NOTE: if a strobe light kit was installed previously, this position will already have a fuse installed.

4500 - All Units
4520 Serial # 01001-02172

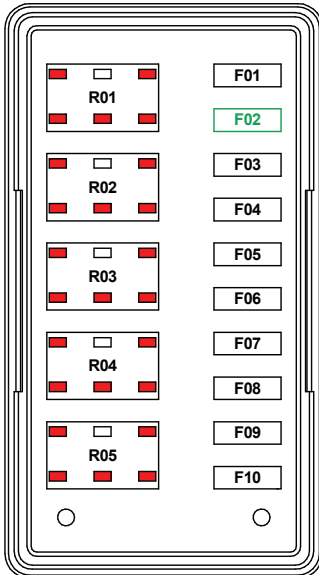

4520 Serial # 02173-05664

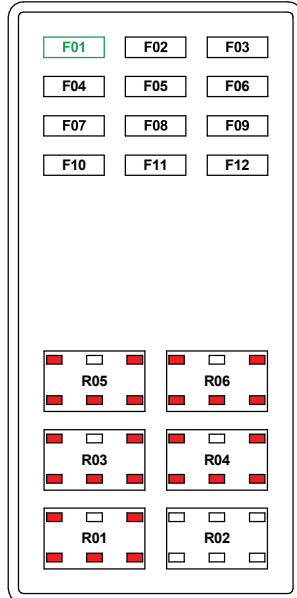

- 4520 Serial # 02173-05664:** Install the 30 amp circuit breaker into position F01 in the rear fuse panel and reinstall the fuse panel cover. NOTE: if a strobe light kit was installed previously, this position will already have a fuse installed.

- 4520 Serial # 05665-:** Install the 30 amp circuit breaker into position F01 in the rear fuse panel and reinstall the fuse panel cover. NOTE: if a weather cab was installed previously, this position may already have a circuit breaker installed.

4520 Serial # 05665-

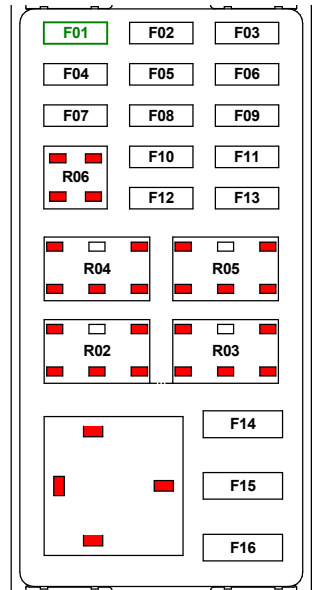

ATTENTION

Do not exceed 30 amp draw to the weather cab and additional accessories.

95. Determine whether the power unit is equipped with a gasoline or a diesel engine, and install the appropriate gasoline safety decal (33) or diesel safety decal (34) onto the cab frame next to the fuel tank cover.
96. Check the power unit's tire pressure and adjust if necessary. Refer to the service chapter of this manual for recommended tire pressures with the weather cab installed.
97. Connect the negative battery cable to the battery.
98. Installation is complete. For weather cab removal instructions, refer to the Preparing the Weather Cab for Storage section in the service chapter.



OPERATIONAL CONTROLS

Operational Control Locations

These images identify the locations of the controls. Become familiar with all the controls before operating the machine.

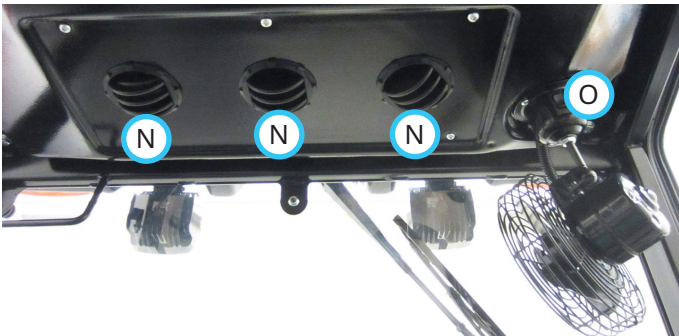
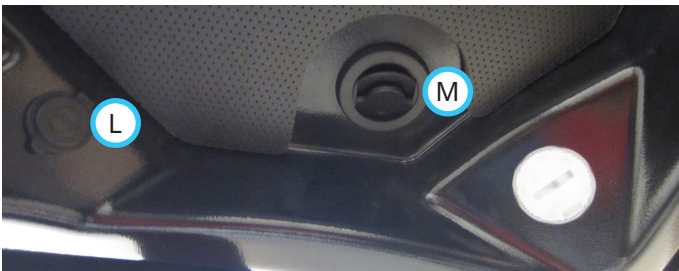
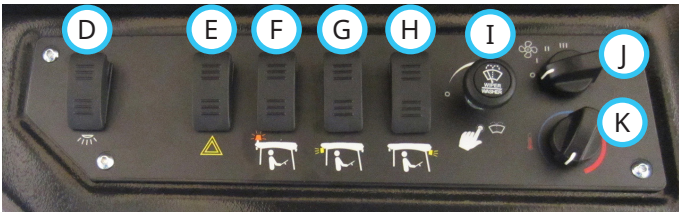
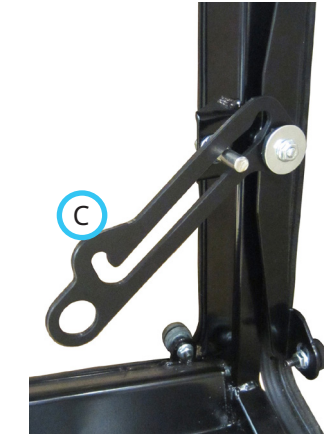
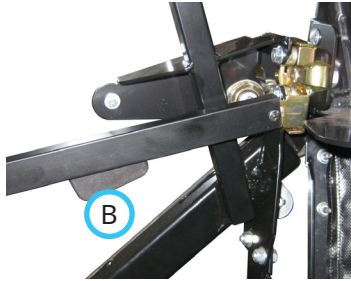
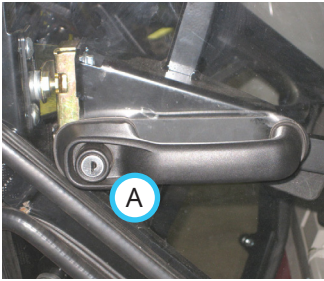

- A. Outer Door Handle and Lock
- B. Inner Door Handle
- C. Window Latch Handle
- D. Interior Light Switch
- E. Hazard Light Switch (Optional)
- F. Strobe Light Switch (Optional)
- G. Rear Work Light Switch
- H. Front Work Light Switch
- I. Windshield Wiper / Washer Switch
- J. Heater Fan Speed Switch
- K. Heater Temperature Switch
- L. USB Receptacle
- M. Rear Heater Vent
- N. Main Heater Vents
- O. Defrost Fan and Switch (Optional)

Outer Door Handle and Lock (A)

Push the button on the outer door handle to unlatch the door. The outer door handle can be locked with a key. Turn the key clockwise to lock and counterclockwise to unlock the door.

Inner Door Handle (B)

Squeeze the button on the inner door handle to unlatch the door. The door cannot be locked from the inside.

Window Latch Handle (C)

The side windows of the weather cab can be opened and latched in place. Raise the window latch handle, push out on the window, and lower the handle to latch in place. When the window is open, the latch handle can be pulled away and removed from the latch pin. This allows the right front window to be opened fully for use as an emergency exit and allows the side windows to be removed from the weather cab.

Interior Light Switch (D)

Pressing the top portion of the interior light switch turns on the interior light located in the right rear corner of the headliner. Pressing the bottom portion of the switch turns the light off.

Hazard Light Switch (E)

Optional accessory. Pressing the top portion of the hazard light switch flashes four hazard lights on the weather cab corners. Pressing the bottom portion of the switch turns the hazard lights off.

OPERATIONAL CONTROLS

Strobe Light Switch (F)

Optional accessory. Pressing the top portion of the strobe light switch turns on the strobe light mounted at the left rear corner of the weather cab. Pressing the bottom portion of the switch turns the strobe light off.

The strobe light has six different flasher modes that can be selected. Refer to the service section of this manual for instructions on changing the strobe light flasher mode.

Rear Work Light Switch (G)

Pressing the top portion of the rear work light switch turns on the rear work light. Pressing the bottom portion of the switch turns the work light off.

Front Work Light Switch (H)

Pressing the top portion of the front work light switch turns on the front work lights. Pressing the bottom portion of the switch turns the work lights off.

Windshield Wiper / Washer Switch (I)

The windshield wiper switch is equipped with an intermittent (variable delay) position and two fixed speed positions. The fixed speed positions are both set to run the wiper motor at the same speed.

Rotate the windshield wiper switch clockwise to turn on the windshield wiper. Continue rotating the switch clockwise until it clicks to select the fixed speed position.

Between the off and fixed positions is the intermittent position that sets the wiper speed to a long or short interval between wiper cycles. Rotate the switch clockwise for a shorter interval. Rotate the switch counterclockwise for a longer interval.

Heater Fan Speed Switch (J)

Rotate the heater fan speed switch to select the desired fan speed position - Off, Low, Medium, or High.

Heater Temperature Switch (K)

The temperature switch controls the air temperature from the heater. Rotate the switch clockwise for warmer air. Rotate the switch counterclockwise for cooler air.

USB Receptacle (L)

The USB receptacle has two USB ports for charging phones or other accessories.

Rear Heater Vent (M)

The rear heater vent can be rotated and the louvers tilted to direct airflow in the desired direction.

Do not rotate the vent by the louvers. Use the vent flange to rotate the vent.

Main Heater Vents (N)

The main heater vents can be rotated and the louvers tilted to direct airflow in the desired direction.

Do not rotate the vents by the louvers. Use the vent flange to rotate the vents.

Defrost Fan and Switch (O)

Optional accessory. The defrost fan has two speeds. Pressing the top portion of the switch turns the fan on low speed. Pressing the bottom portion of the switch turns the fan on high speed. Return the switch to the middle position to turn the fan off. The fan can be turned to direct the air where needed.

GENERAL OPERATION

Daily Inspection

⚠ WARNING

Always engage the parking brake, shut off the power unit engine, remove the ignition key, and ensure that all moving parts have come to a complete stop before inspecting the components, or attempting any repair or adjustment.

1. Park the machine on a level surface, with the engine shut off and all fluids cold.
2. Perform a visual inspection of both the power unit and the weather cab. Ensure the weather cab is properly mounted to the power unit. Look for loose or missing hardware, damaged components, or signs of wear.
3. Check the work lights, hazard lights, and/or strobe lights to ensure the lights are working properly.
4. Inspect the window and door seals for cracks and tears. Check glass for chips or damage.
5. Inspect the heater hoses (if equipped) to ensure tight, leak free connections.

ATTENTION

If the weather cab is equipped with a heater kit and the outside air temperature is 4° C (40° F) or above, the radiator baffle must be removed and replaced with the radiator screen.

6. Check the windshield wiper blade condition. Clear any ice or snow from the wiper blade before use. If the blade is frozen to the windshield, carefully loosen or thaw the wiper blade.
7. Clear any ice or snow from the windows and/or defrost the windows before operation. Do not operate if visibility is restricted.

4-Point Seat Belt

Fasten the lower buckle (A) of the 4-point seat belt and adjust the lap belt until snug but not tight. Tighten by pulling on the ends of the lap belt straps. Tighten both sides evenly so the buckle remains centered on the operator. Loosen by pulling up on the edge of the seat belt strap lock facing away from the buckle.

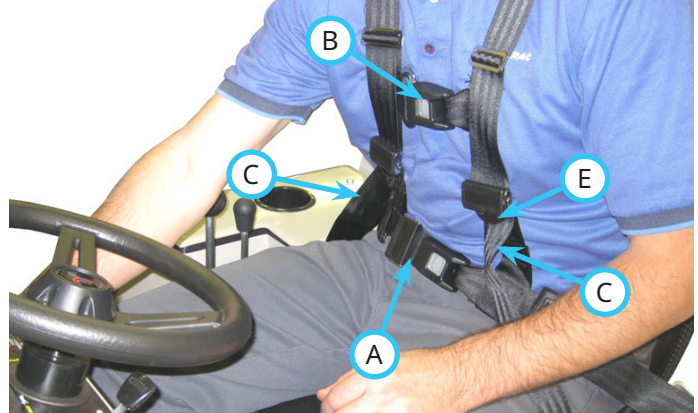

Fasten the upper buckle (B) of the 4-point seat belt and adjust the left and right shoulder belts. The shoulder belts should be loose enough to allow the operator to reach all dash controls, but should be snug at the point that the operator can reach the dash controls. Tighten the left and right shoulder belts (C) by pulling on the ends of the straps. Loosen the shoulder belts by lifting up on the tab (E) on the seat belt strap lock

Adjust the upper buckle location so that the buckle catches the operator in the middle of the chest when the operator leans forward against the belt.

If the seat belt cannot be tightened or loosened far enough to properly fit the operator, the seat belt upper mount will need to be adjusted. Refer to the Seat Belt Upper Mount Adjustment section in the service chapter of this manual.

Strobe Light

The strobe light is mounted on a pivoting arm. Rotate the strobe light up during operation. Rotate the strobe light back and down for low clearance areas, transport, or storage.

The strobe light arm is held in place by a spring. If the strobe light or arm contacts an object, the spring releases the pivot arm to rotate either forward or backward away from the object. If this occurs, stop operation and return the strobe light to the operating position when clearance allows.

SERVICE

ATTENTION

If any component requires replacement, use only original Ventrac replacement parts.

Cleaning and General Maintenance

For best results, and to maintain the finish of the weather cab, clean or wash the weather cab after each use to remove dirt, gravel, and salt deposits. Remove any ice and snow accumulations from the roof, windows, and accessories.

ATTENTION

To maintain the finish of the weather cab and accessories, thoroughly wash the equipment after each use to remove any corrosive agents (e.g., salt). Failure to clean the equipment may result in corrosion of (including but not limited to) steel, aluminum, and electrical components. Equipment that will experience repeated exposure to corrosive agents should be pretreated with a corrosion preventative.

Seat Belt Upper Mount Adjustment

The seat belt upper mount has four seat belt mounting positions. The seat belt is mounted in the second position at the factory.

If the seat belt cannot be tightened enough to properly secure the operator, move the seat belt anchors to the first position on the seat belt upper mount.

If the seat belt cannot be loosened enough to fit the operator, move the seat belt anchors down to the third or fourth position on the seat belt upper mount.

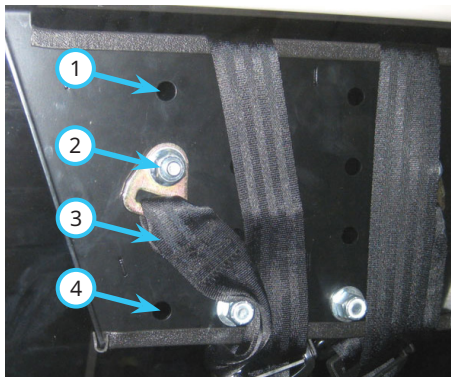

Window Latch Adjustment

The window latch pins can be adjusted if the windows do not close properly.

If the window does not seal correctly, loosen the nut on the window latch pin and move away from the window slightly.

If the window latch is hard to close, move the window latch pin toward the window slightly.

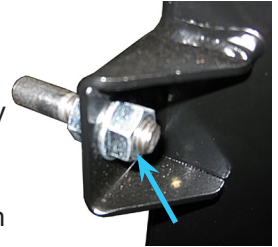

Window Latch Handle Adjustment

If the window latch handle is not properly positioned when latched (to close to the glass or sticks out too far from the glass), the window latch handle position can be adjusted. Unlatch the handle, loosen the handle bolt (A), and move the handle up or down in the mounting slot. Moving the handle up will position the handle closer to the glass when latched. Moving the handle down will position the handle farther from the glass when latched.

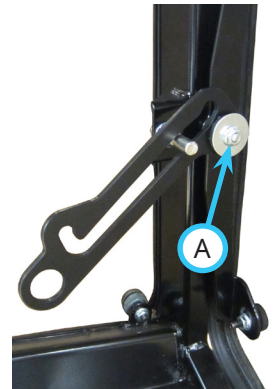

Door Latch Adjustment

If the door does not latch properly, the latch pin can be adjusted. If the latch pin and door latch are misaligned vertically, loosen the nut on the back of the latch pin (A) and move the latch pin up or down until it is properly aligned with the door latch.

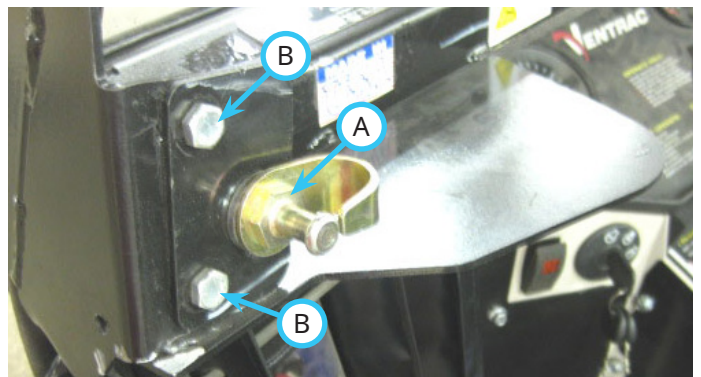

If the door does not latch because the latch pin is set too deep or if the door latches but does not seal properly, loosen the two latch plate bolts (B) and move the latch plate in or out to the proper depth. NOTE: Check the lower door window for proper adjustment prior to changing the latch pin depth.

SERVICE

Door Latch Lubrication

Lubricate the door latch mechanism every 50 hours with a spray lubricant or light weight oil. Use a cloth to protect the window glass from over spray and wipe off any excess lubricant to prevent dripping.

Lower Door Window Adjustment

Check the bottom of the lower door window where it meets the left cab front support.

If there is a gap between the lower door window and the cab front support when the main door is closed and sealed, the lower door window needs to be adjusted inward.

If the lower door window hits the cab front support too soon, it can prevent the cab door from latching or sealing properly. If this is the case, the lower door window needs to be adjusted outward.

Loosen the two bolts (A) at the top of the lower door window support (B). Move the bottom of the lower door window in or out until the proper position is reached. Retighten the bolts on the lower door window support.

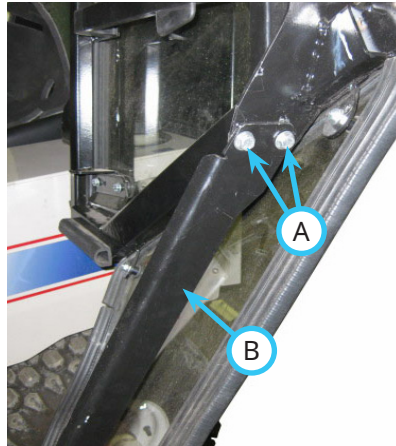

Fuse Replacement

The fuse panel is located in the headliner to the right of the main control panel.

1. Remove the two thumb screws (A) from the fuse panel cover (B).

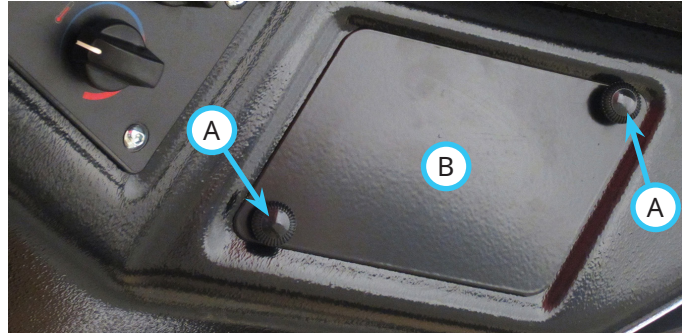

2. Remove the defective fuse from the socket.

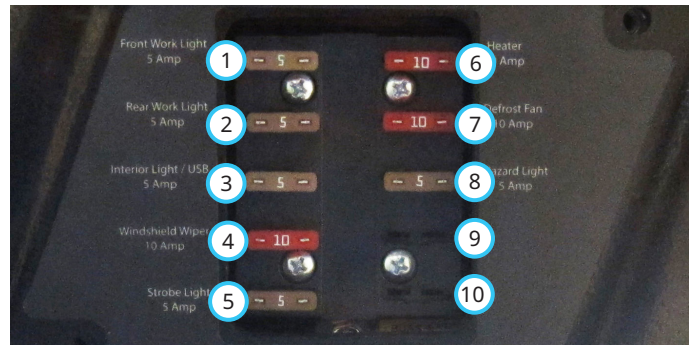

Position	Fuse	Circuit
1	5 amp	Front Work Lights
2	5 amp	Rear Work Light
3	5 amp	Interior Light / USB Outlet
4	10 amp	Windshield Wiper / Washer
5*	5 amp	Strobe Light
6	10 amp	Heater
7*	10 amp	Defrost Fan
8*	5 amp	Hazard Lights
9	-	Open
10	-	Open

*Optional accessory

3. Insert a new fuse into the socket. Be sure the fuse is the correct amperage or damage may occur to the electrical system.
4. Reinstall the fuse panel cover and thumb screws.

SERVICE

Wiper Blade Replacement

The wiper blade should be replaced on a yearly basis, or sooner if the blade becomes damaged or does not clean the windshield effectively.

1. Remove the nut (A) and bolt that fasten the wiper blade to the wiper arm.

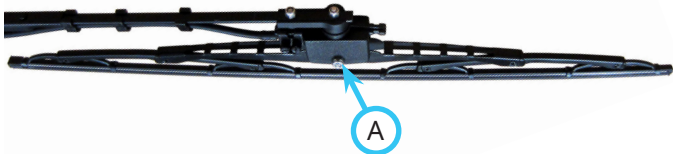

2. Install a new wiper blade and fasten with the nut and bolt.

Windshield Washer Nozzle Inspection and Adjustment

There are four windshield washer nozzles (A), two on each side of the wiper arm. The two lower nozzles (B) should be aimed so the washer fluid sprays straight at the glass or slightly down. The two upper nozzles (C) should be aimed so the washer fluid wets the glass at the top edge of the wiper blade.

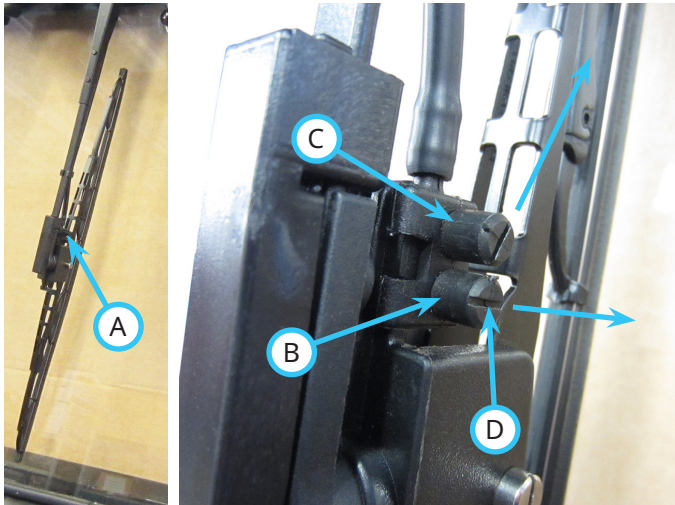

If necessary, adjust the spray nozzles using a flat blade screwdriver in the nozzle adjustment slots (D). The adjustment slots align with the nozzle spray direction and can be used to aim the nozzles when making adjustments.

Changing the Strobe Light Flasher Mode

1. Remove the roof from the top of the cab.
2. Locate the wires from the strobe light where they connect to the main wire harness. The yellow wire is used to cycle the strobe light modes.
3. Turn the power unit ignition key to the On position to send power to the cab.
4. Turn the strobe light switch to the on position.
5. Insert the bare end of the yellow wire into the back of the terminal on the red power supply wire. Each time you touch the yellow wire against the red wire, the strobe light will change modes.
6. When the desired mode is reached, turn off the strobe light, turn the power unit ignition key to the Off position, and reinstall the cab roof.

Strobe Light Pin Lubrication

Apply a thin film of grease to the pin (A) on the spring latch arm every 50 hours of operation.

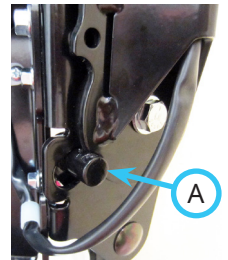

SERVICE

Heater Air Filter Replacement

The heater air intake filter should be replaced on a yearly basis, or sooner if operating in dusty conditions.

1. Remove the two thumb screws (A) holding the filter cover (B) onto the cab.

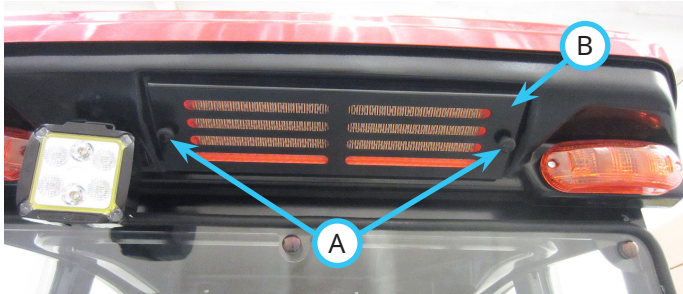

2. Remove the air filter (C) from the cab air intake vent and insert the replacement filter.



3. Reinstall the filter cover and fasten with the thumb screws.

Storage

Preparing the Weather Cab for Storage

1. Clean the weather cab.

ATTENTION

To maintain the finish of the power unit and the weather cab, thoroughly wash the equipment to remove any corrosive agents (e.g., salt). Failure to clean the equipment may result in corrosion of (including but not limited to) steel, aluminum, and electrical components.

2. Inspect for loose or missing hardware, damaged components, or signs of wear. Repair or replace any damaged or worn components.
3. Inspect the safety decals. Replace any decals that are faded, illegible, or missing.

Removing the Weather Cab

⚠ WARNING

Engage the parking brake, shut off the power unit engine, remove the ignition key, and ensure that all moving parts have come to a complete stop before starting installation or attempting any repair or adjustment.

Always disconnect the negative battery cable from the battery when working with electrical components.

⚠ WARNING

Safety glasses must be worn during installation.

Hearing protection must be worn when using air or power tools.

⚠ WARNING

To lift the cab, use a Ventrac lift sling (part number 47.0381) attached to the four corner lift points or remove the cab roof and attach a lifting device with a minimum rating of 226 kg (500 lbs) to the two lift points inside the cab roof.

Never walk or stand beneath the cab when it is raised off the ground.

⚠ WARNING

Place wheel chocks in front and back of the wheels to prevent the power unit from moving during setup of the power unit and weather cab.

1. Place wheel chocks in front and back of the wheels to prevent the power unit from moving.
2. If the weather cab is equipped with a heater kit, locate the connection of the left cab heater hose and the power unit heater hose at the front edge of the power unit foot platform. Pinch the hoses on each side of the connection to prevent loss of fluid. Disconnect the heater hoses and cap the ends with the fittings provided with the heater kit.
3. Repeat for right side heater hoses.
4. Unsnap and remove the lower rear canvas window.
5. Disconnect the cab wire harness under the power unit seat. Remove the access cover from the back of the seat box frame and remove the harness from the power unit. Reinstall the access cover. Remove the harness from the wire clamps on the seat box frame and the roll bar.

SERVICE

6. Remove the rear frame canvas from under the seat.
7. Unhook the 4) bellows support straps from the cab front supports and column mounts. Remove the canvas bellows with the support straps from the weather cab.
8. Remove the left column canvas from around the high/low shift lever.
9. Remove the right column canvas from around the parking brake and the neutral assist lever.
10. Remove the cab door, the right front emergency window, and the left and right rear windows.
11. Remove the right lower window and window bracket from the weather cab.
12. Remove the 1/2 inch bolts from the rear cab mounts .
13. Loosen the 1/4 inch step bolts that fasten the main cab frame to the front cab supports.
14. Attach the lift sling or other lifting device to the cab, adjust the tension to support the cab, and remove the 1/4 inch step bolts from the front cab supports.

WARNING

To lift the cab, use a Ventrac lift sling (part number 47.0381) attached to the four corner lift points or remove the cab roof and attach a lifting device with a minimum rating of 226 kg (500 lbs) to the two lift points inside the cab roof.

Never walk or stand beneath the cab when it is raised off the ground.

15. Lift the weather cab and remove it from the power unit.
16. Place the weather cab on a pallet for storage.
17. Remove the rear cab mounts from the power unit roll bar and store with the cab.
18. Loosen the 1/2 inch bolts that fasten the front cab supports to the front cab mounts, but do not remove. Remove the front cab mounts from the power unit foot platform and store with the cab.
19. Remove the pump cover with flanges from the power unit center column and reinstall the original pump cover.
20. Remove the left and right canvas column mounts from the power unit dash.
21. Remove the left, right, and top window brackets from the rear of the power unit.
22. Move the power unit steering cylinder to the middle mounting hole if using dual wheels or move to the inner hole for use with single wheels.

23. Reinstall the right and left foot pegs, if desired.
24. The 4-point seat belt may be left installed for use without the weather cab.

WARNING

If the 4-point seat belt is removed from the power unit, the original lap belt must be reinstalled.

25. Place all cab components that were removed from the cab and power unit on the pallet inside the weather cab.
26. Reinstall the right emergency window and the right and left rear windows onto the cab.
27. Place the door inside the cab for storage, or remove the lower door window, the window support, and the lower door support bracket and place inside the cab and reinstall upper door onto the cab.
28. Secure the cab to the pallet and store at a location where it is protected from damage.

Removing the Weather Cab from Storage

1. Clean the attachment to remove any accumulated dust or debris.
2. Install the weather cab on the power unit following the setup instructions in this manual.
3. Inspect the weather cab as instructed in the Daily Inspection section of this manual.
4. Test the weather cab to ensure that all the components are working properly.

Power Unit Tire Pressure

With a weather cab installed, the power unit tire pressure should be maintained at 83-110 kPa (12-16 PSI) for all-terrain tires and for bar tires or at 103-138 kPa (15-20 PSI) for turf tires.

SPECIFICATIONS

Dimensions

Overall Height188 cm (74 inches)
Overall Length150 cm (59 inches)
Overall Width127 cm (50 inches)
Weight	188 kg (415 pounds)
Height (installed on power unit)206 cm (81 inches)
Height with Strobe Beacon (installed on power unit)219 cm (86 inches)
Length (installed on power unit w/standard hitch).234 cm (92 inches)
Turning Radius (cab installed on power unit)173 cm (68 inches)

Features

- Glass on frame design
- Tempered glass
- Removable door and side windows
- Emergency exit
- Window in the lower rear panel
- Windows in the front pleated canvas panels
- Contoured headliner and roof assembly
- Heavy duty front wiper and wiper motor
- Front and rear LED work lights
- 4 point seat belt
- Cushioned headrest
- Dual port USB outlet