



# Operator's Manual

# ND540

Snow Plow

Serial Number ND540-AB01107 --





500 Venture Drive  
Orrville, OH 44667  
www.ventrac.com

View all manuals



Visit [ventrac.com/manuals](http://ventrac.com/manuals) for the latest version of this operator's manual.

A downloadable parts manual is also available.

### To the Owner Contact Information and Product Identification

If you need to contact an authorized Ventrac dealer for information on servicing your product, always provide the product model and serial numbers.

Please fill in the following information for future reference. See the picture(s) below to find the location of the identification numbers. Record them in the spaces provided.

Date of Purchase: \_\_\_\_\_

Dealer: \_\_\_\_\_

Dealer Address: \_\_\_\_\_

Dealer Phone Number: \_\_\_\_\_

Dealer Fax Number: \_\_\_\_\_

Model # (A): \_\_\_\_\_

Serial # (B): \_\_\_\_\_



Venture Products Inc. reserves the right to make changes in design or specifications without obligation to make like changes on previously manufactured products.

# TABLE OF CONTENTS

<b>INTRODUCTION</b>	<b>PAGE 4</b>
Product Description . . . . .	4
Why Do I Need an Operator’s Manual? . . . . .	4
Using Your Manual . . . . .	5
Manual Glossary . . . . .	5
<b>SAFETY</b>	<b>PAGE 6</b>
General Safety Procedures . . . . .	6
Training Required . . . . .	6
Requirements for Personal Protective Equipment (PPE) . . . . .	6
Operation Safety. . . . .	6
Keep Riders Off . . . . .	8
Operating On Slopes . . . . .	8
Roadway Safety . . . . .	8
Truck Or Trailer Transport . . . . .	9
Maintenance . . . . .	9
Fuel Safety . . . . .	10
Hydraulic Safety . . . . .	11
Safety Decals. . . . .	13
<b>OPERATIONAL CONTROLS</b>	<b>PAGE 14</b>
Plow Blade Angle . . . . .	14
<b>GENERAL OPERATION</b>	<b>PAGE 15</b>
Daily Inspection . . . . .	15
Attaching . . . . .	15
Detaching. . . . .	15
Operating Procedure . . . . .	15
Transport of the Attachment. . . . .	16
Resetting the Blade Safety Trip . . . . .	16
Skid Shoe Adjustment. . . . .	16
<b>SERVICE</b>	<b>PAGE 17</b>
Cleaning and General Maintenance. . . . .	17
Cutting Edge Reversal/Replacement . . . . .	17
Skid Shoe Replacement. . . . .	17
Optional Polyurethane Cutting Edge Adjustment/Reversal . . . . .	17
Lubrication Locations . . . . .	18
Storage . . . . .	18
Maintenance Schedule . . . . .	19
Maintenance Checklist . . . . .	19
<b>SPECIFICATIONS</b>	<b>PAGE 20</b>
Dimensions. . . . .	20
Features. . . . .	20

# INTRODUCTION



Venture Products Inc. is pleased to provide you with your new Ventrac snow plow! We hope that Ventrac equipment will provide you with a ONE Tractor Solution.

Accessories	Item Description	Part Number
	Polyurethane Cutting Edge Kit	70.8190

## Product Description

The Ventrac ND540 snow plow is designed solely for the purpose of snow removal from sidewalks and other small areas that are difficult to reach or clear with large equipment.

The snow plow has a working width of 137 cm (54 inches) and can be angled 30 degrees in either direction. The snow plow is raised, lowered, and angled using the power unit's hydraulic control lever.

Adjustable skid shoes allow the plow height to be adjusted to match cutting edge wear and surface conditions.

## Why Do I Need an Operator's Manual?

This manual has been created to help you gain the important knowledge of what is needed to safely operate and maintain your machine, and to avoid injury and product damage. It is divided into chapters for convenient reference of the appropriate information.

You must read and understand the operator's manual for each piece of Ventrac equipment you own. Reading the operator's manual will help you become familiar with each specific piece of equipment. If this manual becomes damaged or unreadable, it should be replaced immediately. Contact your local Ventrac dealer for a replacement.

When using a Ventrac attachment, be sure to read and follow the safety and operating instructions of both the power unit and the attachment being used to ensure the safest operation possible.

The information in this manual provides the operator with the safest procedures to operate the machine while getting the maximum use out of the unit. Failure to follow the safety precautions listed in this manual may result in personal injury and/or damage to the equipment.

# INTRODUCTION

## Using Your Manual

This manual identifies potential hazards and safety concerns to help you, as well as others, avoid personal injury and/or damage to the equipment.

Safety should always be the first priority when working on or operating equipment. Accidents are more likely to occur when proper operating procedures are not followed or inexperienced operators are involved.

### **SYMBOL DEFINITIONS**



This symbol identifies potential health and safety hazards. It marks safety precautions. Your safety and the safety of others is involved.

There are three signal words that describe the level of safety concern: Danger, Warning, and Caution.

### **SIGNAL WORD DEFINITIONS**

#### **DANGER**

Indicates an imminently hazardous situation which, if not avoided, will result in death or serious injury. This signal word is limited to the most extreme cases.

#### **WARNING**

Indicates a potentially hazardous situation which, if not avoided, could result in death or serious injury.

#### **CAUTION**

Indicates a potentially hazardous situation which, if not avoided, may result in minor or moderate injury and/or property damage. It may also be used to alert against unsafe practices.

This manual also uses two words to highlight information. **ATTENTION** calls attention to special mechanical information to prevent equipment damage and/or best practices for equipment service and care.

**NOTE** emphasizes general information that is worthy of special attention.

NOTE: Right-Hand and Left-Hand orientations may be referred to at different places throughout this manual. Right-Hand and Left-Hand is determined as if facing forward from the operator station.

## Manual Glossary

- Power Unit** A Ventrac tractor or other Ventrac engine powered device that may be operated by itself or with an attachment or accessory.
- Attachment** A piece of Ventrac equipment that requires a Power Unit for operation.
- Accessory** A device that attaches to a Power Unit or Attachment to extend its capabilities.
- Machine** Describes any "Attachment" or "Accessory" that is used in conjunction with a power unit.

# SAFETY

---



## General Safety Procedures for Ventrac SSV Power Units, Attachments, & Accessories



### Training Required

- The owner of this machine is solely responsible for properly training the operators.
- The owner/operator is solely responsible for the operation of this machine and for the prevention of accidents or injuries occurring to him/herself, other people, or property.
- Do not allow operation or service by children or untrained personnel. Local regulations may restrict the age of the operator.
- Before operating this machine, read the operator's manual and understand its contents.
- If the operator of the machine cannot understand this manual, then it is the responsibility of this machine's owner to fully explain the material within this manual to the operator.
- Learn and understand the use of all the controls.
- Know how to stop the power unit and the attachments quickly in the event of an emergency.

### Requirements for Personal Protective Equipment (PPE)

- The owner is responsible for ensuring that all the operators use the proper PPE while operating the machine. Whenever you use the machine, use the following PPE:
- Certified eye protection and hearing protection.
- Closed toe, slip resistant footwear.
- Long pants or trousers.
- A dust mask for dusty conditions.
- Appropriate cold weather clothing.
- Additional PPE may be required. Refer to the product safety procedures for any additional requirements.

### Operation Safety

- Secure long hair and loose clothing. Do not wear jewelry.
- Inspect the machine before operation. Repair or replace any damaged, worn, or missing parts. Be sure the guards and shields are in proper working condition and are secured in place. Make any necessary adjustments before operating the machine.
- Some pictures in this manual may show shields or covers opened or removed in order to clearly illustrate the instructions. Under no circumstance should the machine be operated without these devices in place.
- Alterations or modifications to this machine can reduce safety and could cause damage to the machine. Do not alter the safety devices or operate with the shields or covers removed.
- Before each use, verify that all the controls function properly and inspect all the safety devices. Do not operate if the controls or safety devices are not in proper working condition.
- Check the parking brake function before operating. Repair or adjust the parking brake if necessary.
- Observe and follow all of the safety decals.
- All the controls are to be operated from the operator's station only.
- Ensure the attachment or accessory is locked or fastened securely to the power unit before operating.

# SAFETY

---



## General Safety Procedures for Ventrac SSV Power Units, Attachments, & Accessories



- Ensure that all bystanders are clear of the power unit and the attachment before operating. Stop the machine if someone enters your work area.
- Always be alert to what is happening around you, but do not lose focus on the task you are performing. Always look in the direction the machine is moving.
- Look behind and down before backing up to be sure of a clear path.
- If you hit an object, stop and inspect the machine. Make any necessary repairs before operating the machine again.
- Stop operation immediately at any sign of equipment failure. An unusual noise can be a warning of equipment failure or a sign that maintenance is required. Make any necessary repairs before operating the machine again.
- Do not leave the machine unattended while it is running.
- Always park the machine on level ground.
- Always shut off the engine when connecting the attachment drive belt to the power unit.
- Never leave the operator's station without lowering the attachment to the ground, engaging the parking brake, shutting off the engine, and removing the ignition key. Make sure all moving parts have come to a complete stop before dismounting.
- Never leave the machine unattended without lowering the attachment to the ground, engaging the parking brake, shutting off the engine, and removing the ignition key.
- Only operate in well-lit conditions.
- Do not operate when there is a risk of lightning.
- Never direct the discharge of any attachment in the direction of people, buildings, animals, vehicles, or other objects of value.
- Never discharge material against a wall or obstruction. The material may ricochet back toward the operator.
- Use extra caution when approaching blind corners, shrubs, trees, or other objects that may obscure your vision.
- Do not run the engine in a building without adequate ventilation.
- Do not touch the engine or the muffler while the engine is running or immediately after stopping the engine. These areas may be hot enough to cause a burn.
- Do not change the engine governor settings or over-speed the engine. Operating the engine at excessive speeds may increase the hazard of personal injury.
- To reduce the hazard of fire, keep the battery compartment, engine, and muffler areas free of grass, leaves, excessive grease, and other flammable materials.
- Clear the working area of objects that might be hit or thrown from the machine.
- Keep people and pets out of the working area.
- Know the work area well before operation. Do not operate where traction or stability is questionable.
- Reduce speed when you are operating over rough ground.
- Equipment can cause serious injury and/or death when improperly used. Before operating, know and understand the operation and safety of the power unit and the attachment being used.

# SAFETY

---



## General Safety Procedures for Ventrac SSV Power Units, Attachments, & Accessories



- Do not operate the machine if you are not in good physical and mental health, if you will be distracted by personal devices, or if you are under the influence of any substance which might impair your decisions, dexterity, or judgment.
- Children are attracted to machine activity. Be aware of children and do not allow them in the work area. Turn off the machine if a child enters the work area.
- Power units, attachments, and accessories are not designed or intended for travel on public roadways. Never operate or travel on public roads or highways.
- Operate with safety lights when operating near roadways.
- Slow down and be careful of traffic when operating near or crossing roadways. Stop before crossing roads or sidewalks. Use care when approaching areas or objects that may obscure vision.

### Keep Riders Off

- Only allow the operator on the power unit. Keep riders off.
- Never allow riders on any attachment or accessory.

### Operating On Slopes

- Slopes can cause loss-of-control and tip-over accidents, which can result in severe injury or death. Be familiar with the emergency parking brake, along with the power unit controls and their functions.
- Do not operate on slopes greater than 10 degrees.
- Do not stop or start suddenly when operating on slopes.
- Variables such as wet surfaces and loose ground will reduce the degree of safety. Do not drive where the machine could lose traction or tip over.
- Keep alert for hidden hazards in the terrain.
- Stay away from drop-offs, ditches, and embankments.
- Sharp turns should be avoided when operating on slopes.
- Transport the machine with the attachment lowered or close to the ground to improve stability.
- While operating on slopes, drive in an up and down direction whenever possible. If turning is necessary while driving across slopes, reduce your speed and turn slowly in the downhill direction.

### Truck Or Trailer Transport

- Use care when loading or unloading the machine into a truck or trailer.
- Use full width ramps for loading the machine into a truck or trailer.
- The parking brake is not sufficient to lock the machine during transport. Always secure the power unit and/or attachment to the transporting vehicle securely using straps, chains, cables, or ropes. Both the front and rear straps should be directed down and outward from the machine.
- Shut off the fuel supply to the power unit during transport on a truck or trailer.
- Turn the battery disconnect switch to the Off position to shut off electrical power.



# SAFETY

---



## General Safety Procedures for Ventrac SSV Power Units, Attachments, & Accessories



### Maintenance

- Keep the safety decals legible. Remove all grease, dirt, and debris from the safety decals and instructional labels.
- If any decals are faded, illegible, or missing, contact your dealer promptly for replacements.
- When new components are installed, be sure that the current safety decals are affixed to the replacement components.
- If any component requires replacement, use only original Ventrac replacement parts.
- Always turn the battery disconnect to the Off position or disconnect the battery before performing any repairs. Disconnect the negative terminal first and the positive terminal last. Reconnect the positive terminal first and the negative terminal last.
- Keep all bolts, nuts, screws, and other fasteners properly tightened.
- Always lower the attachment to the ground, engage the parking brake, shut off the engine, and remove the ignition key. Make sure all moving parts have come to a complete stop before cleaning, inspecting, adjusting, or repairing.
- If the power unit, attachment, or accessory requires repairs or adjustments not instructed in the operator's manual, the power unit, attachment, or accessory must be taken to an authorized Ventrac dealer for service.
- Never perform maintenance on the power unit and/or attachment if someone is in the operator's station.
- Always use protective glasses when handling the battery.
- Check the fuel lines for tightness and wear on a regular basis. Tighten or repair them as needed.
- To reduce the hazard of fire, keep the battery compartment, engine, and muffler areas free of grass, leaves, and excess grease.
- Do not touch the engine, the muffler, or other exhaust components while the engine is running or immediately after stopping the engine. These areas may be hot enough to cause a burn.
- Allow the engine to cool before storing and do not store near an open flame.
- Do not change the engine governor settings or over-speed the engine. Operating engine at excessive speeds may increase the hazard of personal injury.
- Springs may contain stored energy. Use caution when disengaging or removing springs and/or spring loaded components.
- An obstruction or blockage in a drive system or moving/rotating parts may cause a buildup of stored energy. When the obstruction or blockage is removed, the drive system or moving/rotating parts may move suddenly. Do not attempt to remove an obstruction or blockage with your hands. Keep your hands, feet, and clothing away from all power-driven parts.

### Fuel Safety

- To avoid personal injury or property damage, use extreme care in handling gasoline. Gasoline is extremely flammable and the vapors are explosive.
- Do not refuel the machine while smoking or at a location near flames or sparks.
- Always refuel the machine outdoors.
- Do not store the machine or fuel container indoors where the fumes or fuel can reach an open flame,

# SAFETY

---



## General Safety Procedures for Ventrac SSV Power Units, Attachments, & Accessories



spark, or pilot light.

- Only store fuel in an approved container. Keep out of the reach of children.
- Never fill containers inside a vehicle or on a truck or trailer bed with a plastic liner. Always place the containers on the ground away from your vehicle before filling.
- Remove the machine from the truck or trailer and refuel it on the ground. If this is not possible, refuel the machine using a portable container, rather than from a fuel dispenser nozzle.
- Never remove the fuel cap or add fuel with the engine running. Allow the engine to cool before refueling.
- Never remove the fuel cap while on a slope. Only remove the fuel cap when parked on a level surface.
- Replace the fuel tank cap and the container cap securely.
- Do not overfill the fuel tank. Only fill to the bottom of the fuel neck, do not fill the fuel neck full. Overfilling of the fuel tank could result in engine flooding, fuel leakage from the tank, and/or damage to the emissions control system.
- If fuel is spilled, do not attempt to start the engine. Move the power unit away from the fuel spill and avoid creating any source of ignition until the fuel vapors have dissipated.
- If the fuel tank must be drained, it should be drained outdoors into an approved container.
- Check the fuel lines for tightness and wear on a regular basis. Tighten or repair them as needed.
- The fuel system is equipped with a shut-off valve. Shut off the fuel when transporting the machine to and from the job, when parking the machine indoors, or when servicing the fuel system.

### Hydraulic Safety

- Make sure the hydraulic connections are tight and all hydraulic hoses and tubes are in good condition. Repair any leaks and replace any damaged or deteriorated hoses or tubes before starting the machine.
- Hydraulic leaks can occur under high pressure. Hydraulic leaks require special care and attention.
- Use a piece of cardboard and a magnifying glass to locate suspected hydraulic leaks.
- Keep your body and hands away from pinhole leaks or nozzles that eject high pressure hydraulic fluid. Hydraulic fluid escaping under high pressure can penetrate the skin causing serious injury, leading to severe complications and/or secondary infections if left untreated. If hydraulic fluid is injected into the skin, seek immediate medical attention no matter how minor the injury appears.
- The hydraulic system may contain stored energy. Before performing maintenance or repairs on the hydraulic system, remove any attachments, engage the parking brake, disengage the weight transfer system (if equipped), shut off the engine, and remove the ignition key. To relieve pressure on the auxiliary hydraulic system, shut off the power unit engine and move the hydraulic control lever left and right before disconnecting the auxiliary hydraulic quick couplers.

# SAFETY

---



## ND420 Safety Procedures



- The attachment hydraulic system may contain stored energy. Before performing maintenance or repairs on the hydraulic system, the attachment's auxiliary hydraulic hoses must be disconnected from the power unit. Lower the attachment to the ground, shut off power unit engine, move the hydraulic control lever left and right to relieve auxiliary hydraulic pressure, and disconnect the auxiliary hydraulic quick couplers.
- Always block up the snow plow securely when adjusting the skid shoes.
- Operators should be familiar with the area they are clearing and make preparations ahead of time. Place guide stakes appropriately and remove stones, markers, or other debris that may be hidden after a snow-fall. Curbs, offsets, steps, man hole covers, broken or raised pavement, etc. should be noted. Operators should map areas to be cleared before the winter season so they can review potential hazards prior to clearing snow in the area.
- If an area is to be cleared that is unfamiliar to the operator, travel slowly and use EXTREME CAUTION. Inquire of anyone who might know of potential hazards.
- Never travel at speeds that would cause injury to the operator or damage to the machine if the machine were to be stopped suddenly by an unseen, immovable object.
- Ensure there are no objects between the snow plow and the power unit. When the blade is angled, objects may be crushed between the blade and power unit.
- Do not operate in poor visibility conditions.

# SAFETY

## Safety Decals

The following safety decals must be maintained on your attachment.

Keep all safety decals legible. Remove all grease, dirt, and debris from safety decals and instructional labels. If any decals are faded, illegible, or missing, contact your dealer promptly for replacements.

When new components are installed, be sure that current safety decals are affixed to the replacement components.

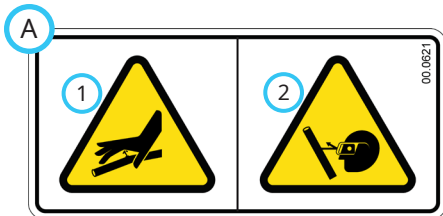
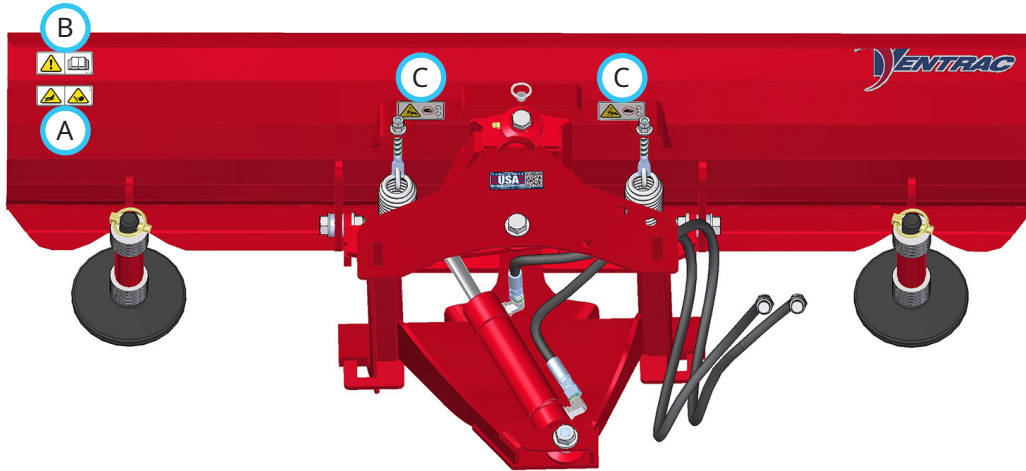

1. Keep your body and hands away from suspected hydraulic leaks.
2. Wear eye protection when inspecting the hydraulic system for leaks.

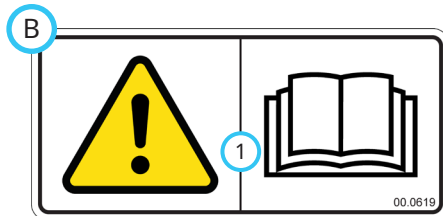

1. Read the operator's manual.



1. Caution - pinch point. Stay away from moving parts.

Decal	Description	Part Number	Quantity
A	High Pressure Fluid Hazard	00.0621	1
B	Read Operator's Manual	00.0619	1
C	Warning, Pinch Point	00.0364	2

# OPERATIONAL CONTROLS

---

## Plow Blade Angle

The hydraulic control lever\* on the power unit controls the angle of the plow blade. The plow blade can be angled up to 30 degrees to the right or left.

### **WARNING**

When the blade is being angled, pinch points are created at the trailing edge of the blade. Make sure there are no people or objects present between the blade and power unit.

\*Refer to power unit operator's manual for operation of power unit controls.

# GENERAL OPERATION

## Daily Inspection

### **⚠ WARNING**

Always engage the parking brake, shut off the power unit engine, remove the ignition key, and ensure that all moving parts have come to a complete stop before inspecting the components, or attempting any repair or adjustment.

1. Park the machine on a level surface, with the engine shut off and all fluids cold.
2. Perform a visual inspection of both the power unit and the attachment. Look for loose or missing hardware, damaged components, or signs of wear.
3. Inspect the hydraulic hoses and the hydraulic fittings to ensure tight, leak free connections.
4. Inspect the cutting edge and skid shoes for wear and service as required.

## Attaching

1. Align the power unit squarely with the snow plow. Lower the power unit hitch until the hitch tabs are below the top plate (A) on the snow plow hitch frame.
2. Drive forward slowly until the power unit hitch tabs are aligned with the hitch point slots (B) in the snow plow hitch frame. Raise the power unit hitch to engage the tabs in the hitch frame. Continue to raise the hitch until the snow plow is lifted off the ground.
3. Engage the parking brake\* and shut off the power unit engine.
4. Rotate the attachment latch handle\* forward to the latched position. Make sure the latch tabs are engaged in the lower latch plates, and the latch handle lock is engaged to prevent accidental disengagement of the latch handle.
5. Wipe the hose ends clean and connect to the power unit's hydraulic quick couplers. Connect the hoses and the quick couplers so the colored indicators are paired together (red to red, etc.).

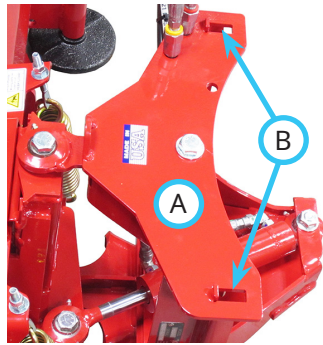

## Detaching

1. Park the power unit on a level surface and set the parking brake.\*
2. Lower the snow plow to the ground.
3. Shut off the power unit engine.
4. Move the hydraulic control lever left and right to release pressure from the auxiliary hydraulic circuit, disconnect the hydraulic quick couplers from the power unit, and store the hose ends in the top frame holes on the snow plow.
5. Disengage the latch handle lock\* and rotate the attachment latch handle\* back to unlatch from the attachment's lower latch plates.
6. Restart the power unit and lower the hitch until the tabs clear the top plate on the snow plow while slowly backing away from the snow plow.

## Operating Procedure

Before operation, perform daily inspection and verify skid shoes are set at the desired position.

Set the weight transfer (if equipped) to the Off position.

Move the power unit's hydraulic control lever to the left or right to set the desired angle and direction of the plow blade.

Move the machine into position and lower the snow plow to the ground. If skid shoes are used to determine the depth of the plow, place the power unit's hydraulic control lever in the float position by pushing it forward until the detent engages. The lever will stay in this position until intentionally removed.

When cleaning hard packed snow from hard surfaces, slight down pressure on the snow plow may be used. Push the hydraulic control lever forward until there is slight down pressure on the plow and then release.

Drive forward slowly while keeping a close watch for potential hazards.

### **⚠ WARNING**

Sudden deceleration caused by large amounts of material or hidden objects may cause injury to the operator and/or damage to the machine.

Do not push or ram materials at high speeds.

\*Refer to power unit operator's manual for operation of power unit controls.

# GENERAL OPERATION

## Transport of the Attachment

Transport the snow plow in the raised position to reduce wear of the machine and to prevent the snow plow blade from catching on curbs or other obstacles. Travel slowly over rough or slippery surfaces in order to maintain control of the power unit.

## Resetting the Blade Safety Trip

### **⚠ WARNING**

When the blade safety trip is activated, the plow blade may suddenly return to the operating position causing personal injury from pinching.

When the blade safety trip is activated, do not leave the operator platform or attempt to manually reset the plow blade.

If the blade safety trip is activated but the plow blade does not reset itself, do not attempt to raise the snow plow. Slowly back away from the obstacle. The plow blade will return to the operating position when it is moved away from the obstacle on which it is caught.

## Skid Shoe Adjustment

Skid shoes are provided to keep the cutting edge off the surface to be cleared, especially when clearing snow from gravel driveways or walkways.

The skid shoe height is determined by the placement of spacer washers between the skid shoe and the skid shoe mount. Extra washers are stored on top of the skid shoe mount.

1. Park the power unit and snow plow on a level surface and engage the parking brake.
2. Determine the number of spacer washers that need to be moved to reach the desired skid shoe height.

### **⚠ WARNING**

Hydraulic drift or accidental release of hydraulic pressure could allow the snow plow to lower and trap a person or appendage.

When making adjustments with the snow plow in the raised position, support the snow plow securely with blocks or jack stands under the cutting edge.

3. Raise the snow plow to the highest position and adjust the plow angle so the plow blade is perpendicular to the power unit. Support the plow blade securely with blocks or jack stands.

4. Remove the linch pin (A) and the spacer washers (B) from the top of the skid shoe mount.

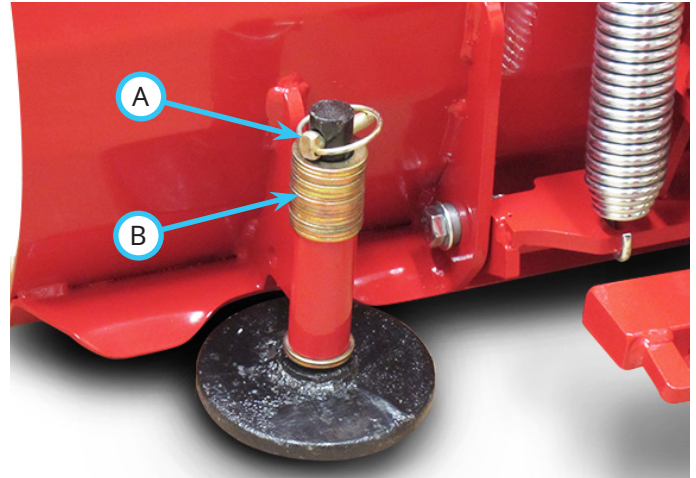

5. Remove the skid shoe from the bottom of the skid shoe mount. Add or remove spacer washers to reach the desired skid shoe height.
6. Insert the skid shoe back into the skid shoe mount, place any extra spacer washers on top of the skid shoe mount, and fasten the skid shoe in place with the linch pin. Both the left and right skid shoes should be set at the same height.
7. Remove the blocks or jack stands and lower the snow plow to the ground.

NOTE: skid shoes should be set low enough to support the back of the snow plow when it is detached from the power unit, so the plow frame is in position for easy reattachment.



# SERVICE

## **WARNING**

Always engage the parking brake, shut off the power unit engine, remove the ignition key, and ensure that all moving parts have come to a complete stop before inspecting the components, or attempting any repair or adjustment.

## **ATTENTION**

If any component requires replacement, use only original Ventrac replacement parts.

### **Cleaning and General Maintenance**

For best results, and to maintain the finish of the snow plow, clean or wash the snow plow to remove dirt, salt deposits, and snow or ice accumulations.

## **ATTENTION**

To maintain the finish of the power unit and attachment, thoroughly wash the equipment after each use to remove any corrosive agents (e.g., salt). Failure to clean the equipment may result in corrosion of (including but not limited to) steel, aluminum, and electrical components. Equipment that will experience repeated exposure to corrosive agents should be pretreated with a corrosion preventative.

### **Cutting Edge Reversal/Replacement**

If the cutting edge wears down near the blade frame structure, remove the cutting edge and flip it over so the unworn top edge is now on the bottom. Reinstall the cutting edge onto the plow blade. When both sides of the cutting edge have been worn down, the cutting edge will need to be replaced.

### **Skid Shoe Replacement**

The skid shoes should be replaced when the wear surface is less than 3 mm (1/8 inch) thick.

### **Optional Polyurethane Cutting Edge Adjustment/Reversal**

When the polyurethane cutting edge wears down near the blade frame, remove the poly edge from the blade frame, move down to align the upper set of mounting holes with the holes in the blade frame, and reinstall onto the blade frame. This provides an additional 28.5 mm (1-1/8 inch) of wear.

When the poly edge wears down near the blade frame again, remove the poly edge and flip it over so the unworn top edge is now on the bottom. Reinstall the poly edge onto the blade frame using the lower set of mounting holes. When the poly edge wears down, reposition to use the upper set of mounting holes to provide an additional 28.5 mm (1-1/8 inch) of wear.

After both sides of the polyurethane cutting edge have been worn down, the cutting edge will need to be replaced.



# SERVICE

## Lubrication Locations

Lubrication is required at the following locations using a lithium complex NLGI #2 grease.

Wipe the grease fittings clean before applying grease to the grease fittings.

Refer to the maintenance schedule for service intervals and the amount of grease.

Grease the cylinder ends. Rotate the cylinder body to raise the rear grease fitting above the edge of the frame.

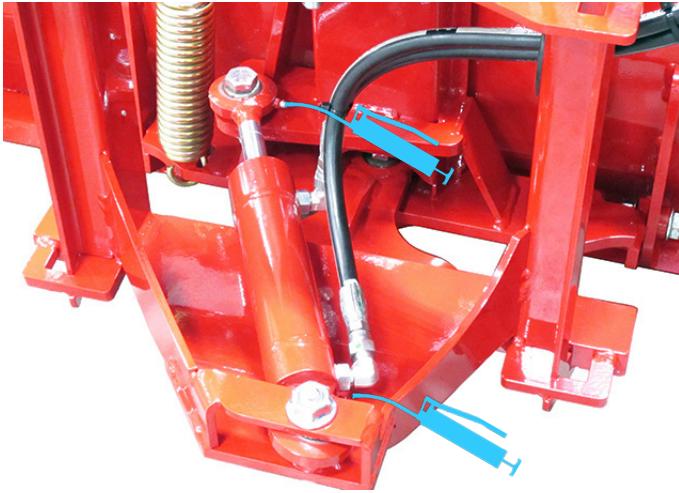

Grease the upper pivot link and the lower frame pivot. Angling the snow plow blade to the left increases access to the grease fitting in the lower frame pivot.

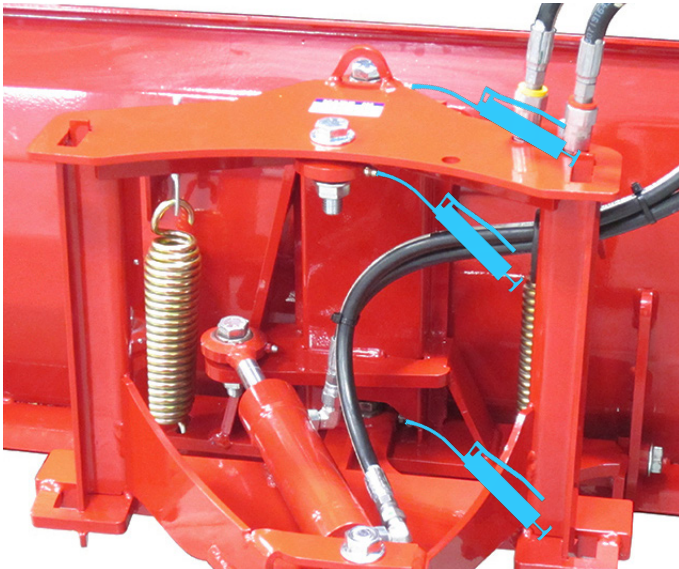

## Storage

### Preparing the Attachment for Storage

1. Clean the attachment to remove accumulated dirt, salt deposits, and snow or ice accumulations.
2. Inspect for loose or missing hardware, damaged components, or signs of wear. Repair or replace any damaged or worn components.
3. Inspect the cutting edge and skid shoes for wear and service as required.
4. Inspect the safety decals. Replace any decals that are faded, illegible, or missing.
5. Apply grease to all grease points and wipe off any excess grease.
6. Inspect the painted components for chips, scratches, or rust. Clean and touch up the surfaces as needed.

### Removing the Attachment from Storage

1. Clean the attachment to remove any accumulated dust or debris.
2. Inspect the attachment as instructed in the Daily Inspection section of this manual.
3. Test the attachment to ensure that all the components are working properly.

# SERVICE

## Maintenance Schedule

	# of locations	# of pumps	As Needed	Daily	At 50 hours	At 100 hours	At 150 hours	At 200 hours	At 250 hours	At 300 hours	At 350 hours	At 400 hours	At 450 hours	At 500 hours	At 550 hours	At 600 hours	At 650 hours	At 700 hours	At 750 hours	At 800 hours	At 850 hours	At 900 hours	At 950 hours	At 1,000 hours	Yearly
Grease and Lubrication: See Lubrication Section																									
Cylinder Ends	2	^	**		✓	✓	✓	✓	✓	✓	✓	✓	✓	✓	✓	✓	✓	✓	✓	✓	✓	✓	✓	✓	✓
Upper Pivot Link	2	^	**		✓	✓	✓	✓	✓	✓	✓	✓	✓	✓	✓	✓	✓	✓	✓	✓	✓	✓	✓	✓	✓
Lower Frame Pivot	1	^	**		✓	✓	✓	✓	✓	✓	✓	✓	✓	✓	✓	✓	✓	✓	✓	✓	✓	✓	✓	✓	✓
Inspection																									
Inspect for Loose, Missing, or Worn Components				✓																					
Inspect the Cutting Edge and skid Shoes				✓																					
Inspect the Hydraulic Hoses and Fittings				✓																					
Inspect the Safety Decals				✓																					
^Grease until fresh grease is visible.																									
**Operation in severe conditions may require more frequent service intervals.																									

## Maintenance Checklist

	# of locations	# of pumps	As Needed	Daily	At 50 hours	At 100 hours	At 150 hours	At 200 hours	At 250 hours	At 300 hours	At 350 hours	At 400 hours	At 450 hours	At 500 hours	At 550 hours	At 600 hours	At 650 hours	At 700 hours	At 750 hours	At 800 hours	At 850 hours	At 900 hours	At 950 hours	At 1,000 hours	Yearly
Grease and Lubrication: See Lubrication Section																									
Cylinder Ends	2	^	**																						
Upper Pivot Link	2	^	**																						
Lower Frame Pivot	1	^	**																						
Inspection																									
Inspect for Loose, Missing, or Worn Components																									
Inspect the Cutting Edge and skid Shoes																									
Inspect the Hydraulic Hoses and Fittings																									
Inspect the Safety Decals																									
^Grease until fresh grease is visible.																									
**Operation in severe conditions may require more frequent service intervals.																									

# SPECIFICATIONS

---

## Dimensions

Overall Height . . . . .	49.5 cm (19-1/2 inches)
Overall Length . . . . .	53.3 cm (21 inches)
Overall Width . . . . .	137.2 cm (54 inches)
Angled Width . . . . .	119.4 cm (47 inches)
Weight . . . . .	87.5 kg (193 pounds)
Angle . . . . .	30 degrees
Ground clearance in raised position (no angle) . . . . .	27.9 cm (11 inches)

## Features

- Reversible and replaceable cutting edge
- Adjustable skid shoes
- Spring controlled plow blade safety trip mechanism
- Self leveling blade

Visit [ventrac.com/manuals](http://ventrac.com/manuals)  
for the latest version of this operator's manual.  
A downloadable parts manual is also available.

