



Operator's Manual

MZ480

Brush Cutter





500 Venture Drive
Orrville, OH 44667
www.ventrac.com

To the Owner Contact Information and Product Identification

If you need to contact an authorized Ventrac dealer for information on servicing your product, always provide the product model and serial numbers.

Please fill in the following information for future reference. See the picture(s) below to find the location of the identification numbers. Record them in the spaces provided.

Dealer _____ Date of Purchase: _____

Dealer Address: _____

Dealer Phone Number: _____ Dealer Fax Number: _____

With your mobile device, you can scan the QR code on the serial number plate to access manuals, warranty, and other product information.



Model # _____

Serial # _____



Venture Products Inc. reserves the right to make changes in design or specifications without obligation to make like changes on previously manufactured products.

TABLE OF CONTENTS

INTRODUCTION	PAGE 4
Product Description	4
Why Do I Need an Operator’s Manual?	4
Using Your Manual	5
Manual Glossary	5
SAFETY	PAGE 6
General Safety Procedures	6
Training Required	6
Requirements for Personal Protective Equipment (PPE)	6
Operation Safety.	6
Keep Riders Off	8
Operating On Slopes	8
Truck Or Trailer Transport	8
Maintenance	9
Fuel Safety	10
Hydraulic Safety	10
Cutting Unit Safety	11
Safety Decals.	12
OPERATIONAL CONTROLS	PAGE 14
Cutting Height Positions	14
Attaching/Detaching Pin Position	14
Deck Belt Tension Handle.	14
GENERAL OPERATION	PAGE 15
Daily Inspection	15
Attaching	15
Detaching.	15
Operating Procedure	16
Transport of the Attachment.	16
SERVICE	PAGE 17
Cleaning and General Maintenance.	17
Deck Cover Removal and Installation	17
Deck Flip Up Procedure (Service Position)	17
Blade Inspection/Replacement	18
Blade Sharpening	18
Belt Inspection.	18
Attachment Drive Belt Replacement	19
Deck Belt Replacement	19
Deck Belt Tension Adjustment	20
Lubrication Locations	20
Storage	20
Maintenance Schedule	21
Maintenance Checklist	21
SPECIFICATIONS	PAGE 22
Dimensions.	22
Features.	22

INTRODUCTION



Venture Products Inc. is pleased to provide you with your new Ventrac MZ480 brush mower! We hope that Ventrac equipment will provide you with a ONE Tractor Solution.



Product Description

The MZ480 brush cutter is designed to level brush, tall weeds, heavy vegetation, saplings, and material up to 7.6 cm (3 inches) in diameter.

The MZ480 brush cutter is intended for use on 4500 and 4520 machines that are equipped with the weight transfer system.

Why Do I Need an Operator's Manual?

This manual has been created to help you gain the important knowledge of what is needed to safely operate and maintain your machine, and to avoid injury and product damage. It is divided into chapters for convenient reference of the appropriate information.

You must read and understand the operator's manual for each piece of Ventrac equipment you own. Reading the operator's manual will help you become familiar with each specific piece of equipment. If this manual becomes damaged or unreadable, it should be replaced immediately. Contact your local Ventrac dealer for a replacement.

When using a Ventrac attachment, be sure to read and follow the safety and operating instructions of both the machine and the attachment being used to ensure the safest operation possible.

The information in this manual provides the operator with the safest procedures to operate the machine while getting the maximum use out of the unit. Failure to follow the safety precautions listed in this manual may result in personal injury and/or damage to the equipment.

INTRODUCTION

Using Your Manual

This manual identifies potential hazards and safety concerns to help you, as well as others, avoid personal injury and/or damage to the equipment.

Safety should always be the first priority when working on or operating equipment. Accidents are more likely to occur when proper operating procedures are not followed or inexperienced operators are involved.

SYMBOL DEFINITIONS



This symbol identifies potential health and safety hazards. It marks safety precautions. Your safety and the safety of others is involved.

There are three signal words that describe the level of safety concern: Danger, Warning, and Caution.

SIGNAL WORD DEFINITIONS

⚠ DANGER

Indicates an imminently hazardous situation which, if not avoided, will result in death or serious injury. This signal word is limited to the most extreme cases.

⚠ WARNING

Indicates a potentially hazardous situation which, if not avoided, could result in death or serious injury.

⚠ CAUTION

Indicates a potentially hazardous situation which, if not avoided, may result in minor or moderate injury and/or property damage. It may also be used to alert against unsafe practices.

This manual also uses two words to highlight information. **ATTENTION** calls attention to special mechanical information to prevent equipment damage and/or best practices for equipment service and care.

NOTE emphasizes general information that is worthy of special attention.

NOTE: Right-Hand and Left-Hand orientations may be referred to at different places throughout this manual. Right-Hand and Left-Hand is determined as if facing forward from the operator station.

Manual Glossary

- Machine** A Ventrac tractor or other Ventrac engine powered device that may be operated by itself or with an attachment or accessory.
- Attachment** A piece of Ventrac equipment that requires a Machine for operation.
- Accessory** A device that attaches to a Machine or Attachment to extend its capabilities.

SAFETY



General Safety Procedures for Ventrac Power Units, Attachments, & Accessories



Training Required

- The owner of this machine is solely responsible for properly training the operators.
- The owner/operator is solely responsible for the operation of this machine and for the prevention of accidents or injuries occurring to him/herself, other people, or property.
- Do not allow operation or service by children or untrained personnel. Local regulations may restrict the age of the operator.
- Before operating this machine, read the operator's manual and understand its contents.
- If the operator of the machine cannot understand this manual, then it is the responsibility of this machine's owner to fully explain the material within this manual to the operator.
- Learn and understand the use of all the controls.
- Know how to stop the power unit and the attachments quickly in the event of an emergency.

Requirements for Personal Protective Equipment (PPE)

- The owner is responsible for ensuring that all the operators use the proper PPE while operating the machine. Whenever you use the machine, use the following PPE:
- Certified eye protection and hearing protection.
- Closed toe, slip resistant footwear.
- Long pants or trousers.
- A dust mask for dusty conditions.
- Additional PPE may be required. Refer to the product safety procedures for any additional requirements.

Operation Safety

- Secure long hair and loose clothing. Do not wear jewelry.
- Inspect the machine before operation. Repair or replace any damaged, worn, or missing parts. Be sure the guards and shields are in proper working condition and are secured in place. Make any necessary adjustments before operating the machine.
- Some pictures in this manual may show shields or covers opened or removed in order to clearly illustrate the instructions. Under no circumstance should the machine be operated without these devices in place.
- Alterations or modifications to this machine can reduce safety and could cause damage to the machine. Do not alter the safety devices or operate with the shields or covers removed.
- Before each use, verify that all the controls function properly and inspect all the safety devices. Do not operate if the controls or safety devices are not in proper working condition.
- Check the parking brake function before operating. Repair or adjust the parking brake if necessary.
- Observe and follow all of the safety decals.
- All the controls are to be operated from the operator's station only.
- Always wear a seat belt if the machine has a roll cage/bar installed and in the upright position.
- Ensure the attachment or accessory is locked or fastened securely to the power unit before operating.
- Ensure that all bystanders are clear of the power unit and the attachment before operating. Stop the machine if someone enters your work area.

SAFETY



General Safety Procedures for Ventrac Power Units, Attachments, & Accessories



- Always be alert to what is happening around you, but do not lose focus on the task you are performing. Always look in the direction the machine is moving.
- Look behind and down before backing up to be sure of a clear path.
- If you hit an object, stop and inspect the machine. Make any necessary repairs before operating the machine again.
- Stop operation immediately at any sign of equipment failure. An unusual noise can be a warning of equipment failure or a sign that maintenance is required. Make any necessary repairs before operating the machine again.
- If equipped with a high/low range feature, never shift between high and low range while on a slope. Always move the machine to level ground and engage the parking brake before shifting range.
- Do not leave the machine unattended while it is running.
- Always park the machine on level ground.
- Always shut off the engine when connecting the attachment drive belt to the power unit.
- Never leave the operator's station without lowering the attachment to the ground, engaging the parking brake, shutting off the engine, and removing the ignition key. Make sure all moving parts have come to a complete stop before dismounting.
- Never leave the machine unattended without lowering the attachment to the ground, engaging the parking brake, shutting off the engine, and removing the ignition key.
- Only operate in well-lit conditions.
- Do not operate when there is a risk of lightning.
- Never direct the discharge of any attachment in the direction of people, buildings, animals, vehicles, or other objects of value.
- Never discharge material against a wall or obstruction. The material may ricochet back toward the operator.
- Use extra caution when approaching blind corners, shrubs, trees, or other objects that may obscure your vision.
- Do not run the engine in a building without adequate ventilation.
- Do not touch the engine or the muffler while the engine is running or immediately after stopping the engine. These areas may be hot enough to cause a burn.
- Do not change the engine governor settings or over-speed the engine. Operating the engine at excessive speeds may increase the hazard of personal injury.
- To reduce the hazard of fire, keep the battery compartment, engine, and muffler areas free of grass, leaves, excessive grease, and other flammable materials.
- Clear the working area of objects that might be hit or thrown from the machine.
- Keep people and pets out of the working area.
- Know the work area well before operation. Do not operate where traction or stability is questionable.
- Reduce speed when you are operating over rough ground.
- Equipment can cause serious injury and/or death when improperly used. Before operating, know and understand the operation and safety of the power unit and the attachment being used.
- Do not operate the machine if you are not in good physical and mental health, if you will be distracted by personal devices, or if you are under the influence of any substance which might impair your decisions, dexterity, or judgment.

SAFETY



General Safety Procedures for Ventrac Power Units, Attachments, & Accessories



- Children are attracted to machine activity. Be aware of children and do not allow them in the work area. Turn off the machine if a child enters the work area.
- Power units, attachments, and accessories are not designed or intended for travel on public roadways. Never operate or travel on public roads or highways.
- Operate with safety lights when operating near roadways.
- Slow down and be careful of traffic when operating near or crossing roadways. Stop before crossing roads or sidewalks. Use care when approaching areas or objects that may obscure vision.

Keep Riders Off

- Only allow the operator on the power unit. Keep riders off.
- Never allow riders on any attachment or accessory.

Operating On Slopes

- Slopes can cause loss-of-control and tip-over accidents, which can result in severe injury or death. Be familiar with the emergency parking brake, along with the power unit controls and their functions.
- If the power unit is equipped with a fold down roll bar, it must be locked in the upright position when operating on any slope.
- Use low range (if equipped) when operating on slopes greater than 15 degrees.
- Do not stop or start suddenly when operating on slopes.
- Never shift between high and low range while on a slope. Always move the power unit to level ground and engage the parking brake before shifting range or placing the power unit in neutral.
- Variables such as wet surfaces and loose ground will reduce the degree of safety. Do not drive where the machine could lose traction or tip over.
- Keep alert for hidden hazards in the terrain.
- Stay away from drop-offs, ditches, and embankments.
- Sharp turns should be avoided when operating on slopes.
- Pulling loads on hills decreases safety. It is the responsibility of the owner/operator to determine loads that can safely be controlled on slopes.
- Transport the machine with the attachment lowered or close to the ground to improve stability.
- While operating on slopes, drive in an up and down direction whenever possible. If turning is necessary while driving across slopes, reduce your speed and turn slowly in the downhill direction.
- Ensure a sufficient supply of fuel for continuous operation. A minimum of one-half tank of fuel is recommended.

Truck Or Trailer Transport

- Use care when loading or unloading the machine into a truck or trailer.
- Use full width ramps for loading the machine into a truck or trailer.

SAFETY



General Safety Procedures for Ventrac Power Units, Attachments, & Accessories



- The parking brake is not sufficient to lock the machine during transport. Always secure the power unit and/or attachment to the transporting vehicle securely using straps, chains, cables, or ropes. Both the front and rear straps should be directed down and outward from the machine.
- Shut off the fuel supply to the power unit during transport on a truck or trailer.
- If equipped, turn the battery disconnect switch to the Off position to shut off electrical power.

Maintenance

- Keep the safety decals legible. Remove all grease, dirt, and debris from the safety decals and instructional labels.
- If any decals are faded, illegible, or missing, contact your dealer promptly for replacements.
- When new components are installed, be sure that the current safety decals are affixed to the replacement components.
- If any component requires replacement, use only original Ventrac replacement parts.
- Always turn the battery disconnect to the Off position or disconnect the battery before performing any repairs. Disconnect the negative terminal first and the positive terminal last. Reconnect the positive terminal first and the negative terminal last.
- Keep all bolts, nuts, screws, and other fasteners properly tightened.
- Always lower the attachment to the ground, engage the parking brake, shut off the engine, and remove the ignition key. Make sure all moving parts have come to a complete stop before cleaning, inspecting, adjusting, or repairing.
- If the power unit, attachment, or accessory requires repairs or adjustments not instructed in the operator's manual, the power unit, attachment, or accessory must be taken to an authorized Ventrac dealer for service.
- Never perform maintenance on the power unit and/or attachment if someone is in the operator's station.
- Always use protective glasses when handling the battery.
- Check the fuel lines for tightness and wear on a regular basis. Tighten or repair them as needed.
- To reduce the hazard of fire, keep the battery compartment, engine, and muffler areas free of grass, leaves, and excess grease.
- Do not touch the engine, the muffler, or other exhaust components while the engine is running or immediately after stopping the engine. These areas may be hot enough to cause a burn.
- Allow the engine to cool before storing and do not store near an open flame.
- Do not change the engine governor settings or over-speed the engine. Operating engine at excessive speeds may increase the hazard of personal injury.
- Springs may contain stored energy. Use caution when disengaging or removing springs and/or spring loaded components.
- An obstruction or blockage in a drive system or moving/rotating parts may cause a buildup of stored energy. When the obstruction or blockage is removed, the drive system or moving/rotating parts may move suddenly. Do not attempt to remove an obstruction or blockage with your hands. Keep your hands, feet, and clothing away from all power-driven parts.

SAFETY



General Safety Procedures for Ventrac Power Units, Attachments, & Accessories



Fuel Safety

- To avoid personal injury or property damage, use extreme care in handling gasoline. Gasoline is extremely flammable and the vapors are explosive.
- Do not refuel the machine while smoking or at a location near flames or sparks.
- Always refuel the machine outdoors.
- Do not store the machine or fuel container indoors where the fumes or fuel can reach an open flame, spark, or pilot light.
- Only store fuel in an approved container. Keep out of the reach of children.
- Never fill containers inside a vehicle or on a truck or trailer bed with a plastic liner. Always place the containers on the ground away from your vehicle before filling.
- Remove the machine from the truck or trailer and refuel it on the ground. If this is not possible, refuel the machine using a portable container, rather than from a fuel dispenser nozzle.
- Never remove the fuel cap or add fuel with the engine running. Allow the engine to cool before refueling.
- Never remove the fuel cap while on a slope. Only remove the fuel cap when parked on a level surface.
- Replace the fuel tank cap and the container cap securely.
- Do not overfill the fuel tank. Only fill to the bottom of the fuel neck, do not fill the fuel neck full. Overfilling of the fuel tank could result in engine flooding, fuel leakage from the tank, and/or damage to the emissions control system.
- If fuel is spilled, do not attempt to start the engine. Move the power unit away from the fuel spill and avoid creating any source of ignition until the fuel vapors have dissipated.
- If the fuel tank must be drained, it should be drained outdoors into an approved container.
- Check the fuel lines for tightness and wear on a regular basis. Tighten or repair them as needed.
- The fuel system is equipped with a shut-off valve. Shut off the fuel when transporting the machine to and from the job, when parking the machine indoors, or when servicing the fuel system.

Hydraulic Safety

- Make sure the hydraulic connections are tight and all hydraulic hoses and tubes are in good condition. Repair any leaks and replace any damaged or deteriorated hoses or tubes before starting the machine.
- Hydraulic leaks can occur under high pressure. Hydraulic leaks require special care and attention.
- Use a piece of cardboard and a magnifying glass to locate suspected hydraulic leaks.
- Keep your body and hands away from pinhole leaks or nozzles that eject high pressure hydraulic fluid. Hydraulic fluid escaping under high pressure can penetrate the skin causing serious injury, leading to severe complications and/or secondary infections if left untreated. If hydraulic fluid is injected into the skin, seek immediate medical attention no matter how minor the injury appears.
- The hydraulic system may contain stored energy. Before performing maintenance or repairs on the hydraulic system, remove any attachments, engage the parking brake, disengage the weight transfer system (if equipped), shut off the engine, and remove the ignition key. To relieve pressure on the auxiliary hydraulic system, shut off the power unit engine and move the hydraulic control lever left and right before disconnecting the auxiliary hydraulic quick couplers.

SAFETY



MZ480 Safety Procedures



- The machine's weight transfer system must be set to a minimum of 2 on the weight transfer select lever.

Cutting Unit Safety

- Always inspect the machine to ensure the blades, blade bolts, and cutting assembly are not worn or damaged.
- Rotating Blade Hazard: Contact with the rotating mower blades or other moving parts may cause personal injury. Keep your hands and feet away.
- Thrown Object Hazard: Do not direct the mower discharge toward people, animals, or buildings. Never operate with the deflector(s) removed.
- Always shut off the PTO to stop the mower blades whenever you are not mowing, especially when crossing loose terrain such as gravel.
- Never raise the mower deck with the blades running.

SAFETY

Safety Decals

The following safety decals must be maintained on your attachment.

Keep all safety decals legible. Remove all grease, dirt, and debris from safety decals and instructional labels. If any decals are faded, illegible, or missing, contact your dealer promptly for replacements.

When new components are installed, be sure that current safety decals are affixed to the replacement components.

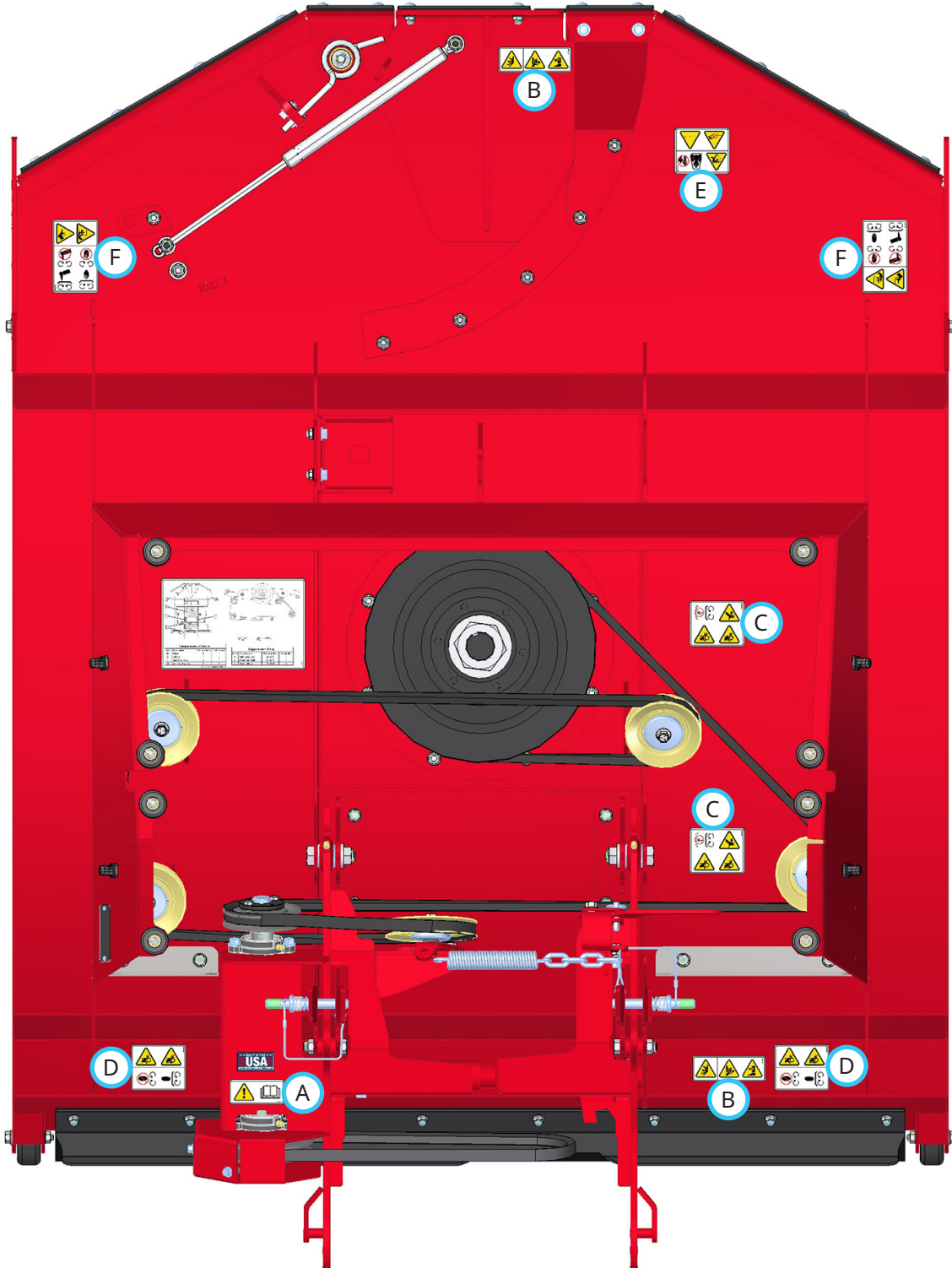

SAFETY

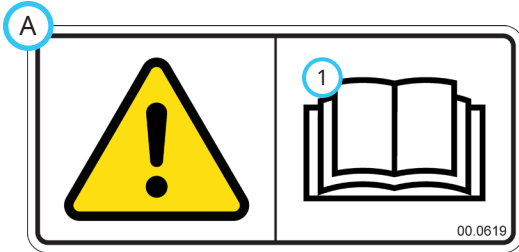

1. Read the operator's manual.

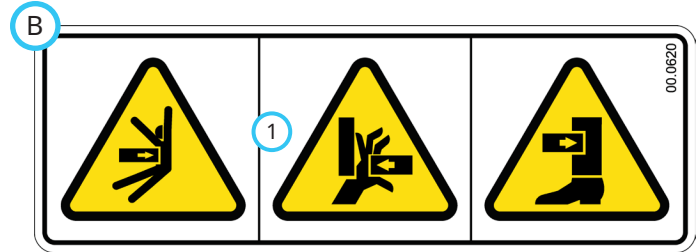

1. Pinching or crushing hazard.

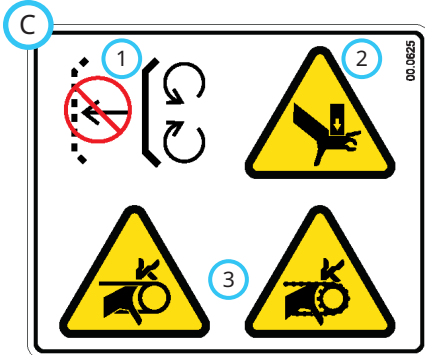

1. Shield missing - do not operate.
2. Pinching/crushing hazard.
3. Fingers or hand entanglement hazard.

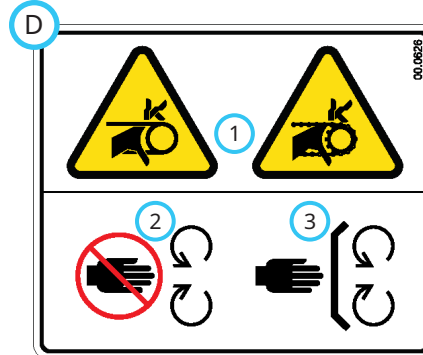

1. Fingers or hand entanglement hazard.
2. Stay away from moving parts.
3. Keep all guards and shields in place.

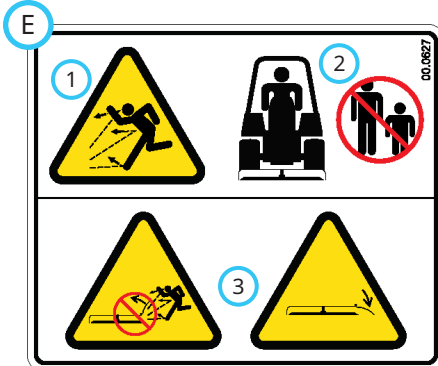

1. Thrown object hazard.
2. Keep bystanders away from the machine.
3. Do not operate with the deflector belt removed.

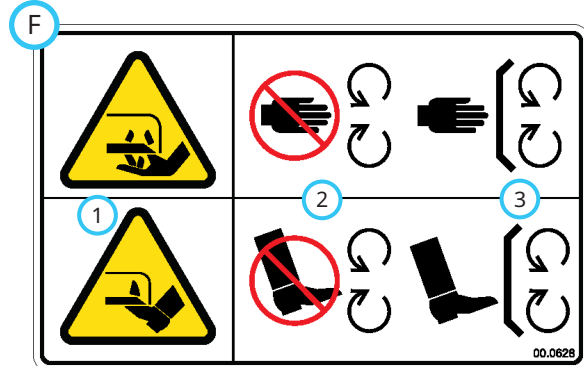

1. Cutting or dismemberment hazard of hand or foot - mower blade.
2. Stay away from moving parts.
3. Keep all guards and shields in place.

Decal	Description	Part Number	Quantity
A	Read Operator's Manual	00.0619	1
B	Pinching or Crushing Hazard	00.0620	2
C	Shield Missing	00.0625	2
D	Entanglement Hazard	00.0626	2
E	Thrown Object Hazard	00.0627	1
F	Cutting Hazard - Mower Blade	00.0628	2

OPERATIONAL CONTROLS

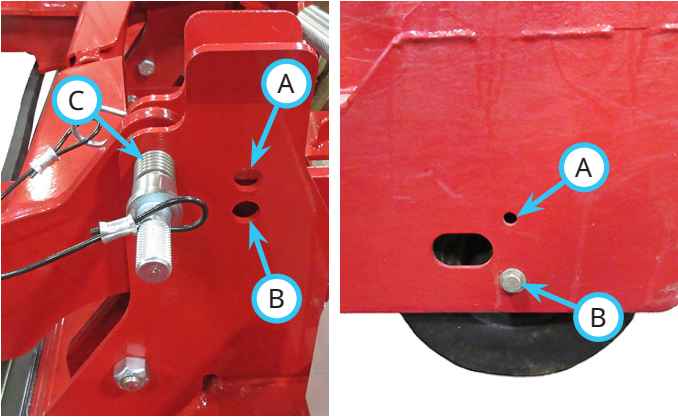

Cutting Height Positions

The MZ480 brush cutter has two cutting height positions of 7.6 cm (3 inches) or 12.7 cm (5 inches).

To set the cutting height at 7.6 cm (3 inches), The front wheels and the hitch arm pins are installed in the upper set of holes (A).

To set the cutting height at 12.7 cm (5 inches), The front wheels and the hitch arm pins are installed in the lower set of holes (B).

Attaching/Detaching Pin Position

Move the hitch arm pins to the attaching/detaching pin position (C) when detaching the brush mower from the machine. The pins should remain in this position until the brush mower is reattached to the machine.

Deck Belt Tension Handle

The deck belt tension handle (D) is used to release or apply tension to the deck belt. The belt tension handle must be released in order to flip the deck up to the service position.

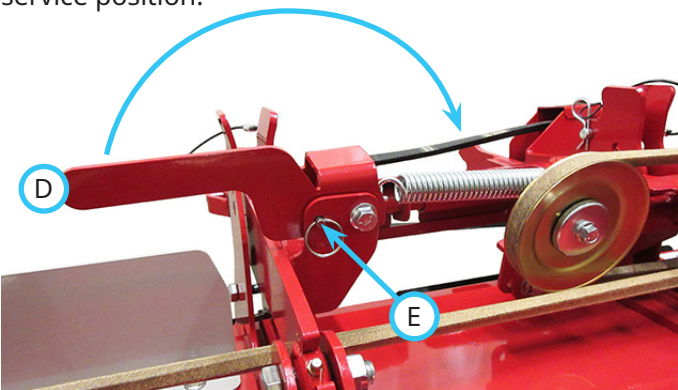

Remove the ball pin (E) from the deck belt tension handle and rotate 180 degrees to release the belt tension. To apply belt tension, rotate the belt tension handle to tension the spring and install the ball pin to lock in place.

GENERAL OPERATION

Daily Inspection

⚠ WARNING

Always engage the parking brake, shut off the machine's engine, remove the ignition key, and ensure that all moving parts have come to a complete stop before inspecting the components, or attempting any repair or adjustment.

1. Park the machine on a level surface, with the engine shut off and all fluids cold.
2. Perform a visual inspection of both the machine and the attachment. Look for loose or missing hardware, damaged components, or signs of wear.
3. Inspect the belts for damage or excessive wear. Refer to the Belt Inspection section of this manual.
4. Inspect the blades, the blade mounting bolts, and the cutting assembly for wear or damage.
5. Ensure that the blades swing freely and that there is nothing wrapped around the blade carrier frame.
6. Inspect the front and rear belting for wear or deterioration and replace as needed.

Attaching

1. Ensure the hitch arm pins are installed in the attaching/detaching position.
2. Drive the machine slowly forward into the hitch arms of the attachment. Align the lift arms of the machine with the attachment hitch arms by raising or lowering the front hitch and complete the engagement.

3. Once completely engaged, move the front hitch latch lever* to the locked position. The latch (A) must lock over the attachment's hitch arm pin (B).

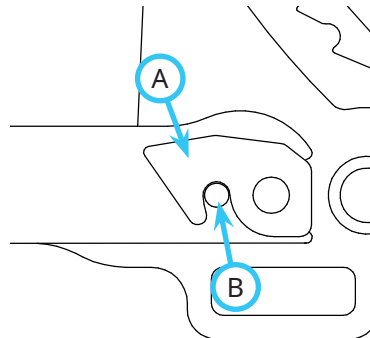

4. Engage the parking brake* and shut off the engine.
5. Place the attachment belt onto the PTO drive pulley on the machine. Ensure the belt is properly seated in each pulley.
6. Engage the PTO belt tensioner rod.
7. Move the hitch arm pins to the desired cutting height position. The hitch arm pin position must match the cutting height position of the front wheels.

Detaching

1. Park the machine on a level surface and engage the parking brake.*
2. Move the hitch arm pins to the attaching/detaching position.
3. Lower the attachment to the ground.
4. Shut off the machine's engine.
5. Disengage the PTO belt tensioner rod.
6. Remove the attachment belt from the PTO drive pulley of the machine.
7. Disengage the front hitch locking lever.*
8. Restart the machine and slowly back away from the attachment. A side to side movement of the steering wheel may aid in disengagement.

*Refer to machine operator's manual for operation of machine controls.

GENERAL OPERATION

Operating Procedure

⚠ WARNING

The machine's weight transfer system must be set to a minimum of 2 on the weight transfer select lever.

Before operation, perform the daily inspection, and confirm the mower is set at the desired cutting height.

Inspect the mowing area and remove rocks, sticks, and any other objects that could be thrown by the machine or could damage the blades and cutting assembly.

Lower the brush mower to the ground and place the machine's primary SDLA lever in the float position.

With the engine running between 2,000 and 3,000 RPM, engage the PTO switch, then adjust the throttle to the desired engine RPM.

When mowing, avoid obstacles and remove debris as necessary. The brush mower is equipped with a spring loaded gate (A) to allow cutting of materials that are too strong to push over. Align the material with the gate and drive forward slowly. After the material is cut, the gate will return to its normal position.

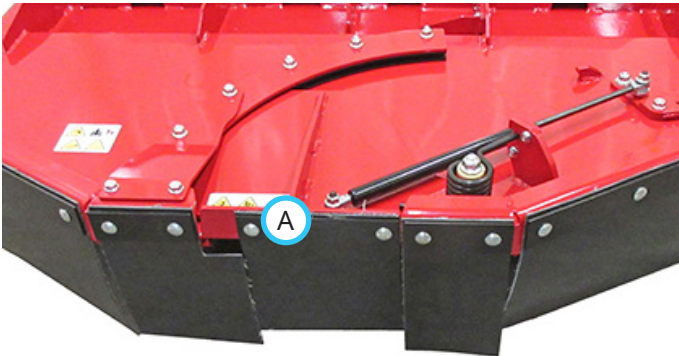

When mowing is complete or whenever the brush mower must be lifted off the ground, reduce the engine speed and shut off the PTO.

ATTENTION

Reduce the engine speed to low idle before shutting off the PTO.

Transport of the Attachment

Transport the attachment with the machine front hitch and attachment fully raised to reduce wear of the equipment. Travel slowly when transporting over undulating and rough surfaces to maintain control of the machine and to reduce the shock to the machine and the attachment. Always disengage the PTO before transporting the attachment.

SERVICE

⚠ WARNING

Always engage the parking brake, shut off the power unit engine, remove the ignition key, and ensure that all moving parts have come to a complete stop before inspecting the components, or attempting any repair or adjustment.

ATTENTION

If any component requires replacement, use only original Ventrac replacement parts.

Cleaning and General Maintenance

For best results, and to maintain the finish of the brush cutter, clean or wash the brush cutter to remove accumulated clippings, leaves, dirt, and debris when the job is finished. Refer to the Deck Flip Up Procedure to access the underside of the deck.

If washing the brush cutter, do not spray directly into bearings or seals. After washing, it is important to run the brush cutter so water does not reside on the seals or bearings for the drive system. When washing is complete, return the deck to the operating position. Move the machine to a clean, debris-free location and activate the PTO for 30 seconds to remove any standing water.

Deck Cover Removal and Installation

1. Unfasten the rubber latches for either the front, rear, or both top deck covers.
2. Lift the cover(s) off the deck.
3. To reinstall, align the holes in the deck cover(s) with the locating pins and lower onto the rubber pads.
4. Fasten the rubber latches to secure onto the deck.

Deck Flip Up Procedure (Service Position)

1. Park the machine and brush cutter on a smooth, level surface within reach of a hoist.
2. Engage the parking brake, shut off the engine, and remove the ignition key.
3. Remove the rear deck cover.
4. Remove the ball pin from the belt tension handle and rotate the handle 180 degrees to release the belt tension.
5. Remove the hitch arm pins from the hitch arm mounting brackets.
6. Remove the ball pins (A) from the front of the hitch arm mounting brackets.

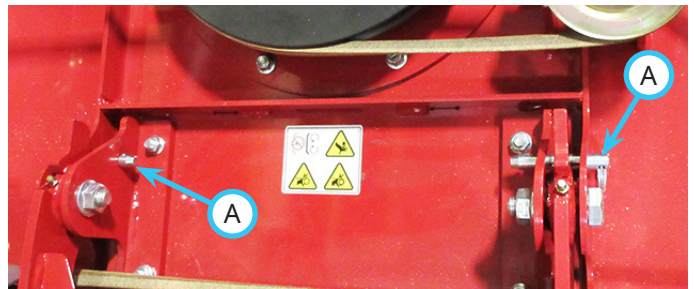

7. Restart the engine and raise the front hitch to its highest position.
8. Shut off the engine and remove the ignition key.
9. Attach a hoist to lift point (B) on the deck and lift the front of the deck up to a near vertical position.

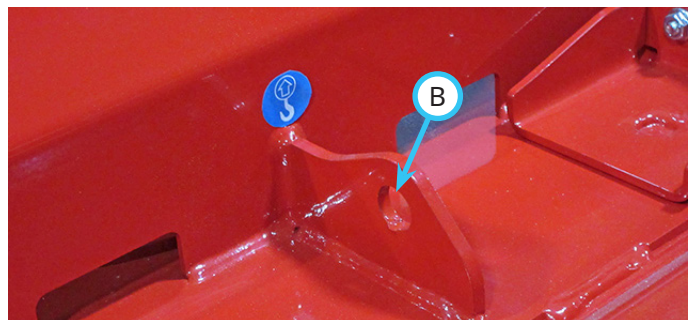

10. Insert the ball pins (A) in the front mounting holes to lock the deck in the upright position.

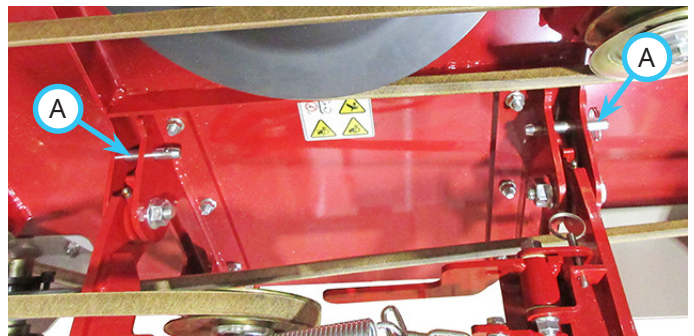

SERVICE

11. To return the deck to the operating position, use a hoist to support the deck while removing the hitch arm pins, then use the hoist to lower the deck to the operating position.
 12. Lower the brush cutter to the ground.
 13. Install the hitch arm pins into the hitch arm mounting brackets. Ensure the pin position matches the front wheel mount position. Refer to the cutting height decal in necessary.
 14. Install the ball pins into the front holes in the hitch arm mounting brackets.
 15. Ensure the belt is properly seated in the pulley grooves, then rotate the belt tension handle 180 degrees to engage belt tension and secure with the ball pin.
 16. Install the rear deck cover and secure with the rubber handles.
6. Rotate the blade carrier frame to position the other blade nut under the access hole and remove the nut and spacer from the blade bolt.
 7. Inspect the blades and the blade mounting hardware for cracking, bending, or other damage and replace as needed.

ATTENTION

To maintain balance of the cutting means, the blades must be replaced in sets.

8. Remove any string, wire, or other debris from the blade carrier frame.
9. When installing the blades, insert the bolt up through the blade and the blade carrier frame. Place the spacer onto the bolt and secure with the locking flange nut. Torque both blade nuts to 540 N·m (400 ft-lb).
10. After tightening the blade hardware, check to ensure the blades swing freely.

Blade Inspection/Replacement

WARNING

The blades are sharp; contacting the blades can result in serious personal injury.

Wrap the blade or wear protective gloves when servicing or replacing the blades.

1. Flip the deck up to the service position.
2. Inspect the blades to ensure they are sharp and in good condition. If the blades are dull or damaged, they must be removed and sharpened or replaced.
3. Remove the blade bolt access cover (A) from the top of the deck.



4. Rotate the blade carrier frame to position the blade nut under the access hole.
5. Use a socket and extension to remove the nut and spacer from the blade bolt.

Blade Sharpening

The cutter blades should be sharpened by a professional. Sharpen both of the blades at the same time. Sharpen both of the blades the same amount to maintain similar mass of the blades and balance of the cutter. Maintain the same bevel and the length of the sharpened surface.

Belt Inspection

Inspecting the drive belts of the attachment can prevent sudden belt failure by finding problems before they cause a belt to break.

Typical wear on a drive belt may result in the conditions shown in the diagram. If any of these conditions occur, the drive belt will require replacement.

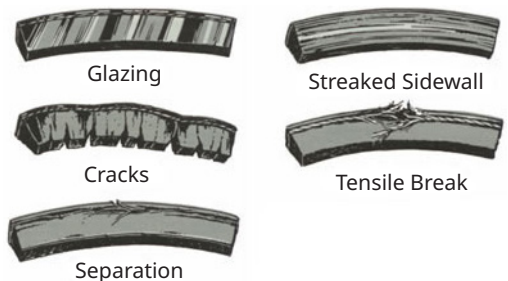

SERVICE

Attachment Drive Belt Replacement

1. Detach the brush cutter from the machine.
2. Remove the drive pulley shield (A).

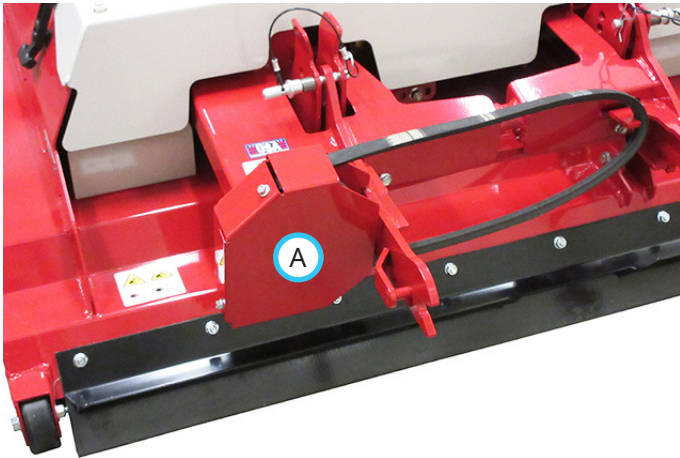

3. Remove the old attachment belt and install the new belt onto the pulley.
4. Install the drive pulley shield and torque the bolt to 11 N·m (100 in-lb).

Deck Belt Replacement

1. Detach the brush cutter from the machine.
2. Remove both top deck covers.
3. Remove the ball pin from the belt tension handle and rotate the handle 180 degrees to release the belt tension.
4. Remove the hitch arm pins from the hitch arm mounting brackets.
5. Remove the deck belt from the belt tensioner pulley and slide the loop of the belt over the end of the left hitch arm so that the belt is looped around the left hitch arm mounting brackets.

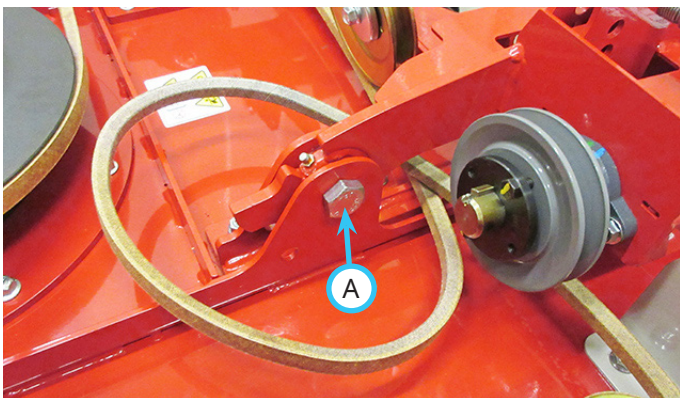

6. Remove the mounting bolts (A) from both the left and right hitch arms and lift the hitch arm assembly out of the mounting brackets.

7. Remove the old belt from the pulleys.
8. Install the new belt onto the pulleys as shown in the belt diagram.

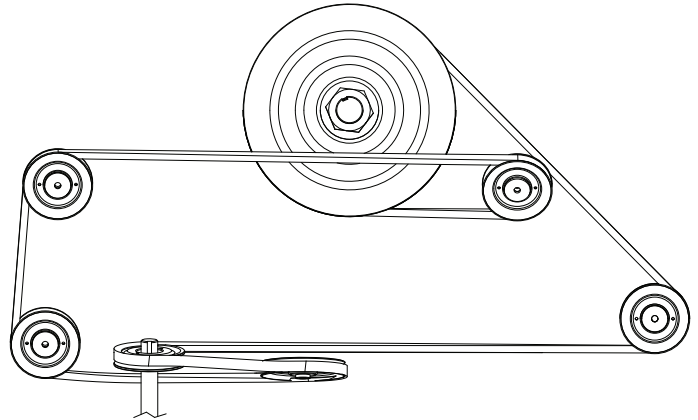

9. Loop the belt around the left hitch arm mounting bracket as shown in the hitch arm removal picture.
10. Install the left and right hitch arms into the hitch arm mounting brackets and torque the bolts to 205 N·m (151 ft-lb).
11. Place the belt loop onto the drive shaft pulley and the belt tensioner pulley.
12. Check to ensure the belt is routed properly and seated in the groove of each pulley.
13. Rotate the belt tension handle 180 degrees to engage belt tension, and secure with the ball pin.
14. Install the deck covers and secure with the rubber handles.

SERVICE

Deck Belt Tension Adjustment

If the deck belt slips during normal operation, the belt tension needs to be adjusted.

1. Remove the rear deck cover.
2. Remove the ball pin from the belt tension handle and rotate the handle 180 degrees to release the belt tension.
3. Move the extension spring hook (A) into the next chain link (B) closer to the belt tension handle.

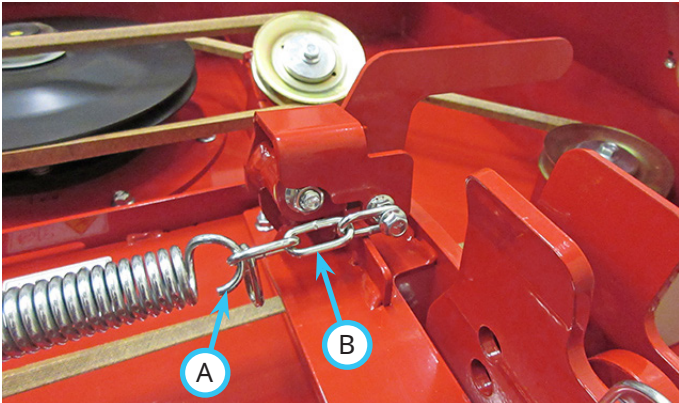

4. Rotate the belt tension handle 180 degrees to engage belt tension, and secure with the ball pin.
5. Install the rear deck cover and secure with the rubber handles.

Lubrication Locations

Lubrication is required at the following locations using a lithium complex NLGI #2 grease.

Wipe the grease fittings clean before applying grease to the grease fittings.

Refer to the maintenance schedule for service intervals and the amount of grease.

1. Apply grease to the front wheel axles.

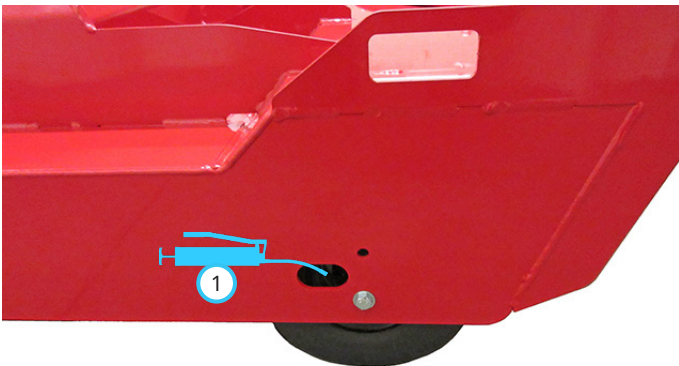

2. Apply grease to the spindle.

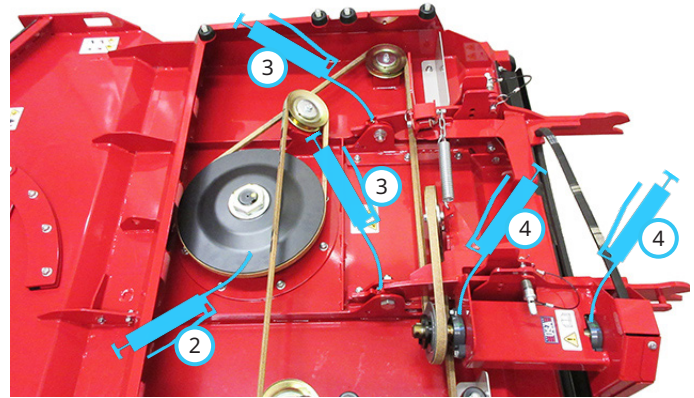

3. Apply grease to the hitch arm pivots.
4. Apply grease to the drive shaft bearings.

Storage

Preparing the Attachment for Storage

1. Clean the attachment to remove accumulated clippings, leaves, dirt, and debris.
2. Inspect for loose or missing hardware, damaged components, or signs of wear. Repair or replace any damaged or worn components.
3. Inspect the belts, the spindle, the blade carrier frame, and the blades. Repair or replace any damaged or worn components.
4. Inspect the safety decals. Replace any decals that are faded, illegible, or missing.
5. Apply grease to all grease points and wipe off any excess grease.
6. Inspect the painted components for chips, scratches, or rust. Clean and touch up the surfaces as needed.

Removing the Attachment from Storage

1. Clean the attachment to remove any accumulated dust or debris.
2. Inspect the attachment as instructed in the Daily Inspection section of this manual.
3. Test the attachment to ensure that all the components are working properly.

SERVICE

Maintenance Schedule

	# of locations	# of pumps	As Needed	Daily	At 50 hours	At 100 hours	At 150 hours	At 200 hours	At 250 hours	At 300 hours	At 350 hours	At 400 hours	At 450 hours	At 500 hours	At 550 hours	At 600 hours	At 650 hours	At 700 hours	At 750 hours	At 800 hours	At 850 hours	At 900 hours	At 950 hours	At 1,000 hours	Yearly
Grease and Lubrication: See Lubrication Section																									
Wheel	2	1			✓	✓	✓	✓	✓	✓	✓	✓	✓	✓	✓	✓	✓	✓	✓	✓	✓	✓	✓	✓	✓
Spindle	1	3			✓	✓	✓	✓	✓	✓	✓	✓	✓	✓	✓	✓	✓	✓	✓	✓	✓	✓	✓	✓	✓
Hitch Arm Pivot	2	^			✓	✓	✓	✓	✓	✓	✓	✓	✓	✓	✓	✓	✓	✓	✓	✓	✓	✓	✓	✓	✓
Drive Shaft Bearing	2	1			✓	✓	✓	✓	✓	✓	✓	✓	✓	✓	✓	✓	✓	✓	✓	✓	✓	✓	✓	✓	✓
Inspection																									
Inspect for Loose, Missing, or Worn Components				✓																					
Inspect the Belts and Pulleys				✓																					
Inspect the Blades and Blade Mounting Bolts (Torque to 540 N•m (400 ft-lb))				✓																					
Inspect the Blade Carrier Frame Bolts (Torque to 138 N•m (102 ft-lb))				✓																					
Inspect the Hitch Pivot Bolts (Torque to 205 N•m (151 ft-lb))					✓		✓			✓			✓			✓			✓			✓			✓
Inspect the Safety Decals				✓																					

^Grease until fresh grease is visible.

Maintenance Checklist

	# of locations	# of pumps	As Needed	Daily	At 50 hours	At 100 hours	At 150 hours	At 200 hours	At 250 hours	At 300 hours	At 350 hours	At 400 hours	At 450 hours	At 500 hours	At 550 hours	At 600 hours	At 650 hours	At 700 hours	At 750 hours	At 800 hours	At 850 hours	At 900 hours	At 950 hours	At 1,000 hours	Yearly
Grease and Lubrication: See Lubrication Section																									
Wheel	2	1			✓	✓	✓	✓	✓	✓	✓	✓	✓	✓	✓	✓	✓	✓	✓	✓	✓	✓	✓	✓	✓
Spindle	1	3			✓	✓	✓	✓	✓	✓	✓	✓	✓	✓	✓	✓	✓	✓	✓	✓	✓	✓	✓	✓	✓
Hitch Arm Pivot	2	^			✓	✓	✓	✓	✓	✓	✓	✓	✓	✓	✓	✓	✓	✓	✓	✓	✓	✓	✓	✓	✓
Drive Shaft Bearing	2	1			✓	✓	✓	✓	✓	✓	✓	✓	✓	✓	✓	✓	✓	✓	✓	✓	✓	✓	✓	✓	✓
Inspection																									
Inspect for Loose, Missing, or Worn Components				✓																					
Inspect the Belts and Pulleys				✓																					
Inspect the Blades and Blade Mounting Bolts (Torque to 540 N•m (400 ft-lb))				✓																					
Inspect the Blade Carrier Frame Bolts (Torque to 138 N•m (102 ft-lb))				✓																					
Check the Hitch Pivot Bolts (Torque to 205 N•m (151 ft-lb))																									
Inspect the Safety Decals				✓																					

^Grease until fresh grease is visible.

SPECIFICATIONS

Dimensions

Overall Height	51 cm (20 inches)
Overall Length	178 cm (70 inches)
Overall Width	132 cm (52 inches)
Weight	249.5 kg (550 pounds)
Cutting Width	122 cm (48 inches)
Cutting Height	7.6 cm (3 inches) or 12.7 cm (5 inches)

Features

- Heavy duty deck construction.
- Rear discharge deck design.
- Flip up deck design.
- Heavy duty break-away mower blades.