



## OPERATOR'S MANUAL

# VENTRAC 4200

Serial # 2929-



Revised 06/11/14  
09.10051 Rev. 02



328 East Water St.  
 PO Box 148  
 Orrville Oh 44667  
 www.ventrac.com

**To the Owner  
 Contact Information and Product Identification**

*If you need to contact an authorized Ventrac dealer for information on servicing your product, always provide the product model and serial numbers.*

*Please fill in the following information for future reference. See the picture(s) below to find the location of the identification numbers. Record them in the spaces provided.*

Date of Purchase: \_\_\_\_\_

Dealer: \_\_\_\_\_

Dealer Address: \_\_\_\_\_

Dealer Phone Number: \_\_\_\_\_

Dealer Fax Number: \_\_\_\_\_

Model # (A): \_\_\_\_\_  
 Serial # (B): \_\_\_\_\_

Affix Part/Serial Number label here.

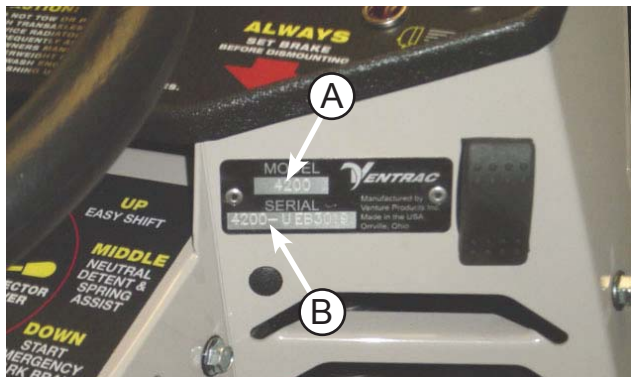

Engine Serial # (C): \_\_\_\_\_

Vanguard

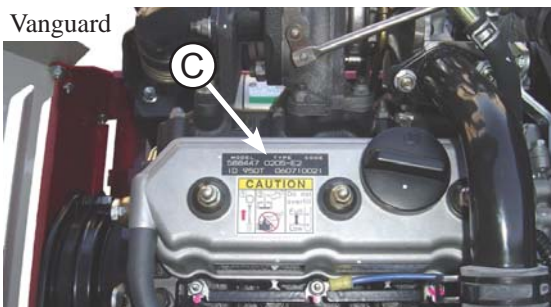

Kawasaki

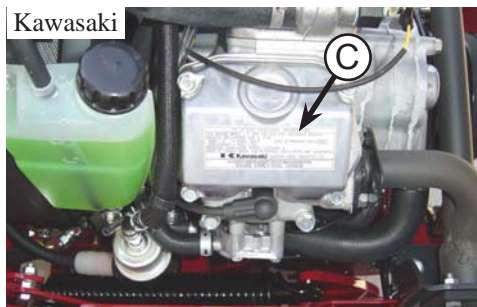

Venture Products Inc. reserves the right to make changes in design or specifications without obligation to make like changes on previously manufactured products.



Venture Products Inc. is pleased to provide you with your new Ventrac! We hope that Ventrac equipment will provide you with a ONE Tractor Solution.

Listed below are just some of the items that can provide you *versatility* as you use your 4200. Please visit our web site, or contact your authorized Ventrac dealer for a complete list of items available for your new power unit.

Accessories	Item Description	Part Number	Accessories	Item Description	Part Number
	Three Point Hitch	70.4063		Light Bar	70.4030
	Dual Wheels (All Terrain Tires)	70.4067		Rear Counter Weight Bar	39.56116
	Dual Wheels (Turf Tires)	70.4068		Rear Bumper	70.4045
	Dual Wheels (Bar Tires)	70.4069		Slope Gauge Indicator	70.0109
	Canopy	70.0098		12V Rear (4 Pin Socket & Power Outlet)	70.4087
	Fold Down ROPS Roll Bar	70.2004		Front 12 Volt Switch & Plug	70.4039
	Suspension Seat	47.0231		Backup Alarm	70.4083
	Foot Pedal	39.56108		Electric PTO Remote	70.4078
	Wheel Extensions	70.4098		Two -N-One Front Hitch	70.2001
	Cab	70.2006		ES220 Spreader	39.55500
	SS300 Salt Spreader	70.2011		SS575 Salt Spreader	70.2010

Attachments	Item Description	Part Number	Attachments	Item Description	Part Number
	Aerator with Open Spoon Tine	39.55490		Stump Grinder	39.55300
	Aerator with Slitter/Slicer Tine	39.55492		Terra Rake - 52"	39.55431
	Aerator with Coring Tine	39.55494		Tiller	39.55220
	AeraVator (seeder kit available)	39.55460		Tough Cut Mower - 68"	39.55104
	Blade - 48"	39.55251		Trencher	39.55455
	Blade - 60"	39.55252		Turbine Blower	39.55340
	Blade - 72"	39.55253		V-Blade	39.55271
	Blower	39.55440		Versa-Loader	39.55600
	Broom	39.55400		Reel Mower - 74"	39.55130
	Edger	39.55330		Rear Discharge Mower - 60"	39.55120
	Excavator - 30"	39.55236		Contour Mower - 84"	39.55160
	Excavator - 48"	39.55230		Collection Vacuum	39.55360
	Finish Mower - 60"	39.55105			
	Finish Mower - 72"	39.55106			
	Finish Mower - 72" (6-1/2" offset)	39.55107			
	Generator - 15,000 Watt	39.55315			
	Power Rake	39.55435			
	Slip Scoop - 30"	39.55216			
	Slip Scoop - 48"	39.55210			
Snow Blower	39.55427				
Sod Cutter	39.55520				

# TABLE OF CONTENTS

<b>INTRODUCTION</b>	<b>PAGE 7</b>
Product Description.....	7
Why do I need an Operator's Manual? .....	7
Using Your Manual.....	8
Manual Glossary .....	8
<b>SAFETY</b>	<b>PAGE 9</b>
Safety Decals.....	9
General Safety Procedures.....	11
Training Required.....	11
Personal Protective Equipment Requirements .....	11
Operating Safely .....	11
Preventing Accidents.....	12
Keep Riders Off.....	12
Operating On Slopes.....	13
Roadway Safety .....	13
Truck Or Trailer Transport.....	13
Maintenance.....	14
Fuel Safety .....	14
Hydraulic Safety .....	15
Roll-Over Protective Structure .....	16
Operator Interlock Systems.....	17
<b>OPERATIONAL CONTROLS</b>	<b>PAGE 18</b>
Operational Control Locations.....	19
Power Take Off (PTO) Switch (A).....	19
Ignition Key Switch (B).....	19
Throttle (C).....	19
Glow Plug Indicator Light (D) .....	19
Tachometer & Hour Meter (E).....	19
Volt Gauge (F).....	19
Engine Coolant Temperature Gauge (G) .....	19
Engine Oil Pressure Warning Light (H).....	20
Seat Belt Light (I) .....	20
Light Switch (J).....	20
12 Volt Switches (K & L).....	20
Engine Coolant High Temp Alarm (M).....	20
Choke (N).....	20
Selector Lever/Parking Brake (O) .....	20
Belt Tension Lever (P).....	20
Front Hitch Latch Lever (Q).....	20
Front Hitch Lock (R).....	20
Seat Slide Adjustment Lever (S).....	20
High/Low Range Shift Handle (T) .....	21
Fuel Primer Bulb Pump (W) .....	21
S.D.L.A. Lever (X & Y) .....	21
Foot Pedal (Z) .....	21
12 Volt Rear Outlet & 4-Pin Socket (AA).....	21

# TABLE OF CONTENTS

## OPERATIONAL CONTROLS (CONT.)

Auxiliary Hydraulic Quick Couplers (EE).....	21
12 Volt 4-Pin Socket (FF).....	22
Electric PTO Remote (5-Pin Socket) (GG).....	22
Seat Latch (HH) .....	22
Seat Prop (II).....	22
Seat Lock Lever (JJ).....	22

## GENERAL OPERATION

**PAGE 23**

Daily Inspection.....	23
Starting the Engine.....	23
Forward and Reverse.....	23
Stopping the Power Unit .....	24
Detaching .....	24
Operating Attachments.....	24
Front Hitch.....	24
PTO Drive Belt & Pulley .....	24
Front Auxiliary Couplers .....	25
Weight Transfer.....	25
High/Low Range.....	25
Turning Radius .....	26
3 Point Hitch (Optional Accessory).....	26
12 Volt Auxiliary Outlets (Optional Accessory) .....	26
Operating On Slopes.....	26
Towing or Pushing the Power Unit .....	27

## SERVICE

**PAGE 28**

Cleaning & General Maintenance .....	28
Service & Maintenance .....	28
Lubrication Locations .....	29
Checking Hydraulic Oil Level .....	30
Checking Rear Transaxle Oil .....	30
Changing Hydraulic Oil and Filter .....	30
Servicing Closed Loop Hydrostatic Drive Circuit.....	30
Checking Engine RPM.....	31
Checking Engine Oil Level.....	31
Changing Engine Oil and Filter .....	31
Servicing Air Filter Elements .....	32
Filling the Fuel Tank .....	33
Servicing Fuel Filter .....	34
Checking Alternator Belt (Vanguard Engines) .....	35
Servicing battery .....	36
Removing and Installing Battery .....	36
Cleaning Battery and Terminals .....	36
Using a Booster Battery .....	37
Changing the Headlight Bulb .....	37
Changing the Taillights .....	38

# TABLE OF CONTENTS

---

## SERVICE (CONT.)

Changing the Fuses .....	38
Servicing Cooling System .....	39
Checking Cooling System .....	39
Cleaning Radiator and Screen .....	39
Draining Cooling System.....	40
Flushing the Cooling System .....	40
Inspection of PTO Belt .....	41
PTO Belt Replacement .....	41
Parking Brake Adjustment.....	42
Neutral Adjustment.....	42
Recommended Tire Pressure .....	42

## MAINTENANCE CHART

**PAGE 43**

Maintenance Schedule - Ventrac 4200 power unit with Kawasaki engine .....	43
Maintenance Checklist - Ventrac 4200 power unit with Kawasaki engine .....	44
Maintenance Schedule - Ventrac 4200 power unit with Vanguard 3LC engine .....	45
Maintenance Checklist - Ventrac 4200 power unit with Vanguard 3LC engine.....	46

## TROUBLESHOOTING

**PAGE 47**

Engine .....	47
Electrical.....	48
Hydraulic .....	49
Power unit .....	49

## SPECIFICATIONS

**PAGE 50**

Electrical.....	50
Power Train .....	50
Controls & instrument Panel .....	50
Other features .....	50
Dimensions .....	51
Fluid Capacities .....	51

## WARRANTY

**PAGE 52**



# INTRODUCTION

---

## Product Description

- The 4200 is a unique *all-wheel-drive* power unit that distributes its weight to four equal sized flotation tires for excellent control, traction, stability, maneuvering, and braking.
- Performance is enhanced by a sturdy, articulated chassis which oscillates to conform to ground contour and turns with ease via hydraulic power steering.
- The hydrostatic transmission drive is controlled with Ventrac's patented S.D.L.A. control, which is located next to the operator, allowing for easy control of Speed, Direction, Lift, and Auxiliary functions with one hand.
- The high/low range selector lever enables the operator to shift both transaxles between high and low range with a single lever.
- The 4200 is equipped with the quick and efficient Ventrac Mount System. This allows you to attach over 30 commercial grade attachments in about a minute or less and requires no tools.

## Why do I need an Operator's Manual?

This manual has been created to help you gain the important knowledge of what is needed to safely operate, maintain, and service your power unit. It is divided into sections for convenient reference of the appropriate section.

You must read and understand the operator's manual for each piece of Ventrac equipment you own. Reading the operator's manual will help you become familiar with each specific piece of equipment. Understanding the operator's manual will help you, as well as others, avoid personal injury and/or damage to the equipment. Keep this manual with the power unit at all times. Store the manual in the manual holder located in the storage box to the right of the operator's seat. The manual should remain with the power unit even if it is sold. If this manual becomes damaged or unreadable, it should be replaced immediately. Contact your local Ventrac dealer for a replacement.

When using a Ventrac attachment, be sure to read and follow the safety and operating instructions of both the power unit and the attachment being used to ensure the safest operation possible.

The information in this manual provides the operator with the safest procedures to operate the power unit while getting the maximum use out of the unit. Failure to follow the safety precautions listed in this manual may result in personal injury and/or damage to the equipment.

# INTRODUCTION

---

## Using Your Manual

Throughout this manual, you will encounter special messages and symbols that identify potential safety concerns to help you as well as others avoid personal injury or damage to the equipment.

### SYMBOL DEFINITIONS



#### **ATTENTION**

This symbol identifies potential health and safety hazards. It marks safety precautions. Your safety and the safety of others is involved.

There are three signal words that describe the level of safety concern: Danger, Warning, and Caution. Safety should always be the #1 priority when working on or operating equipment. Accidents are more likely to occur when proper operating procedures are not followed or inexperienced operators are involved.

Note: Right-Hand and Left-Hand orientations may be referred to at different places throughout this manual. Right-Hand and Left-Hand is determined as if sitting on the power unit seat facing forward.

### SIGNAL WORD DEFINITIONS

#### **⚠ DANGER**

Indicates an imminently hazardous situation which, if not avoided, will result in death or serious injury. This signal word is limited to the most extreme cases.

#### **⚠ WARNING**

Indicates a potentially hazardous situation which, if not avoided, could result in death or serious injury.

#### **⚠ CAUTION**

Indicates a potentially hazardous situation which, if not avoided, may result in minor or moderate injury and/or property damage. It may also be used to alert against unsafe practices.

## Manual Glossary

- Power Unit** A Ventrac tractor or other Ventrac engine powered device that may be operated by itself or with an attachment or accessory.
- Attachment** A piece of Ventrac equipment that requires a Power Unit for operation.
- Accessory** A device that attaches to a Power Unit or Attachment to extend its capabilities.
- Machine** Describes any "Attachment" or "Accessory" that is used in conjunction with a power unit.



# SAFETY

## Safety Decals

The following safety decals must be maintained on your Ventrac 4200 power unit.

Keep all safety decals legible. Remove all grease, dirt, and debris from safety decals and instructional labels. If any decals are faded, illegible, or missing, contact your dealer promptly for replacements.

When new components are installed, be sure that current safety decals are affixed to the replacement components.

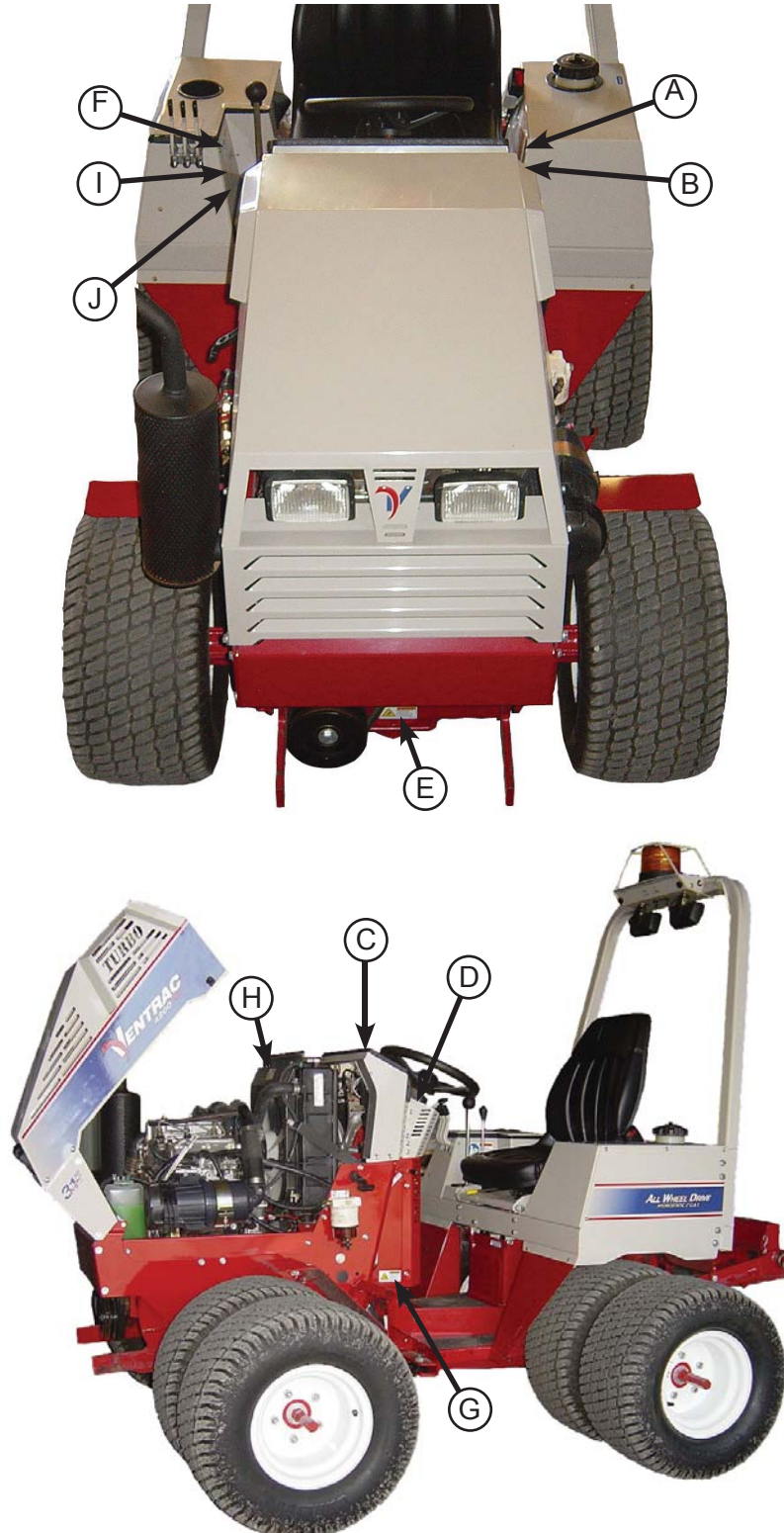

# SAFETY

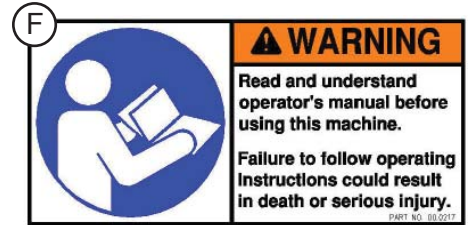
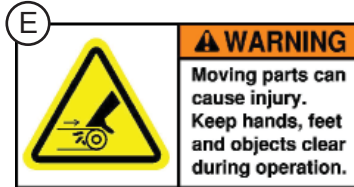
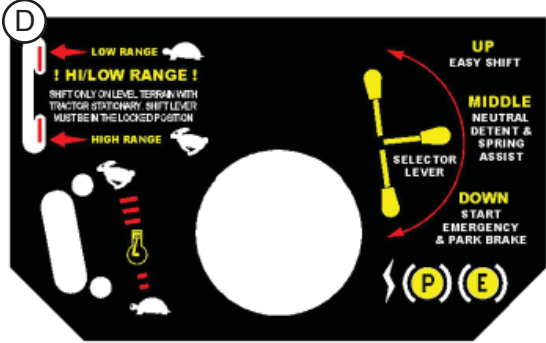
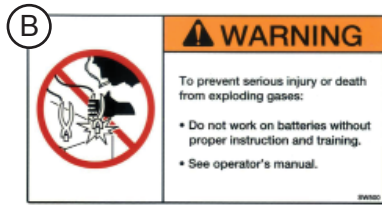

Decal	Description	Part Number	Quantity
A	Danger, Explosion Hazard	00.0121	1
B	Warning - Battery Gases	00.0124	1
C	Upper Dash - General Safety	00.0175	1
D	Lower Dash - High/Low Shift Safety	00.0176	1
E	Warning - Moving Parts	00.0216	1
F	Warning - Read Owners Manual	00.0217	1
G	Warning - Pinching Points	00.0218	2
H	Warning - Avoid Injury	00.0219	1
I	Warning - Safety Alteration	00.0220	1
J	Warning - Hearing PPE	00.0291	1

# SAFETY



## General Safety Procedures for Ventrac Power Units, Attachments, & Accessories



### Training Required

- The owner of this machine is solely responsible for properly training the operators.
- The owner/operator is solely responsible for the operation of this machine and prevention of accidents or injuries occurring to him/herself, other people, or property.
- Do not allow operation or service by children or untrained personnel. Local regulations may restrict the age of the operator.
- Before operating this machine, read the operator's manual and understand its contents.
- If the operator of the machine cannot understand this manual, then it is the responsibility of this machine's owner to fully explain the material within this manual to the operator.
- Learn and understand the use of all controls.
- Know how to stop the power unit and all attachments quickly in the event of an emergency.



### Personal Protective Equipment Requirements

It is the responsibility of the owner to be sure that the operators use the proper personal protective equipment while operating the machine. Required personal protective equipment includes, but is not limited to, the following list.



- Wear a certified ear protection device to prevent loss of hearing.
- Prevent eye injury by wearing safety glasses while operating the machine.
- Closed toe shoes must be worn at all times.
- Long pants must be worn at all times.
- When operating in dusty conditions, it is recommended that a dust mask be worn.

### Operating Safely

- Inspect machine before operation. Repair or replace any damaged, worn, or missing parts. Be sure guards and shields are in proper working condition and are secured in place. Make all necessary adjustments before operating machine.
- Some pictures in this manual may show shields or covers opened or removed in order to clearly illustrate any instructions. Under no circumstance should the machine be operated without these devices in place.
- Alterations or modifications to this machine can reduce safety and could cause damage to the machine. Do not alter safety devices or operate with shields or covers removed.
- Before each use, verify that all controls function properly and inspect all safety devices. Do not operate if controls or safety devices are not in proper working condition.
- Check parking brake function before operating. Repair or adjust parking brake if necessary.
- Observe and follow all safety decals.
- All controls are to be operated from the operator's seat only.
- Always wear a seat belt if the machine has a roll cage/bar installed.
- Ensure the attachment or accessory is locked or fastened securely to the power unit before operating.
- Ensure that all bystanders are clear of the power unit and attachment before operating. Stop machine if someone enters your work area.
- Always be alert to what is happening around you, but do not lose focus on the task you are performing. Always look in the direction the machine is moving.
- Look behind and down before backing up to be sure of a clear path.
- If you hit an object, stop and inspect the machine. Make all necessary repairs before operating machine again.
- Stop operation immediately at any sign of equipment failure. An unusual noise can be a warning of equipment failure or a sign that maintenance is required. Make all necessary repairs before operating machine again.

# SAFETY



## General Safety Procedures for Ventrac Tractors, Attachments, & Accessories



### Operating Safely (continued)

- If equipped with a high/low range feature, never shift between high and low range while on a slope. Always move the machine to level ground and place the selector lever in park before shifting range.
- Do not leave machine unattended while it is running.
- Always park the machine on level ground.
- Always shut off engine when connecting attachment drive belt to the power unit.
- Never leave the operator's seat without lowering the attachment to the ground, setting the parking brake, shutting off the engine, and removing the ignition key. Make sure all moving parts have come to a complete stop before dismounting.
- Never leave equipment unattended without lowering the attachment to the ground, setting the parking brake, shutting off the engine, and removing the ignition key.
- Only operate in well-lit conditions.
- Do not operate when there is a risk of lightning.
- Never direct the discharge of any attachment in the direction of people, buildings, animals, vehicles, or other objects of value.
- Never discharge material against a wall or obstruction. Material may ricochet back towards the operator.
- Use extra caution when approaching blind corners, shrubs, trees, or other objects that may obscure vision.
- Do not run the engine in a building without adequate ventilation.
- Do not touch the engine or the muffler while the engine is running or immediately after stopping the engine. These areas may be hot enough to cause a burn.
- Do not change the engine governor settings or over-speed the engine. Operating engine at excessive speed may increase the hazard of personal injury.
- To reduce the hazard of fire, keep the battery compartment, engine, and muffler areas free of grass, leaves, and excessive grease.

### Preventing Accidents



- Clear working area of objects that might be hit or thrown from machine.
- Keep people and pets out of mowing area.
- Know the work area well before operation. Do not operate where traction or stability is questionable.
- Reduce speed when you are operating over rough ground.
- Equipment can cause serious injury and/or death when improperly used. Before operating, know and understand the operation and safety of the power unit and the attachment being used.
- Do not operate machine if you are not in good physical and mental health, if you will be distracted by personal devices, or are under the influence of any substance which might impair decision, dexterity, or judgment.
- Children are attracted to machine activity. Be aware of children and do not allow them in the working area. Turn off the machine if a child enters the work area.



### Keep Riders Off

- Only allow the operator on the power unit. Keep riders off.
- Never allow riders on any attachment or accessory.



# SAFETY



## General Safety Procedures for Ventrac Tractors, Attachments, & Accessories



### Operating On Slopes

- Slopes can cause loss-of-control and tip-over accidents, which can result in severe injury or death. Be familiar with the emergency parking brake, along with the power unit controls and their functions.
- If power unit is equipped with a fold down roll bar, it must be locked in the upright position when operating on any slope.
- Use low range (if equipped) when operating on slopes greater than 15 degrees.
- Do not stop or start suddenly when operating on slopes.
- Never shift between high and low range while on a slope. Always move the power unit to level ground and engage the parking brake before shifting range or placing the power unit in neutral.
- Variables such as wet surface and loose ground will reduce the degree of safety. Do not drive where machine could lose traction or tip over.
- Keep alert for hidden hazards in the terrain.
- Stay away from drop-offs, ditches, and embankments.
- Sharp turns should be avoided when operating on slopes.
- Pulling loads on hills decreases safety. It is the responsibility of the owner/operator to determine loads that can safely be controlled on slopes.
- Transport machine with attachment lowered or close to the ground to improve stability.
- While operating on slopes, drive in an up and down direction when possible. If turning is necessary while driving across slopes, reduce speed and turn slowly in the downhill direction.
- Assure a sufficient supply of fuel for continuous operation. A minimum of one-half tank of fuel is recommended.

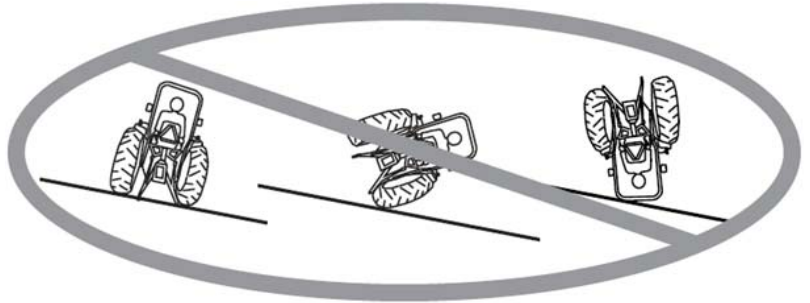

### Roadway Safety

- Operate with safety lights when operating on or near roadways.
- Obey all state and local laws concerning operation on roadways.
- Slow down and be careful of traffic when operating near or crossing roadways. Stop before crossing roads or sidewalks. Use care when approaching areas or objects that may obscure vision.
- If there is doubt of safety conditions, discontinue machine operation until a time when operation can be performed safely.
- When operating near or on roadways, have a Slow Moving Vehicle Emblem clearly displayed.



### Truck Or Trailer Transport

- Use care when loading or unloading machine into a truck or trailer.
- The parking brake is not sufficient to lock the machine during transport. Always secure the power unit and/or attachment to the transporting vehicle.
- Shut off fuel supply to power unit during transport on truck or trailer.
- If equipped, turn the battery disconnect switch to the Off position to shut off electrical power.

# SAFETY



## General Safety Procedures for Ventrac Tractors, Attachments, & Accessories



### Maintenance

- Keep all safety decals legible. Remove all grease dirt, and debris from safety decals and instructional labels.
- If any decals are faded, illegible, or missing, contact your dealer promptly for replacements.
- When new components are installed, be sure that current safety decals are affixed to the replacement components.
- If any component requires replacement, use only original Ventrac replacement parts.
- Always disconnect the negative battery cable from the battery when working with electrical components.
- Keep all bolts, nuts, screws, and other fasteners properly tightened.
- Always lower the attachment to the ground, engage parking brake, shut off engine, and remove the ignition key. Make sure all moving parts have come to a complete stop before cleaning, inspection, adjusting or repairing.
- If the power unit, attachment, or accessory requires repairs or adjustments not instructed in the operator's manual, the power unit, attachment, or accessory must be taken to an authorized Ventrac dealer for service.
- Never perform maintenance on the power unit and/or attachment if someone is sitting in the operator's seat.
- Always use protective glasses when handling the battery.
- Check all fuel lines for tightness and wear on a regular basis. Tighten or repair them as needed.
- To reduce the hazard of fire, keep the battery compartment, engine, and muffler areas free of grass, leaves, and excessive grease.
- Do not touch the engine or the muffler while the engine is running or immediately after stopping the engine. These areas may be hot enough to cause a burn.
- Do not change the engine governor settings or over-speed the engine. Operating engine at excessive speed may increase the hazard of personal injury.
- Springs may contain stored energy. Use caution when disengaging or removing springs and/or spring loaded components.
- An obstruction or blockage in a drive system or moving/rotating parts may cause a buildup of stored energy. When the obstruction or blockage is removed, the drive system or moving/rotating parts may move suddenly. Do not attempt to remove an obstruction or blockage with your hands. Keep hands, feet, and clothing away from all power-driven parts.
- Dispose of all fluids in accordance with local laws.

### Fuel Safety



- Do not refuel machine while smoking or at a location near flames or sparks.
- Always refuel the machine outdoors.
- Do not store machine or fuel container indoors where fumes or fuel can reach an open flame, spark, or pilot light.
- Only store fuel in an approved container. Keep out of reach of children.
- Never remove fuel cap or add fuel with the engine running. Allow engine to cool before refueling.
- Never remove fuel cap while on a slope. Only remove when parked on a level surface.
- Replace all fuel tank and container caps securely.
- Do not overfill fuel tank. Only fill to bottom of fuel neck, do not fill fuel neck full. Overfilling of fuel tank could result in engine flooding or fuel leakage from the tank.
- If fuel is spilled, do not attempt to start the engine. Move the power unit away from the fuel spill and avoid creating any source of ignition until fuel vapors have dissipated.
- If the fuel tank must be drained, it should be drained outdoors into an approved container.
- Dispose of all fluids in accordance with local laws.
- Check all fuel lines for tightness and wear on a regular basis. Tighten or repair them as needed.
- The fuel system is equipped with a shut-off valve. Shut off the fuel when transporting the machine to and from the job, when parking the machine indoors, or when servicing the fuel system.



# SAFETY



## General Safety Procedures for Ventrac Tractors, Attachments, & Accessories



### Hydraulic Safety

- Make sure all hydraulic connections are tight and all hydraulic hoses and tubes are in good condition. Repair any leaks and replace any damaged or deteriorated hoses or tubes before starting the machine.
- Hydraulic leaks can occur under high pressure. Hydraulic leaks require special care and attention.
- Use a piece of cardboard and a magnifying glass to locate suspected hydraulic leaks.



- Keep body and hands away from pinhole leaks or nozzles that eject high pressure hydraulic fluid. Hydraulic fluid escaping under high pressure can penetrate the skin causing serious injury. If hydraulic fluid is injected into skin, seek immediate medical attention.

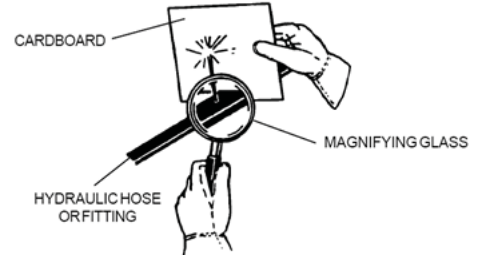

- Hydraulic system may contain stored energy. Before performing maintenance or repairs on the hydraulic system, remove attachments, engage parking brake, disengage weight transfer system (if equipped), shut off engine, and remove ignition key. To relieve pressure on the auxiliary hydraulic system, shut off the power unit engine and move the secondary S.D.L.A. lever left and right before disconnecting the auxiliary hydraulic quick couplers.
- Dispose of all fluids in accordance with local laws.

# SAFETY

---



## KT4200 Safety Procedures



- Weight transfer springs may contain stored energy. Always disengage the weight transfer system before performing maintenance or repairs on the weight transfer system, the front hitch, or the lift hydraulics.
- Power unit hydraulic system may contain stored energy. Before performing maintenance or repairs on the attachment hydraulic system, remove attachments, engage parking brake, disengage weight transfer system, shut off engine, and remove ignition key.

### **WARNING**

The engine exhaust from this product contains chemicals known to the State of California to cause cancer, birth defects or other reproductive harm.

### **CALIFORNIA PROPOSITION 65 Diesel Exhaust Warning**

Diesel engine exhaust and some of its constituents are known to the State of California to cause cancer, birth defects or other reproductive harm.

### **CALIFORNIA PROPOSITION 65 Battery Warning**

Battery posts, terminals, and related accessories contain lead and lead compounds, chemicals known to the State of California to cause cancer and reproductive harm. Wash hands after handling!

## Roll-Over Protective Structure

Your power unit is equipped with a Roll-Over Protective Structure (ROPS).

- Certified seat belt anchor: #OSHA 1928.51.
- Certified ROPS, roll bar: #OSHA 1928.52.
- Certified ROPS, fold down roll bar: #OSHA 1928-51.
- Fold down ROPS must be fixed in the upright position during operation.
- Always wear the seat belt during operation. Never jump from the power unit.
- During operation, the seat belt indicator light on the dash will turn on if the seat belt is not fastened. The seat belt indicator light will turn off if the seat belt is fastened.
- If damaged, the roll bar or seat belt must be replaced before operation.

### **WARNING**

Alterations or modifications to this machine can reduce safety and could cause damage to the machine. Do not alter safety devices or operate with shields or covers removed.

# SAFETY



## KT4200 Safety Procedures



### Operator Interlock Systems

The operator interlock systems:

- prevent the engine from starting unless the selector lever is in the park position.
- prevent the PTO clutch from engaging unless the operator is present on the seat and activates the PTO.
- Deactivates the PTO if the operator leaves the seat.
- prevents the power unit from moving unless the parking brake is released and the operator is present on the seat.

Park the power unit on a level surface. Lower attachment to the ground and turn off power unit engine. Chock tires to prevent rolling. Ensure the operating area is free of obstacles and bystanders.

Perform the following tests:

- The Ignition Circuit
  - Sit on the seat.
  - Place the power unit's selector lever in the park position. Turn key to 'start'. Starter should engage.
  - Place the power unit's selector lever in the neutral assist position. Turn key to 'start'. Starter should NOT engage.
- The PTO Circuit - Operator Presence
  - Sit on the seat.
  - Turn the ignition key to the 'run' position. (Do not start the engine for this test.)
  - Press top portion of the PTO switch to activate the PTO. The PTO clutch should audibly engage.
  - Rise off the seat. The PTO clutch should audibly disengage.
  - Return to the seat with the PTO switch still activated. The PTO clutch should NOT engage.
  - Turn the key to the 'off' position.
  - Press the bottom portion of the PTO switch to turn the switch off.
- The PTO Circuit - Operator Interlock
  - Sit on the seat.
  - With the key in the off position, press the top portion of the PTO switch to activate the PTO. The PTO clutch should NOT engage.
  - With the PTO switch still in the on position, turn the key switch to the on position. The PTO clutch should NOT engage.
  - Press the bottom portion of the PTO switch to turn the switch off.
  - Press top portion of the PTO switch to activate the PTO. The PTO clutch should audibly engage.
- S.D.L.A. Control Lever - Operator Presence
  - Sit on the seat.
  - Place the power unit's selector lever in the easy shift position.
  - Rise off the seat and simulate forward/reverse motion by attempting to move the S.D.L.A. control lever forward and rearward. S.D.L.A. control lever should NOT move forward and rearward.

Place the power unit's selector lever in the park position and remove the wheel chocks.

- S.D.L.A. Control Lever - Parking Brake
  - Sit on the seat.
  - Start the power unit engine.
  - With the selector lever still in the park position, move the S.D.L.A. control lever forward and rearward. The S.D.L.A. control lever should move forward and rearward, but the power unit should NOT move.
  - Place the power unit's selector lever in the neutral assist position.
  - Slowly move the S.D.L.A. control lever forward and rearward. The power unit should drive according to the input of the S.D.L.A. control lever.

If any test fails, do not operate. Repair before operating.

### WARNING

Alterations or modifications to this machine can reduce safety and could cause damage to the machine. Do not alter safety devices or operate with shields or covers removed.



# OPERATIONAL CONTROLS

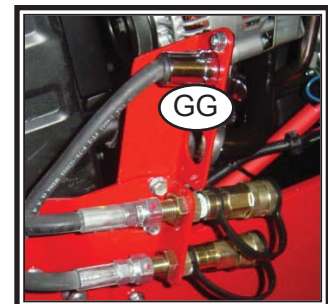
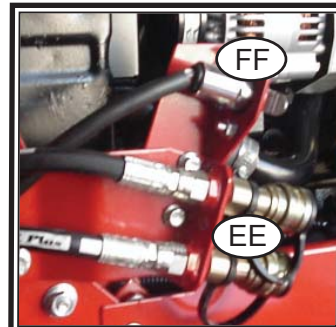
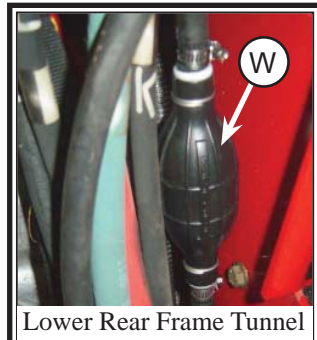
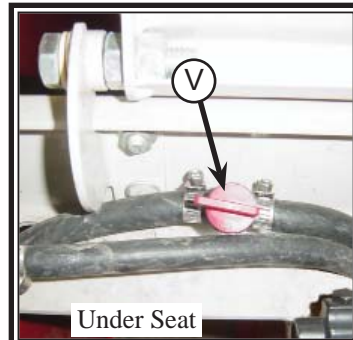
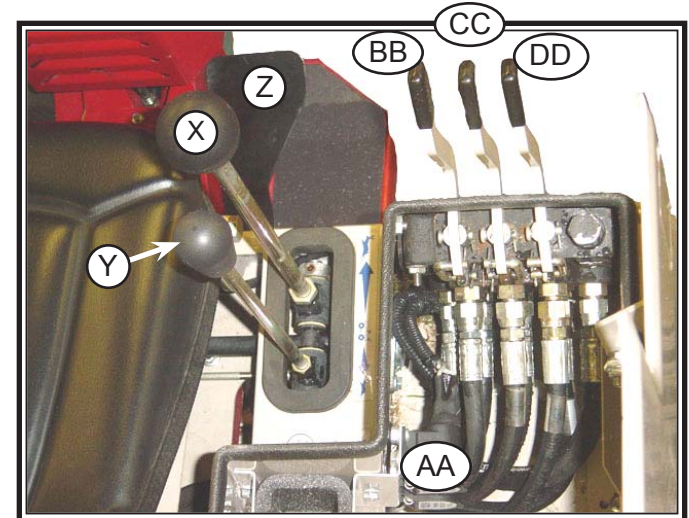
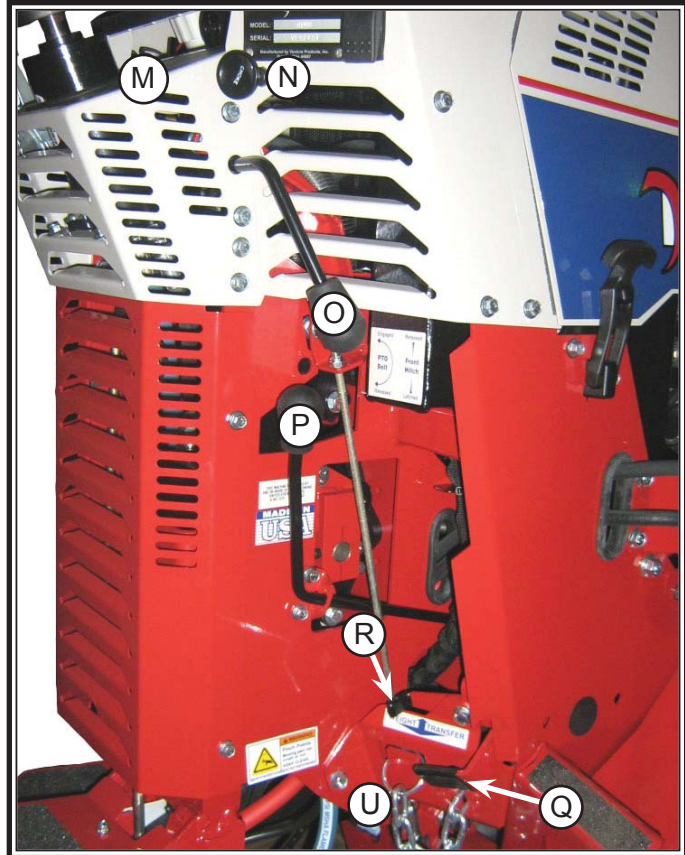
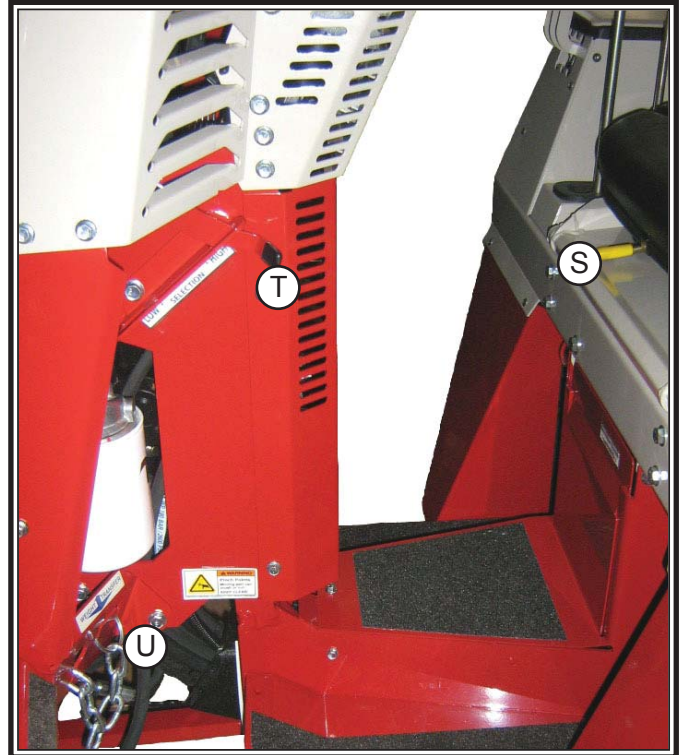

# OPERATIONAL CONTROLS

## OPERATIONAL CONTROL LOCATIONS

The images on the previous page match with reference letters as shown below to help identify the locations of operational controls for this power unit.

**A - PTO Switch**

**B - Ignition Key Switch**

**C - Throttle**

**D - Glow Plug Indicator Light\***

**E - Tachometer/Hour Meter**

**F - Volt Gauge**

**G - Engine Coolant Temperature Gauge**

**H - Engine Oil Pressure Warning Light**

**I - Seat Belt Light**

**J - Light Switch**

**K - 12 Volt Switch (On/Off)\*\***

**L - 12 Volt Switch (Momentary On/Off/On)\*\***

**M - Engine Coolant High Temperature Alarm**

**N - Choke\*\*\***

**O - Selector Lever/Parking Brake**

**P - Belt Tension Lever**

**Q - Front Hitch Latch Lever**

**R - Front Hitch Lock**

**S - Seat Slide Adjustment Lever**

**T - High/Low Range Shift Handle**

**U - Weight Transfer**

**V - Fuel Shut-off Valve**

**W - Fuel Primer Bulb Pump\***

**X - Primary S.D.L.A. Control**

**Y - Secondary S.D.L.A. Control**

**Z - Foot Pedal\*\***

**AA - 12 Volt Rear Outlet & 4-Pin Socket\*\***

**BB - 3pt Hitch Control Handle\*\***

**CC - Left Rear Auxiliary Hydraulics Handle\*\***

**DD - Right Rear Auxiliary Hydraulics Handle\*\***

**EE - Auxiliary Hydraulic Quick Couplers**

**FF - 12 Volt 4-Pin Socket\*\***

**GG - Electric PTO Remote (5-Pin Socket)\*\***

**HH - Seat Latch (See page 18)**

**II - Seat Prop (See page 18)**

**JJ - Seat Lock Lever\*\* (See page 18)**

\* Diesel Models

\*\* Optional Equipment

\*\*\* Gasoline Models

## POWER TAKE OFF (PTO) SWITCH (A)

Depressing the top of the PTO switch engages the electric clutch to provide power to the front attachment. Depressing the bottom part of the switch will disengage the clutch and apply the clutch brake to stop the attachment. Note: The PTO will shut off automatically if the operator leaves the power unit seat. To restart, first return to the seat, then disengage and re-engage the PTO switch.

## IGNITION KEY SWITCH (B)

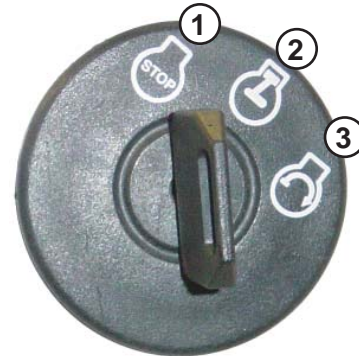

1. Off or Stop Position - All 12 volt power going through the key switch is off.
2. On or Run Position - Engine run position.
3. Start - When key is turned to the start position, starter will engage.

## THROTTLE (C)

Moving the lever forward increases the engine Revolutions Per Minute (RPM). Moving it back slows the engine to an idle.

## GLOW PLUG INDICATOR LIGHT (D)

Indicates activation of glow plugs for preheating the engine (diesel models only). The glow plugs activate when the key is turned to the on position. When the glow plug light turns off, the engine is ready to start. The glow plugs and glow plug light are activated when the key switch is in the start position, and remain activated for 15-20 seconds after start up.

## TACHOMETER & HOUR METER (E)

When the engine is running, the engine RPM and engine run time in hours is displayed.

## VOLT GAUGE (F)

Displays the voltage level of the charging system.

## ENGINE COOLANT TEMPERATURE GAUGE (G)

Displays the temperature of the engine cooling system.



# OPERATIONAL CONTROLS

## ENGINE OIL PRESSURE WARNING LIGHT (H)

Signifies low or no engine oil pressure.

## SEAT BELT LIGHT (I)

Light indicates when seat belt is not in use. When seat belt is fastened, the light will turn off.

## LIGHT SWITCH (J)

Depressing the top of the switch will turn on the headlights, the taillights, and the backlighting on the dash gauge(s). Depressing the bottom part of the switch will turn the lights off. Lights only work when the key is in the run or start position.

## 12 VOLT SWITCHES (K & L)

Optional accessory. These switches turn off and on the 12 volt accessories utilized by some attachments.

## ENGINE COOLANT HIGH TEMP ALARM (M)

**(Vanguard engines only)** Alarm sounds when the engine coolant temperature exceeds 240°. Refer to troubleshooting section for possible symptoms.

## CHOKE (N)

**(Gasoline models only)** Pulling the choke handle out aids in starting a cold engine.

## SELECTOR LEVER/PARKING BRAKE (O)

Position #1: Park/Start Position. In this position, the park brake is applied, and the S.D.L.A. control lever is locked out. The lever must be in this position to start.

Position #2: Neutral Assist Position. In this position, the parking brake and the S.D.L.A. control lever are released. If an operator is present on the seat, the power unit can now be operated. In the neutral assist position, the S.D.L.A. control lever has a “spring assist to neutral” action. This position makes neutral easy to select and maintain. Neutral assist is recommended when learning the operation of your Ventrac, loading & unloading, attaching and removing attachments, and whenever the operator is working in tight areas or is unsure of the power unit’s response to the task being performed.

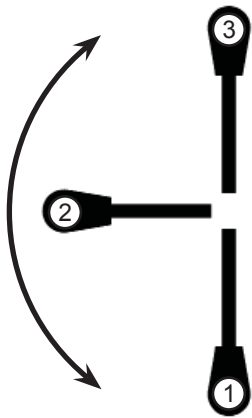

Position #3: Easy shift position. In this position, the S.D.L.A. control lever is in an “easy shift” mode. This position is designed for experienced operators for operation of the power unit in open areas where travel speed and direction are relatively constant and control is easily maintained. Easy shift reduces operator arm fatigue when using the power unit for prolonged periods of time.

**⚠ CAUTION**

Stopping in this position requires the operator to return the S.D.L.A. control or foot pedal to the neutral position.

## BELT TENSION LEVER (P)



Rotating the belt tension lever up until it locks applies tension to the attachment drive belt. Rotating the belt tension lever down releases the tension of the attachment drive belt, allowing the operator to remove or install the attachment drive belt.

## FRONT HITCH LATCH LEVER (Q)

The front hitch latch handle engages or disengages the hitch latch for attaching or detaching Ventrac attachments. Raise the handle to open the hitch latch. Lower the handle and ensure the handle is secured in the notch to close the hitch latch.

## FRONT HITCH LOCK (R)

The front hitch lock prevents the accidental release of the front hitch latch lever. To release, lift the tab of the front hitch lock and raise the front hitch latch handle.

## SEAT SLIDE ADJUSTMENT LEVER (S)

Move lever outward to release lock. Slide the seat to desired location and release lever.



# OPERATIONAL CONTROLS

## High/Low Range Shift Handle (T)

### CAUTION

Never shift while under load, while moving, or while on a slope. Always ensure the shift handle is secured in the lock position at the end of each shift stroke.

The high/low range shift handle shifts both the front and rear transaxles simultaneously. With the power unit parked on level ground, push the shift handle forward to select low range. Pull the shift handle back to select high range. Ensure the shift handle is secured in the lock position at the end of each shift stroke.

## Weight Transfer (U)

The weight transfer system allows the operator to select the amount of weight transferred from the front mounted attachment to the front drive wheels of the power unit. Transferring weight from the attachment to the power unit improves traction & hillside stability, aids in lifting, reduces steering effort, and lessens the attachment resistance when in contact with the ground. Note: The weight transfer system is only active while the primary S.D.L.A. is in the float position.

The weight transfer chains determine the amount of weight being transferred from the attachment to the front wheels of the power unit. If no chain links are outside the weight transfer plate, no weight will be transferred from the attachment. The more chain links outside the weight transfer plate, the more weight will be transferred from the attachment.

## Fuel Shut-off Valve (V)

The fuel shut-off valve controls the flow of fuel to the power unit engine. It can be turned off to prevent fuel leakage when changing fuel filters or servicing fuel system.

## Fuel Primer Bulb Pump (W)

The fuel primer bulb pump is used to prime the fuel system on diesel models if there has been an interruption in the fuel flow to the engine.

## S.D.L.A. Lever (X & Y)

### (Speed, Direction, Lift, and Auxiliary Control Levers)

The S.D.L.A. is the primary control for the power unit and consists of two parts: The primary lever (X) controls the Speed, Direction of power unit & Lift of the hitch arms. The secondary lever (Y) controls the Auxiliary hydraulic circuit.

**S** – Speed: The amount of forward or backward movement of this lever controls the ground speed of the power unit.

**D** - Direction: The forward or backward movement of the lever controls the direction of the power unit.

**L** – Lift: The lift function of the lever has four positions: Up, Hold, Down, and Float Lock. “Hold” is the default position; this holds the lift arms from moving up or down. Pulling the lever to the left raises the hitch arms. Pushing the lever to the right lowers the hitch arms. Float position is attained by pushing the lever to the right until the float detent locks the lever in place.

**A** - Auxiliary: The left or right movement of the secondary lever controls the functions of attachments that require the auxiliary hydraulic circuit. An optional float kit (part # 23.0111-7) is available for the auxiliary circuit.

## Foot Pedal (Z)

Optional accessory. The foot pedal works in conjunction with the S.D.L.A. lever and can be used to control direction and speed when the operator’s hand is removed from the S.D.L.A. lever.

## 12 Volt Rear Outlet & 4-Pin Socket (AA)

Optional accessory. The outlet provides 12 volts of electrical power for a variety of products such as cell phones, radios, spot lights, air compressors, and more. The socket provides electrical power to rear mounted attachments equipped with electrical controls. (e.g. ES220 Spreader.)

## 3 Point Hitch & Rear Auxiliary Control Handles (BB, CC, & DD)

Optional accessory. The left control handle (BB) raises or lowers the 3 point hitch arms. The middle control handle (CC) controls the left rear set of hydraulic quick couplers. The right control handle (DD) controls the right rear set of quick couplers.

## Auxiliary Hydraulic Quick Couplers (EE)

The two couplers are a part of the auxiliary hydraulic circuit and are used with an attachment which requires hydraulics (e.g. to angle a dozer blade or rotate the discharge on the snow blower).

# OPERATIONAL CONTROLS

## 12 VOLT 4-PIN SOCKET (FF)

Optional accessory. The socket is controlled by the 12 volt switches and provides electrical power to attachments equipped with electrical controls. (e.g. broom rotation actuator, snowblower discharge chute angle, etc.)

## ELECTRIC PTO REMOTE (5-PIN SOCKET) (GG)

Optional accessory. The 5-pin socket is used with attachments equipped with a remote PTO switch, such as the HG150 generator, allowing the operator to shut off the power unit PTO from the attachment.

## SEAT LATCH (HH)

The seat latch (A) secures the standard seat during transport.

To release, pull the latch away from the seat plate while lifting up on the seat.

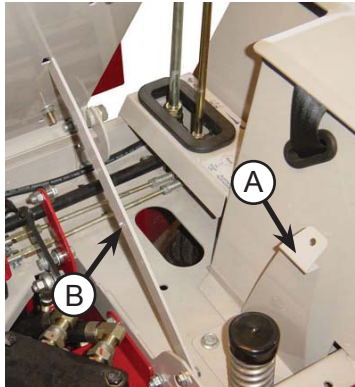

## SEAT PROP (II)

The seat prop (B) secures the seat in the tipped forward position while service is performed under the seat.

To secure, tip the seat forward, lift up the seat prop, and insert the end into the wide portion of the seat plate slot. Move the seat prop to the narrow portion of the slot to prevent accidental release.

To release, move the seat prop to the wide portion of the slot. Tip the seat forward while guiding the seat prop out of the slot. Lower the seat prop back into the seat box.

## SEAT LOCK LEVER (JJ)

The seat lock lever is included with the optional suspension seat kit. It secures the suspension seat during transport. It can also replace the standard seat latch.

Engage the seat lock lever by lifting up until it locks in the upright position. Disengage the seat lock lever by pushing it down alongside the seat.



The seat lock lever must be disengaged prior to operation.

# GENERAL OPERATION

## DAILY INSPECTION

### ⚠ WARNING

Always set the parking brake, shut off the power unit engine, remove the ignition key, and ensure all moving parts have stopped before checking mower deck or blade condition, or attempting any repair or adjustment.

1. Park the power unit on a level surface, with the engine shut off and all fluids cold.
2. Perform a visual inspection of the power unit. Look for loose or missing hardware, damaged components, or signs of wear. Inspect hydraulic hoses, hydraulic fittings, and fuel lines to ensure tight, leak free connections. Check belts for damage or excessive wear.
3. Check the power unit's engine oil, hydraulic oil, cooling system, tire pressure, and fuel level. Add fluid or service system as required.
4. Test the operator safety interlock system.

## STARTING THE ENGINE

The 4200 is equipped with an interlock system for your safety. The following procedure is to be followed to start the power unit:

1. The interlock system requires the "Selector Lever" to be in the park position, the S.D.L.A. lever to be in the neutral position, and the PTO switch to be turned off.
2. Move the throttle forward approximately  $\frac{1}{4}$  of its travel.
3. **Gasoline Engines:** Pull out choke handle to the on position. Choke may not be required when the engine is at operating temperature. **Diesel Engines:** Turn key clockwise to the on or run position. The engine uses glow plugs to preheat the combustion chamber. The blue glow plug indicator light will come on indicating the glow plugs are preheating. When the glow plug indicator light goes out, the engine is ready to start and must be started within a few seconds or glow plug preheating cycle may need repeated. No preheat is required when the engine is at operating temperature.
4. Turn the key to the start position and hold to engage starter. Release key when engine starts. Note: If engine fails to start, refer to troubleshooting section.
5. The engine and hydraulic oil must be warmed to

operating temperature before operations. Allow the unit to run at approximately 1800 rpm until the hydraulic filter is warm to touch. The hydraulic filter is located just above the left weight transfer control chain.

### ⚠ CAUTION

Allow time for the hydraulic oil to circulate before the power unit is operated. Severe damage could result to the hydraulic system if adequate warm up isn't allowed. Warm up time is increased in colder weather.

## FORWARD AND REVERSE

Verify that the intended path is safe and free from obstacles. When safe to move, begin by moving the selector lever into either the neutral assist position or the easy shift position.

Power unit movement is controlled by moving the S.D.L.A. control lever in the desired direction of travel. Push the S.D.L.A. control lever forward to move power unit in the forward direction. Pull the S.D.L.A. control lever backward to make the power unit move in the reverse direction. Changing the amount the S.D.L.A. control lever is moved instantly changes the ground speed of the power unit. Moving it one half of the stroke will result in approximately one half of the maximum ground speed. Moving it to the end of the stroke will result in maximum ground speed.

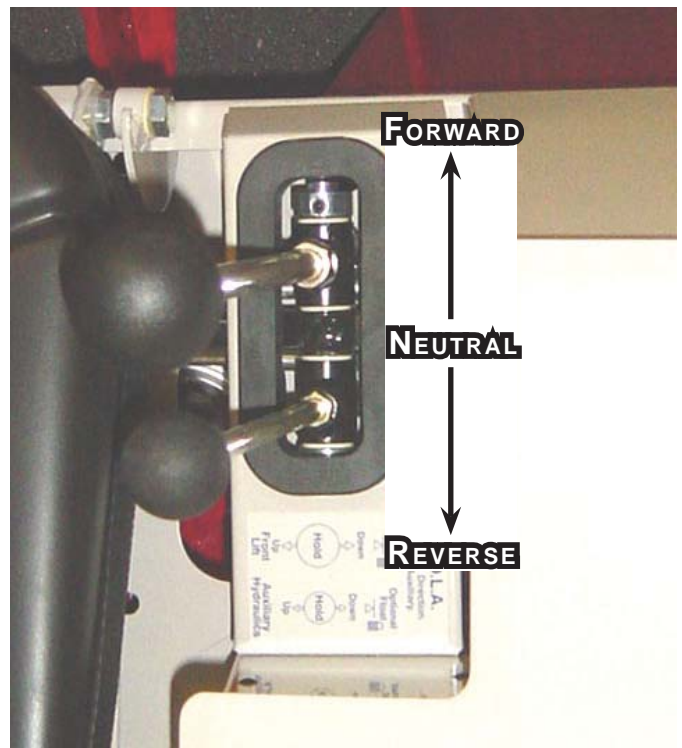

# GENERAL OPERATION

## STOPPING THE POWER UNIT

To slow or stop the power unit, move the S.D.L.A. control lever in the opposite direction that you are traveling. Return the S.D.L.A. control lever to the neutral position to make a complete stop. A foot pedal brake is not required because you use the S.D.L.A. control lever to stop the power unit. If in the case of an emergency and the power unit cannot be stopped with the S.D.L.A. control lever, move the selector lever to the park position to stop the power unit.

### ⚠ CAUTION

If the selector lever is placed in the park position in the case of an emergency, the power unit will come to an abrupt stop.

## ATTACHING

1. Drive the power unit slowly forward into the hitch arms on the attachment. Align the lift arms of the power unit with the attachment hitch arms by raising or lowering the front hitch to complete the engagement.
2. Once completely engaged, move the front hitch latch lever to the closed position.
3. Engage the parking brake and shut off the engine.
4. Place the attachment belt over the front groove of the PTO drive pulley on the power unit. Ensure the belt is properly seated in each pulley.\*
5. Engage the PTO belt tension lever.\*
6. Clean the quick couplers and connect to the auxiliary hydraulics.\*
7. Connect the electric plug to the matching socket on the power unit.\*

\*Applies only if attachment is equipped.

## DETACHING

1. Park the power unit on a level surface and move the selector lever to the park position.
2. Fully raise attachment and set weight transfer to the off position.
3. Lower the attachment to the ground and place the primary S.D.L.A. lever in the float position.
4. Shut off engine.
5. Disengage the PTO belt tension lever.\*
6. Remove the attachment belt from the PTO drive pulley of the power unit.\*

7. Move the secondary S.D.L.A. lever left and right to release pressure from the auxiliary hydraulic circuit and disconnect the hydraulic quick couplers from the power unit.\*
8. Disconnect the electric plug from the socket on the power unit.\*
9. Disengage the front hitch latch lever.
10. Restart power unit and slowly back away from the attachment.

\*Applies only if attachment is equipped.

## OPERATING ATTACHMENTS

Refer to the attachment's manual for the proper operation and use of the particular attachment that is being operated.

## FRONT HITCH

The front hitch is used to secure attachments to power unit, and to raise and lower the attachment. The front hitch is controlled by the primary S.D.L.A. lever. Pull the lever to the left to raise the attachment, push the S.D.L.A. lever to the right to lower the attachment. The primary S.D.L.A. is equipped with a 'float' position. Push the S.D.L.A. lever to the far right position until the float detent engages and stays in place to operate in float.

## PTO DRIVE BELT & PULLEY

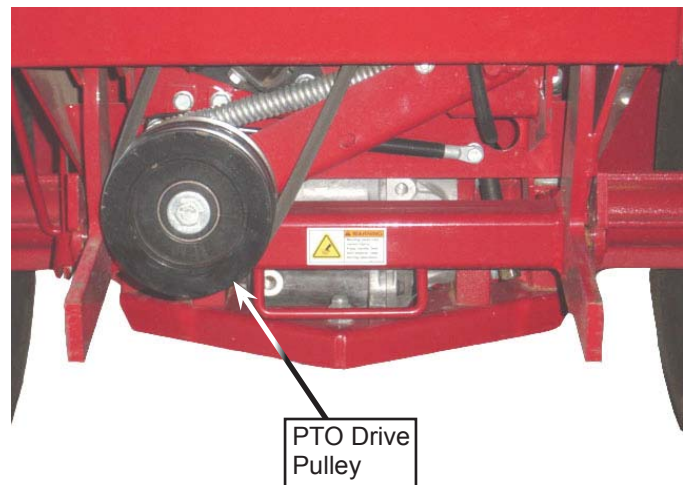

If the attachment requires a drive belt, release the belt tension lever and install the attachment belt around the drive pulley at the location shown above. When the belt is in place around the drive pulley, rotate the belt tension lever up to tighten the belt.

Engage the PTO by depressing the top of the PTO switch. Note: PTO will engage only if operator is present on the seat.



# GENERAL OPERATION

## FRONT AUXILIARY COUPLERS

### ⚠ CAUTION

#### EQUIPMENT DAMAGE!

Dirt and other debris in hydraulic system can cause damage to the system. Wipe clean the mating parts of the couplers before coupling. Use protective rubber plugs over hydraulic couplers when not in use.

If attachment requires auxiliary hydraulics, couple the attachment hoses with the front auxiliary couplers. This is done by sliding the collar of the coupler rearward and inserting the end of the attachment hose into the coupler and releasing the collar. If the collar will not snap forward on its own, pull it forward manually.

The couplers that the hoses are attached to will affect which way the secondary S.D.L.A. lever is pushed to control the action of the attachment. If the hoses are connected and the action is not the desired motion, then switch the hoses the couplers are attached to. Auxiliary couplers are controlled by moving the secondary S.D.L.A. lever left or right.

NOTE: Pressure build-up in the attachment hose and on the power unit couplers may occur, causing difficult installation of hoses. If hoses do not easily connect, try one or both of the following steps: 1) To release the pressure from power unit couplers, turn off engine and move the secondary lever of the S.D.L.A. right and left to release pressure in the power unit's hydraulic circuit. 2) To release pressure in the attachment hose, loosen one of the hose ends, tighten when pressure is released.

## WEIGHT TRANSFER

The weight transfer system transfers weight from the attachment to the front wheels of the power unit. The operator can select different transfer rates by adjusting the right and left weight transfer chains.

To set the weight transfer, raise the front hitch to its maximum height.

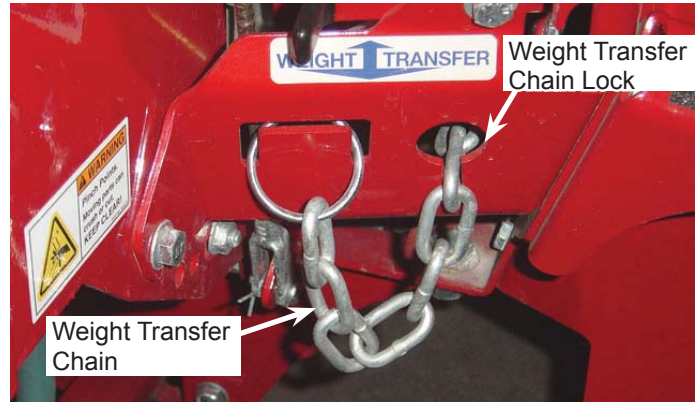

Lift the weight transfer chain link out of the chain lock slot. Feed the chain back through the hole to decrease amount of transferred weight or pull the chain out through the hole to increase the amount of transferred weight. When the desired setting is reached, insert chain link back in the chain lock slot.

Selecting the proper amount of weight to transfer depends on attachments, ground conditions and operator preference. A lightweight attachment (e.g. KA160 Power Blower) will not go down with full weight transfer on. With full weight transfer on and mowing in the float position, the mower may not come down quickly enough when going through uneven terrain. Weight transfer must be reduced or speed must be lowered.

## HIGH/LOW RANGE

### ⚠ CAUTION

Never shift while under load, while moving, or while on a slope. Always ensure the shift handle is secured in the lock position at the end of each shift stroke.

For slopes greater than 15 degrees, always use low range.

Low range is recommended for most pulling, pushing, and slow travel. High range is ideal for transport and light duty tasks.

Stop the power unit and engage the parking brake. Move the shift lever to the desired range setting. Occasionally engagement of the transaxle gears is prevented by gear misalignment. Moving the steering wheel slightly to the right or left will move the gears enough to complete the engagement.

# GENERAL OPERATION

## TURNING RADIUS

Your power unit has three mounting positions for the steering cylinder that determine the power unit's turning radius.

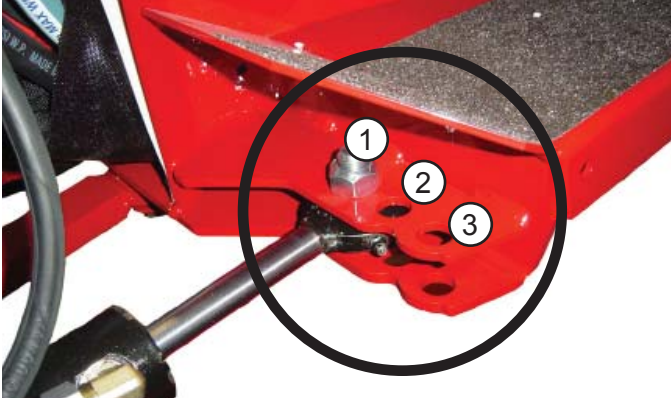

Position #1: Standard position. This position is the standard position, and enables the tightest turning radius.

Position #2: Dual wheel position. The steering cylinder must be installed in this position when operating with dual wheels. The resulting turning radius will be larger than in position #1.

Position #3: Cab and Versa-loader position. The steering cylinder must be installed in this position when the cab is installed or when operating the Versa-loader. The resulting turning radius will be larger than in position #2.

## 3 POINT HITCH (OPTIONAL ACCESSORY)

Some light and medium duty implements (non-PTO powered) can be used on the rear of a 3 point hitch equipped power unit.

The 3 point hitch is equipped with adjustable lift links to control the individual draw bars. The stabilizing links can be allowed to swing freely or can be locked at a desired position.

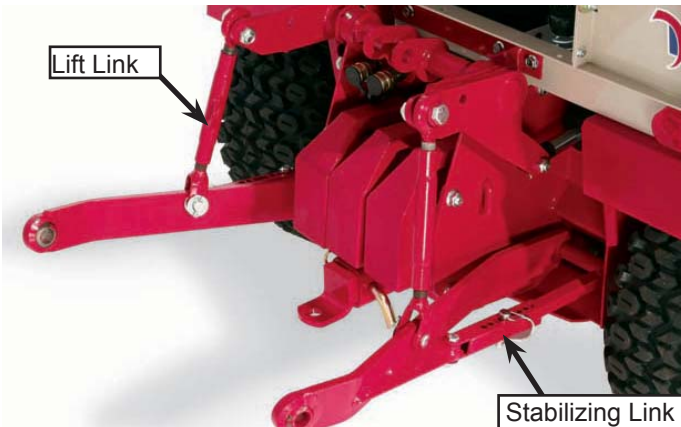

The 3 point hitch is equipped with three control

handles. The inside handle raises and lowers the draw bar. The middle handle controls the left rear set of hydraulic quick couplers. The outside handle controls the right rear set of hydraulic quick couplers.

## 12 VOLT AUXILIARY OUTLETS (OPTIONAL ACCESSORY)

Certain attachments require a 12 volt auxiliary outlet. Plug the attachment's 12 volt power cord into the 12 volt 4-pin plug located above the front auxiliary quick couplers. Two switches are used to control the actions of the 12 volt kit. A momentary on/off/on is used for controlling movement that is only used for a brief time. The on/off switch is used to activate equipment or select different functions.

## OPERATING ON SLOPES

### ⚠ WARNING

#### AVOID PERSONAL INJURY!

Operation on slopes decreases power unit stability and increases the potential for unexpected difficulties. Only experienced operators should operate the power unit on slopes and extra caution should be exercised.

- Use low range when operating on slopes greater than 15 degrees.
- Never shift between high and low range while on a slope. Always move the machine to level ground and place the selector lever in park before shifting range.
- Avoid uneven, loose, or wet terrain.
- Stay clear of drop-offs, holes, ditches, rocks, or objects that could cause a sudden and/or unexpected force on the power unit.
- Make slow and cautious starts, stops, and turns.
- Do not exceed the maximum degree of operation. Refer to illustrations.
- Turn downhill when possible and/or reduce the degree of turns.
- Assure a sufficient supply of fuel for continuous operation. A minimum of one-half tank of fuel is recommended.
- To prevent fuel spillage, do not remove the fuel tank cap while power unit is on a slope.
- Failure to follow items listed or to use common sense while operating on slopes can result in injury or death. Always operate on slopes with caution.



# GENERAL OPERATION

## ⚠ CAUTION

### AVOID ENGINE DAMAGE!

Kawasaki engines and Vanguard gas engines, are rated for a maximum angle of operation of 25° for continuous use (all directions) and 30° for intermittent use.

Vanguard naturally aspirated and turbo diesel engines installed in 4200 power units serial numbers 1001-2380 are rated for a maximum angle of operation of 25° for continuous use (all directions) and 30° for intermittent use.

Vanguard naturally aspirated and turbo diesel engines installed in 4200 power units after serial number 2380 are rated for 30° continuous use.

**Exceeding the engine's rated angle of operation may result in damage to the engine.**

Maintain sufficient fuel in tank to ensure continuous operation.

Cease operation if power unit stability is questionable, or if the operator is uncomfortable or unsure of continuing safely.

Attachments can affect the stability of the power unit. Each attachment will affect the power unit differently.

Increase the amount of weight being transferred to the power unit from the attachment while operating on slopes. See Weight Transfer section.

Always operate carefully and in a manner that does not compromise safety.

Always wear seat belt!

Refer to following illustrations for power unit capability with different equipment options.

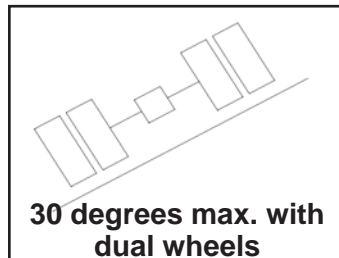
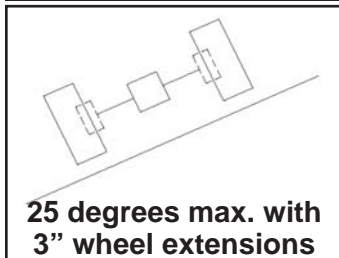
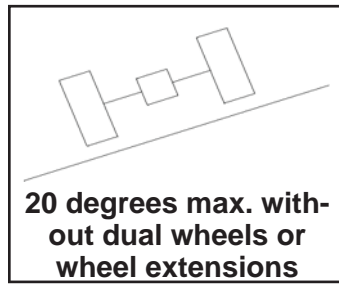
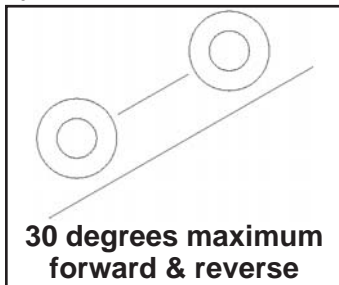

## TOWING OR PUSHING THE POWER UNIT

⚠ **ATTENTION:** Avoid damage to your power unit! Before towing, read and understand the information below. Severe damage will occur to unit if proper towing procedure is not followed.

## ⚠ CAUTION

Failure to place the transaxles in neutral when towing or pushing the power unit may result in damage to the power unit drivetrain.

If the power unit needs to be moved without the engine running, it is important to remember to place the transaxles in neutral by shifting the high/low range shift handle to the middle of the shift stroke. With the transaxles in neutral and the parking brake disengaged, the power unit can freewheel. Use extreme caution when towing or pushing the power unit; steering may not function. Do not exceed 5 mph (8 km/h).

# SERVICE

## ⚠ WARNING

Always set the parking brake, shut off power unit engine, remove the ignition key, and ensure all moving parts have come to a complete stop before inspecting components or attempting any repair or adjustment.



## Attention

If any component requires replacement, use only original Ventrac replacement parts.

## CLEANING & GENERAL MAINTENANCE

For best results, and to maintain the finish of the power unit, clean or wash the power unit to remove accumulated clippings, leaves, dirt, gravel, and salt deposits.



## Attention

To maintain the finish of the power unit, thoroughly wash the equipment after each use to remove any corrosive agents (e.g., salt). Failure to clean the equipment may result in corrosion of (including but not limited to) steel, aluminum, and electrical components. Equipment that will experience repeated exposure to corrosive agents should be pretreated with a corrosion preventative.

## SERVICE & MAINTENANCE

Proper and timely service of this power unit is critical to keep the power unit in a safe and reliable operating condition. Follow the Maintenance Schedule at the end of the service section. For convenience, a Frequent Service Reference Chart has been placed on the power unit under the hood as shown in the picture below.



Throughout the Service Section, different access

points are referred to. Below is a list of shields and covers that may need to be removed or opened during service.

- A - Engine Hood
- B - Pump Cover
- C - Rear Frame Tunnel Cover
- D - Seat Plate

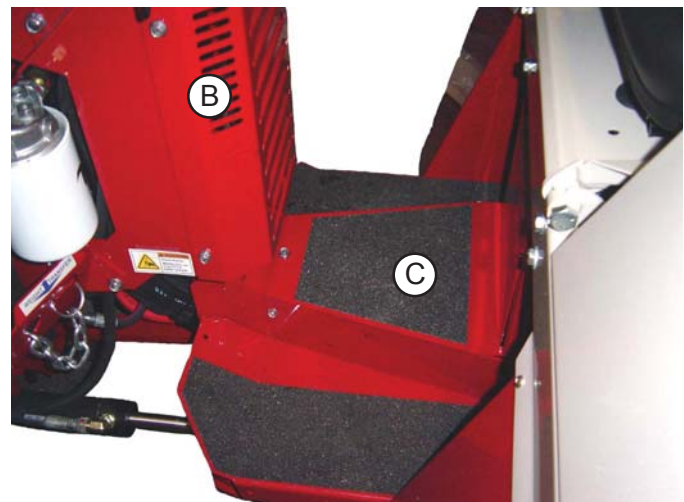
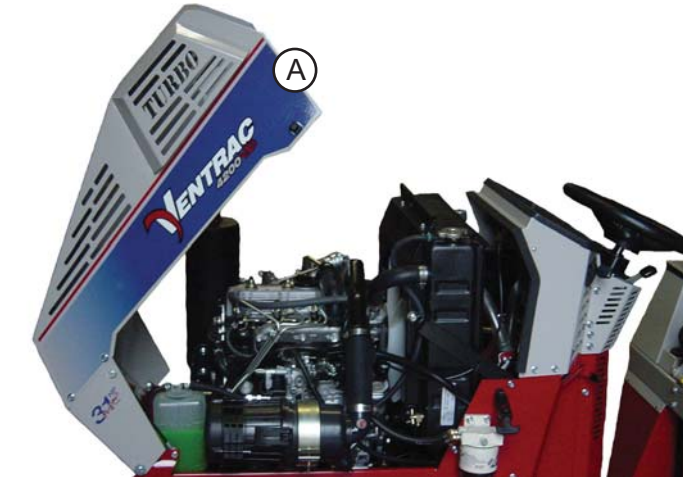



# SERVICE

## LUBRICATION LOCATIONS

Lubrication is required at the following locations. For service intervals, see Maintenance Schedule. When greasing pivot points and bearings, use only one pump of grease.

Steering Cylinder & Connector Link (Front)

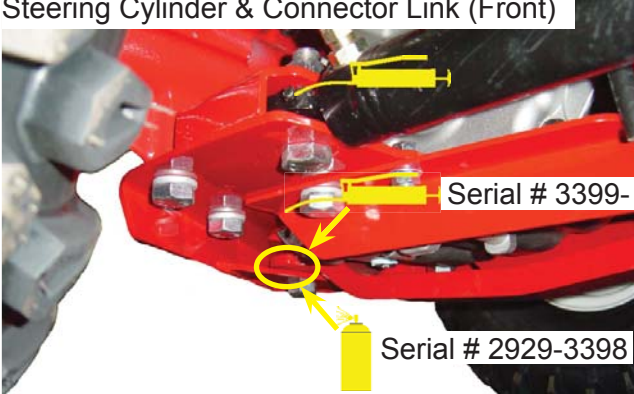

Steering Cylinder & Connector Link (Rear)

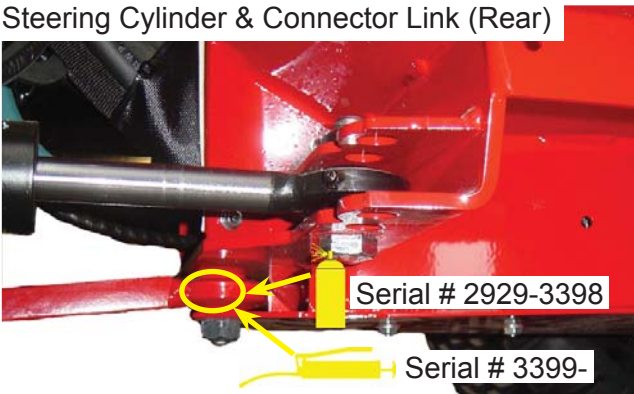

Front Hitch



Lift Cylinder



## Grease

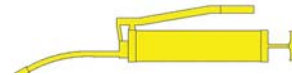

Lithium Complex NLGI #2  
type grease

## Spray Lube



Drive Shaft U-Joint

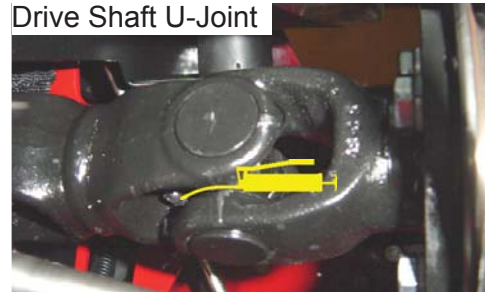

Center Pivot

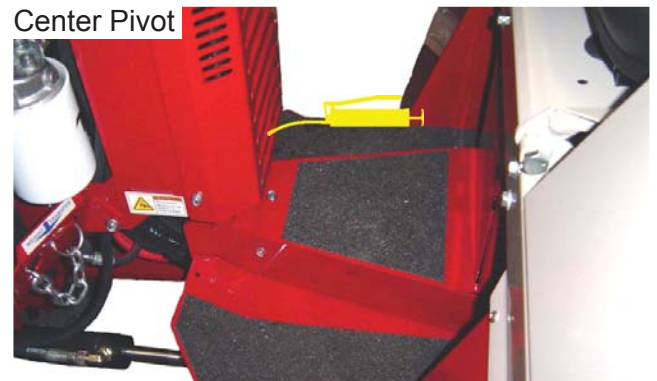

3 Point Hitch Pivot & Cylinder

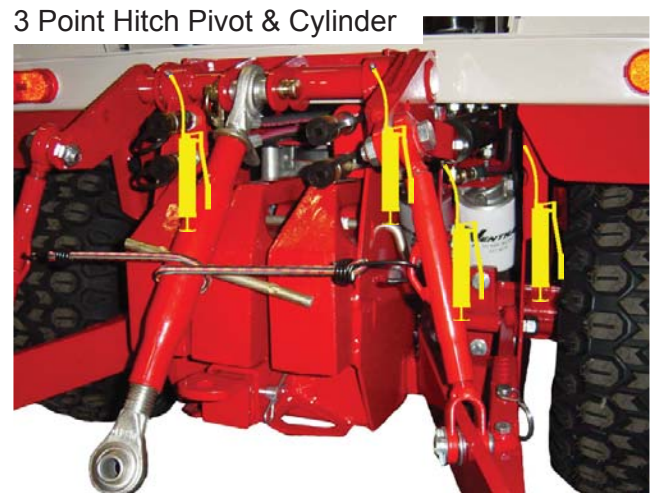

Seat Rails



# SERVICE

## CHECKING HYDRAULIC OIL LEVEL

Check hydraulic oil level before operating unit when the hydraulic system is cold. If the hydraulic system is warm, allow 1 hour for the hydraulic system to cool before checking. If the hydraulic system is warm when the oil level is checked, it will produce an inaccurate oil level reading.

1. Park power unit on a level surface.
2. Engage parking brake and shut off engine.
3. Remove ignition key from switch and allow time for hydraulic system to cool.
4. The hydraulic tank is located under the hood near the right side of the dash as shown. (A)

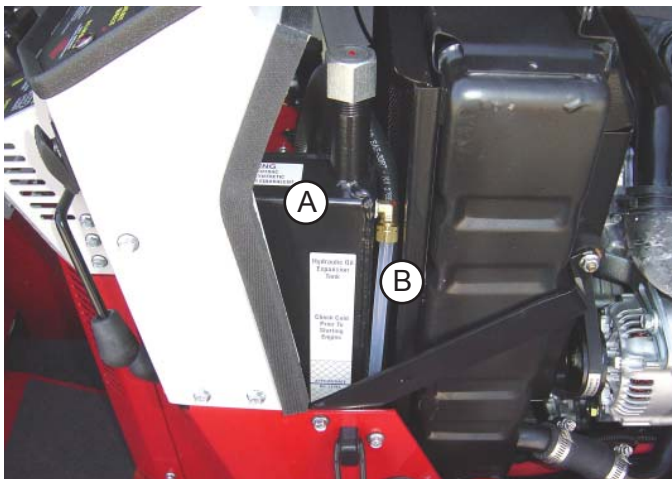

5. Check that the oil level in the plastic sight tube (B) next to the hydraulic tank is within the proper range indicated by the oil level decal.
6. If hydraulic oil level is below the checkered area of the decal, add HydroTorq XL synthetic hydraulic oil until the proper level is reached.

## CHECKING REAR TRANSAXLE OIL

Check the rear transaxle oil level before operating unit when oil is cold.

1. Park power unit on a level surface.
2. Engage parking brake and shut off engine.
3. Remove the oil fill plug from the transaxle and check to see if oil is even with the bottom of the oil fill hole.

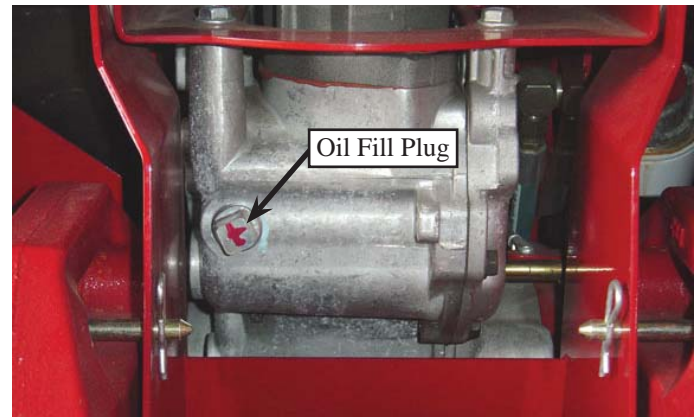

4. If oil level is low, add HydroTorq XL synthetic hydraulic oil until level with bottom of oil fill hole.

## CHANGING HYDRAULIC OIL AND FILTER

Hydraulic oil and filters should be changed at intervals of 2000 hours. Hydraulic oil and filters to be changed by an authorized Ventrac dealer only.

## SERVICING CLOSED LOOP HYDROSTATIC DRIVE CIRCUIT

Service or repair must be performed by an authorized Ventrac dealer.

If any part of the closed loop hydrostatic drive circuit (pump, front drive motor, rear drive motor, or any of the three 1/2" hydraulic lines connecting them together) is serviced or replaced, the Ventrac closed loop drive circuit filtration procedure must be performed. This procedure requires a special Ventrac remote filtering tool and must be performed by a Ventrac authorized technician.

### **⚠ WARNING**

Failure to perform this filtering procedure following a repair can result in component and/or complete system failure and may void warranty.



# SERVICE

## CHECKING ENGINE RPM

Check engine RPM's when engine is warmed up and not under load.

### Observe Tachometer:

- Slow idle (no load) - 1500 +/-50
- Fast idle (no load) - 3600 +/-50

If engine RPM is incorrect, contact your local Ven-trac dealer.

## CHECKING ENGINE OIL LEVEL

**⚠ ATTENTION: Avoid damage to your engine. Failure to check the oil level regularly could lead to serious damage to your engine if the engine is run with an incorrect oil level.**

- Before operation, check engine oil with the unit sitting on a level surface.
- Check oil level when the engine is cold and not running
- Keep oil level between the FULL and ADD marks.
- Shut off engine before adding oil.

1. Park power unit on a level surface.
2. Engage parking brake and shut off engine.
3. Remove ignition key from switch.
4. Open engine hood to access the engine compartment.
5. Remove the dipstick (A) located on the left side of the engine. Wipe dipstick with a clean cloth.

Vanguard Engine



Kawasaki Engine

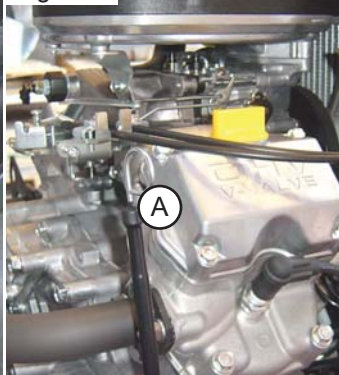

6. Install dipstick back into the engine and remove again.



7. Check oil level. Level should be between the Full (B) and Add (C) on the dipstick.
8. NOTE: if oil is low, add small amounts of oil to bring the oil level no higher than level (B) on the dipstick.
9. If oil level is above (B), drain to achieve proper level.
10. Install dipstick and close hood.

## CHANGING ENGINE OIL AND FILTER

### ⚠ CAUTION

**ENVIRONMENTAL HAZARD!**  
Oil is hazardous to the environment. Dispose of oil in an approved container at a proper recycle center.

1. Run engine for 5 minutes to warm up the oil.
2. Park power unit on a level surface.
3. Engage parking brake and shut off engine.
4. Remove ignition key from switch.
5. Open engine hood to access the oil and oil filter.
6. Place a drain pan under the oil drain located just in front of the front transaxle on the left side (Vanguard) or the right side (Kawasaki).
7. Remove drain cap from oil drain (A).

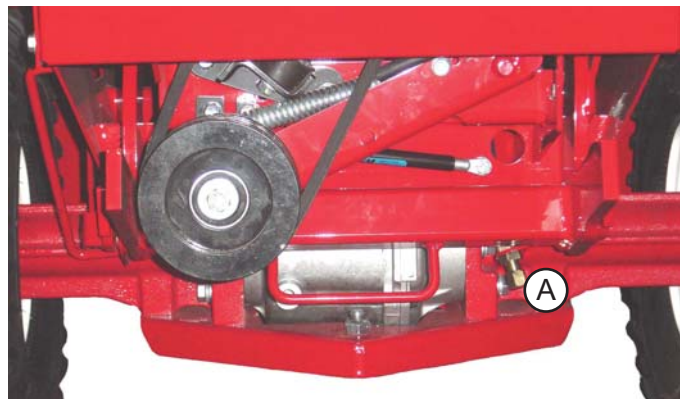

# SERVICE

- Remove oil filter (B) located on the side of the engine. Turn filter counterclockwise to remove.

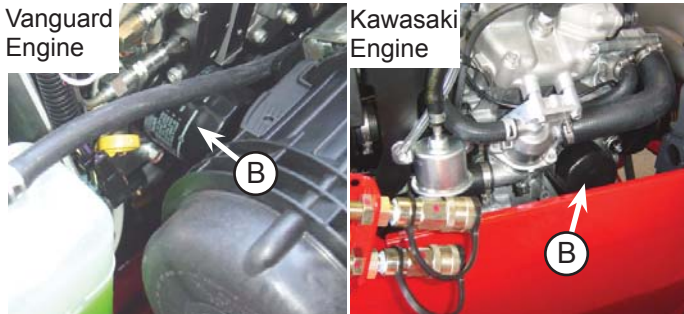

- Wipe the filter mounting surface with a clean cloth.
- Apply a thin film of clean engine oil to gasket of oil filter.
- Install new filter. NOTE: Turn filter clockwise until filter gasket makes contact with the mounting surface. Tighten 1/2 - 3/4 turn after gasket contact.
- Install oil drain cap. DO NOT over-tighten.
- Remove oil fill cap.
- Add oil to engine. (See Engine Owner's Manual for proper oil and capacity)
- Install oil fill cap.
- Start engine and allow to run at slow idle for approximately 2 minutes.
- Shut off engine.
- Remove ignition key from switch.
- Check oil after allowing engine to cool for approximately 2 minutes.
- Refer to "Checking Engine Oil Level" for proper procedures on how to check the oil.

## SERVICING AIR FILTER ELEMENTS

### ⚠ CAUTION

#### AVOID ENGINE DAMAGE!

When removing the air filter element, an opening directly to the internal parts of the engine is created.

Be sure that nothing falls into the canister that could make its way into the engine. Have the new filter element ready to install immediately after the old element has been removed.

**⚠ ATTENTION: Avoid damage to your engine! Improper service to the engine air filter can result in severe engine damage.**

- Inspect filter daily in extreme heat, dust, or other severe conditions.
- Never run engine without proper air filter installed.
- Never wash or clean paper filter element.

## Changing Air Filter Element(s) (Vanguard Engines)

- Park power unit on a level surface.
- Engage parking brake and shut off engine.
- Remove ignition key from switch.
- Allow engine to cool.
- Open engine hood to access engine compartment.
- Release both latches (A) on the canister and unhook latches from the canister housing.

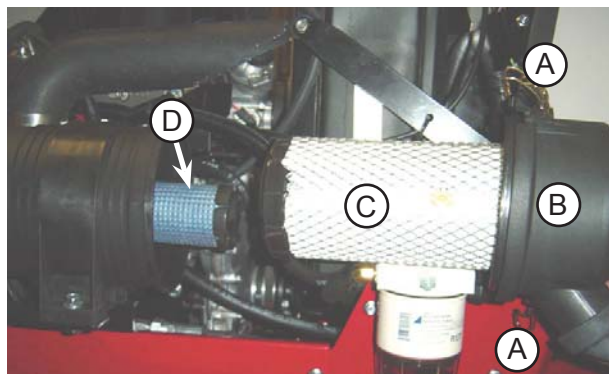

- Remove the air filter cap (B).
- Remove and discard the primary filter element (C).
- If necessary, remove and discard the safety air filter (D). Refer to Maintenance Schedule for safety air filter service interval.



# SERVICE

10. Install the new filter element(s).
11. Reinstall the air canister cap.
12. Close engine hood.

## Cleaning Foam Air Filter Element (Kawasaki Engines)

1. Park power unit on a level surface.
2. Engage parking brake and shut off engine.
3. Remove ignition key from switch.
4. Allow engine to cool.
5. Open engine hood to access engine compartment.
6. Remove the air filter cover.
7. Remove the foam filter element (A).
8. Wash the foam element with detergent and water and dry it thoroughly.

### ⚠ CAUTION

Do not oil foam filter element.

9. Reinstall the foam element over the paper element.
10. Reinstall the air filter cover.
11. Close engine hood.

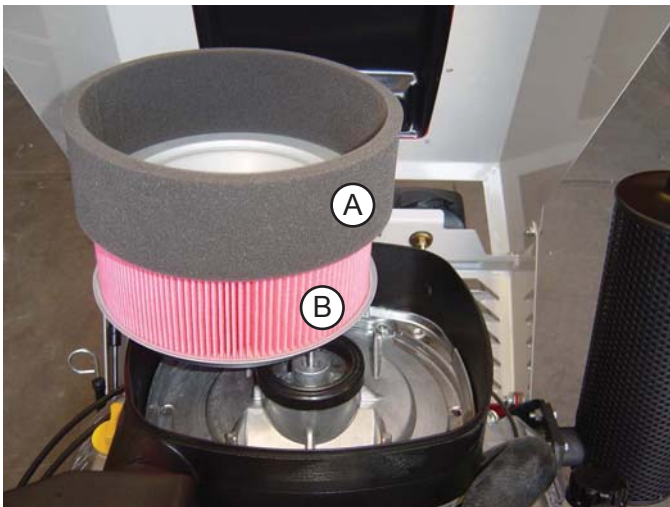

## Cleaning and Replacing Paper Air Filter Element (Kawasaki Engines)

1. Park power unit on a level surface.
2. Engage parking brake and shut off engine.
3. Remove ignition key from switch.
4. Allow engine to cool.
5. Open engine hood to access engine compartment.
6. Remove the air filter cover.

7. Remove the foam filter element.
8. Remove the wing nut and paper filter element (B).
9. Discard paper element, if necessary. Refer to Engine Owner's Manual for proper service intervals.
10. Clean the paper element by tapping gently to remove dust.

### ⚠ CAUTION

Do not wash paper filter element.  
Do not oil foam filter element.  
Do not use pressurized air to clean paper filter element.

11. Install the paper element and wing nut.
12. Reinstall the foam element over the paper element.
13. Reinstall the air filter cover.
14. Close engine hood.

## FILLING THE FUEL TANK

### ⚠ DANGER

Fuel is flammable and/or explosive. Follow all safety instructions in the Fuel Safety section of this manual and in the engine operator's manual.

### ⚠ WARNING

Long term exposure to fuel vapors can cause serious injury or illness. Avoid prolonged breathing of fuel vapors.

If fuel is spilled on skin or clothing, change clothing and wash affected skin immediately.

### ⚠ CAUTION

Avoid damage to your engine!

Only use fuel that meets the specifications required for your engine. Refer to the engine operator's manual for the proper grade and specifications of fuel for your engine.

1. Park the power unit on a level surface.
2. Engage the parking brake and shut off the engine.
3. Remove the key from the ignition switch and allow the engine to cool.
4. The fuel tank cap is located on top of the left rear fender. Wipe any dust and dirt off the fuel cap

# SERVICE

to prevent dirt from falling into the fuel tank, and remove the fuel cap.

5. Add fuel to the tank until the fuel level reaches the bottom of the fuel neck. Do not overfill. Keep the fuel nozzle in contact with the rim of the fuel neck until fueling is completed.
6. Replace the fuel cap and tighten until it clicks.
7. Wipe up any fuels spills and allow fuel vapors to dissipate before starting the engine.

\*If power unit will not be used after filling fuel tank, only fill the tank to within 1" (25 mm) of the bottom of the fuel neck to allow room for fuel expansion from temperature changes. Failure to do so may cause engine flooding.

## SERVICING FUEL FILTER

### **⚠ DANGER**

#### **AVOID PERSONAL INJURY!**

Avoid personal injury and/or death from fumes, fire or explosion when working on fuel related parts:

- Shut off engine and allow to cool.
- Do not smoke anywhere near the power unit.
- Keep power unit away from flames or sparks.
- Work in a well ventilated area.
- Clean up spilled fuel immediately.

### **⚠ CAUTION**

#### **AVOID PERSONAL INJURY!**

Wear proper personal protective equipment to protect eyes and hands when working with the fuel system.

- Let power unit cool before servicing.
- Drain fuel into an approved nonmetallic container.
- Disconnect negative battery cable before working on the fuel system.

## Changing In-line Fuel Filter (Gasoline Engines)

1. Turn the fuel shut-off valve to the OFF position.
2. Remove the rear frame tunnel cover (Vanguard gas only).
3. Locate the fuel filter inside the rear frame tunnel area (Vanguard) or at the right base of the engine (Kawasaki).
4. Loosen the hose clamps and remove the fuel filter.
5. Install the new filter with the flow arrow pointing toward the engine.
6. Reinstall the tunnel cover (Vanguard gas only).
7. Turn the fuel shut-off valve to the ON position.

## Fuel Filter/Water Separator (Diesel Engines)

Water and sediment can be observed through the glass bowl on the bottom of the filter.

1. Drain water through the valve (A).
2. Remove sediments through the plug opening (B).

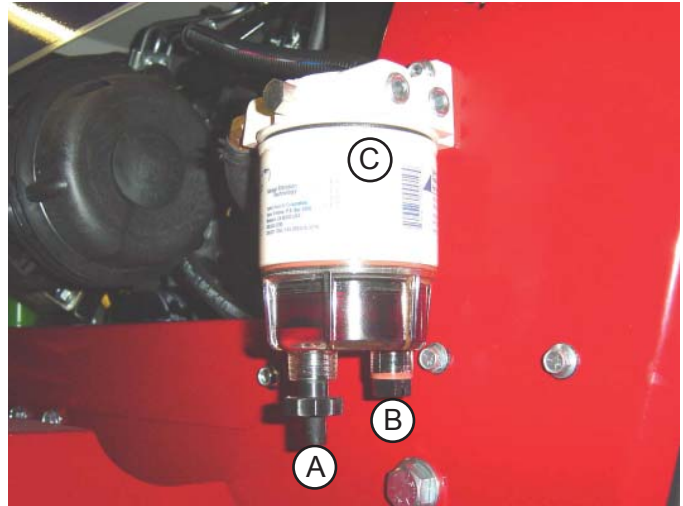

## Changing the Fuel Filter (Diesel Engines)

1. Turn the fuel shut-off valve to the OFF position.
2. Remove the fuel filter canister (C).
3. Replace the filter element.
4. Reinstall the fuel filter canister.
5. Turn the fuel shut-off valve to the ON position.
6. Prime the fuel system, if necessary.

## Priming the Fuel System (Gasoline Engines)

1. Turn the ignition key to the ON position for about 30 seconds. The operator should hear the fuel pump operating.
2. Start the power unit. Repeat step 1 if necessary.

# SERVICE

## Priming the Fuel System (Diesel Engines)

1. Remove the rear frame tunnel cover.



2. Pull the primer bulb out of the frame far enough to squeeze it.
3. Squeeze the primer bulb, repeating until the fuel system is pressurized.
4. Start the engine. If the engine will not start, additional squeezing of the primer bulb may be required to ensure that fuel is delivered to the injector pump.
5. When the engine is running properly, turn off the engine.
6. Place the primer bulb back inside the tunnel area.
7. Reinstall the tunnel cover.

## CHECKING ALTERNATOR BELT (VANGUARD ENGINES)

### ⚠ CAUTION

AVOID PERSONAL INJURY!  
Fingers or loose clothing can get caught in rotating parts. Stop engine, remove key and wait for all moving parts to stop rotating before working on the power unit.

1. Park power unit on a level surface.
2. Engage parking brake and shut off engine.
3. Remove ignition key from switch.
4. Allow engine to cool.
5. Open engine hood.
6. Check belt for excessive wear, cracks, or damage.
7. Check for proper tension. Apply 20 lbs. of pres-

sure to the belt between the alternator and the water pump. The belt should deflect 3/8" to 1/2". Adjust if belt is too tight or too loose.

## ADJUSTING ALTERNATOR BELT TENSION (VANGUARD ENGINES)

### ⚠ CAUTION

AVOID PERSONAL INJURY!  
Fingers or loose clothing can get caught in rotating parts. Stop engine, remove key and wait for all moving parts to stop rotating before working on the power unit.

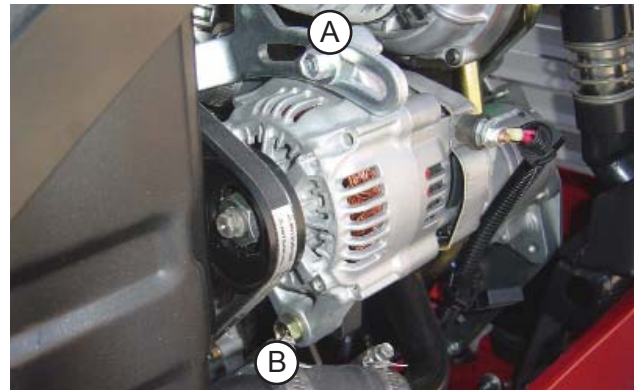

1. Loosen the adjustment bolt (A).
2. Loosen bottom alternator mounting bolt (B).
3. Adjust alternator in desired direction.
4. Tighten adjustment bolt (A).
5. Tighten alternator mounting bolt (B).
6. Recheck for proper tension. Apply 20 lbs. of pressure to the belt between the alternator and the water pump. The belt should deflect 3/8" to 1/2". Adjust if necessary.



# SERVICE

## SERVICING BATTERY



### CAUTION

#### AVOID PERSONAL INJURY!

**Battery electrolyte contains sulfuric acid. It is poisonous and can cause serious burns.**

- Wear eye protection and gloves.
- Keep skin protected.
- If electrolyte is swallowed, get medical attention immediately.
- If electrolyte is splashed in eyes, flush immediately with water for 15-30 minutes and seek medical attention.
- If electrolyte is splashed onto skin, flush immediately with water and get medical attention, if necessary.

**The battery produces a flammable and explosive gas. The battery may explode.**

- Do not smoke near battery.
- Wear eye protection and gloves.
- Do not allow direct metal contact across battery posts.
- Remove negative cable first when disconnecting.
- Install negative cable last when connecting.

## REMOVING AND INSTALLING BATTERY

### Removing:

1. Park power unit on a level surface.
2. Engage parking brake and shut off engine.
3. Remove ignition key from switch.
4. Tilt the seat plate forward and prop in place.
5. Disconnect the negative battery cable (A).
6. Disconnect the positive battery cable (B).

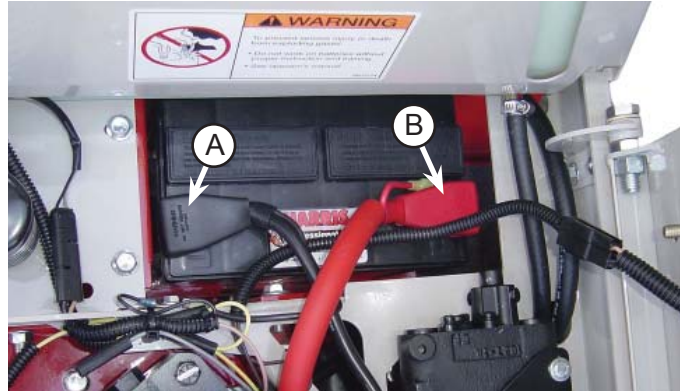

7. Loosen fastener (C) and remove battery clamp.



8. Slide battery out of battery compartment.

### Installing:

1. Slide battery into battery compartment.
2. Install battery clamp over battery flange and fasten. Do not over tighten.
3. Connect positive battery cable to the positive battery terminal first, then connect the negative battery cable to the negative battery terminal.
4. Apply dielectric grease to terminals to prevent corrosion.

## CLEANING BATTERY AND TERMINALS

1. Park power unit on a level surface.
2. Engage parking brake and shut off engine.
3. Remove ignition key from switch.
4. Disconnect and remove battery.
5. Wash battery with solution of four tablespoons of baking soda to one gallon of water. Be careful not to get the soda solution into the cell.

# SERVICE

6. Rinse the battery with plain water and dry.
7. Clean terminals and battery cable with wire brush until bright.
8. Apply dielectric grease to terminals to prevent corrosion.

## USING A BOOSTER BATTERY

### CAUTION

#### AVOID PERSONAL INJURY!

The battery produces a flammable and explosive gas. The battery may explode.

- Do not smoke near battery.
- Wear eye protection and gloves.
- Do not jump start or charge a cold or frozen battery. Warm battery first.
- Do not connect the negative booster cable to the negative terminal of the discharged battery. Connect at a good ground location on the engine away from the discharged battery.

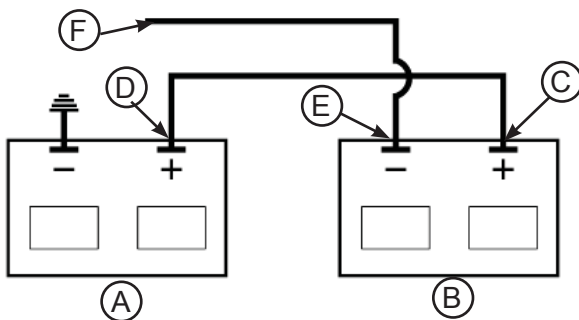

A - Disabled Power units Battery  
B - Booster Battery

Note: If using a vehicle to boost the battery, boosting vehicle must be shut off.

1. Connect positive booster cable to booster battery positive post (C).
2. Connect the other end of the positive booster cable to the disabled battery's positive post (D).
3. Connect negative booster cable to booster battery negative post (E).
4. Connect the other end (F) of the negative booster cable to a metal part of the disabled power unit's engine block away from battery.
5. Start the engine of the disabled power unit and run the power unit for several minutes.
6. Carefully disconnect the booster cables in the reverse order: negative cable first and then the positive cable.

## CHANGING THE HEADLIGHT BULB

### CAUTION

#### AVOID PERSONAL INJURY!

The headlight bulb contains gases under pressure. The bulb may shatter if the glass is scratched or dropped. Wear eye protection and handle bulb with care.

1. Park power unit on a level surface.
2. Engage parking brake and shut off engine.
3. Remove ignition key from switch.
4. Remove the two screws clamping the headlight cover on (A) and remove cover.

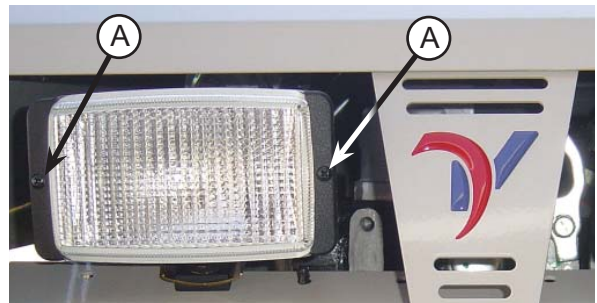

5. Disconnect ground wire from the defective headlight (B).
6. Remove wire loom and shrink wrap from positive wire (C) and disconnect the positive wire.
7. Remove the defective light bulb from the light assembly by pinching the wire spring fastener.
8. Install the new light bulb and secure with spring fastener (D).

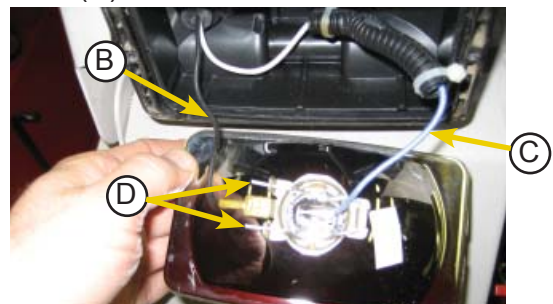

9. Place heat shrink tubing over the positive wire.
10. Reconnect the positive and negative wires as removed.
11. Slide the heat shrink tubing over the connector, apply heat to shrink, and replace the wire loom.
12. Reinstall the headlight cover.



# SERVICE

## CHANGING THE TAILLIGHTS

1. Park power unit on a level surface.
2. Engage parking brake and shut off engine.
3. Remove ignition key from switch.
4. Remove the taillight cover (A).



5. Pull the old bulb (B) from its socket.
6. Apply dielectric grease and install new bulb.
7. Snap taillight cover back into place.

## CHANGING THE FUSES

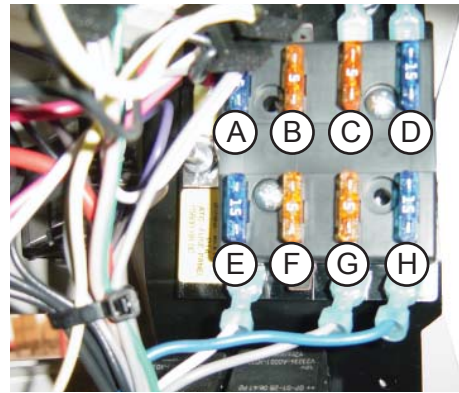

REF	CIRCUIT	FUSE SIZE
A	Headlights, Taillights, Tach. Light	15
B*	Alternator, Optional Accessories	5
C	Gauges, Signal Lights	5
D	Rear Auxiliary	15
E	Engine Supply	15
F*	Engine Module, Preheat, Optional Acc.	5
G*	Fuel Pump	5
H	Start and PTO Circuits	15

\* Not used on all models.

1. Park power unit on a level surface.
2. Engage parking brake and shut off engine.
3. Remove ignition key from switch.
4. Open engine hood.
5. Identify and pull the defective fuse from socket.
6. Push new fuse into socket. Be certain to use the correct size fuse, or damage may occur to the power unit.
7. Close engine hood.

# SERVICE

## SERVICING COOLING SYSTEM

### ⚠ CAUTION

#### AVOID PERSONAL INJURY!

If the unit has been running, the radiator and radiator coolant will be hot and can burn skin! Built-up pressure in the radiator can cause an explosive release of coolant if the radiator cap is removed:

- Shut off engine and allow to cool.
- Do not remove the cap unless the radiator and engine are cool enough to touch with bare hands.
- Slowly loosen cap to the first stop to release all the pressure before removing completely.

### ⚠ CAUTION

#### AVOID PERSONAL INJURY!

Wear personal protective equipment to protect eyes and hands when opening radiator cap to protect against the pressure in the radiator.

### ⚠ CAUTION

#### ENVIRONMENTAL HAZARD!

Antifreeze is hazardous to the environment. Dispose of antifreeze in a proper container and at a proper recycle center.

**⚠ ATTENTION: Avoid damage to your engine! Using incorrect coolant mixture and/or type can cause engine damage. See the Engine Owner's Manual for correct type.**

- Do not operate engine without coolant.
- Do not use plain water.
- Do not pour coolant into radiator when engine is hot.
- To prevent engine overheating, do not exceed more than 50% antifreeze in cooling system.

## CHECKING COOLING SYSTEM

1. Park power unit on a level surface.
2. Engage parking brake and shut off engine.
3. Remove ignition key from switch.
4. Allow engine to cool.
5. Open engine hood to access the radiator and the

radiator coolant recovery bottle.

6. Locate the coolant recovery bottle just in front of the air cleaner (Vanguard) or in front of the right side of the radiator (Kawasaki).
7. Check the level in the coolant recovery tank. When cold, level should be between the Low (A) and Full (B) marks on the tank.

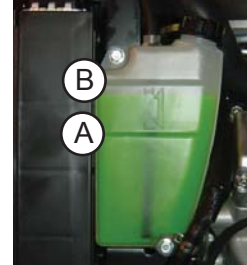
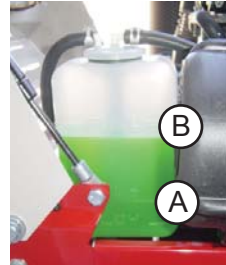

8. Add coolant if low.
9. If coolant recovery tank is empty, slowly open the radiator cap to the first stop to allow pressure to release. Press down on the cap slightly and continue to turn counterclockwise to remove cap from radiator. Check that the coolant level is up to the bottom of the filler neck.
10. If coolant is low, add coolant.
11. Install radiator cap.
12. Inspect condition of radiator hoses and clamps. Replace as necessary.
13. Close engine hood.

## CLEANING RADIATOR AND SCREEN

1. Park power unit on a level surface.
2. Engage parking brake and shut off engine.
3. Remove ignition key from switch.
4. Open engine hood to access radiator screen.
5. Remove radiator screen.



# SERVICE

6. Remove debris from screen with a brush, compressed air, or water.
7. When required, remove dirt and debris from radiator using compressed air or water. Spray from the fan side of radiator only.
8. Check radiator fins for damage.
9. Reinstall radiator screen.
10. Close engine hood.
9. Drain cooling system immediately before the rust and dirt settle.
10. Allow engine to cool.
11. Fill radiator with clean water and allow to flush out until the water comes out clear.
12. When water has drained from radiator, close the drain valve or reattach radiator hose to engine.
13. Fill the radiator with the proper coolant. See the Engine Owner's Manual for the correct type of coolant.
14. Install radiator cap.
15. Close engine hood.

## DRAINING COOLING SYSTEM

1. Park power unit on a level surface.
2. Engage parking brake and shut off engine.
3. Remove ignition key from switch.
4. Allow engine to cool.
5. Open engine hood.
6. Slowly open radiator cap to the first notch to allow pressure to release.
7. Drain radiator coolant into a pan by opening the drain valve (A) on the left side of the radiator (Vanguard) or removing the lower radiator hose (B) at the right side of the engine (Kawasaki).

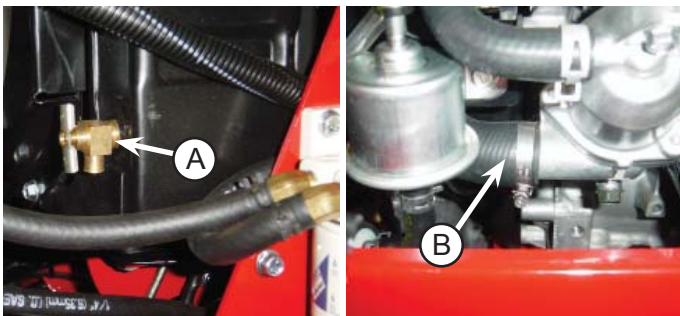

8. Flush the cooling system.

## FLUSHING THE COOLING SYSTEM

1. Park power unit on a level surface.
2. Engage parking brake and shut off engine.
3. Remove ignition key from switch.
4. Drain system. Add one can of radiator flush, (can be purchased at any auto parts store) and fill with clean water.
5. Install radiator cap.
6. Start engine and run until it reaches operating temperature. (160 - 180 degrees)
7. Shut off the engine.
8. Remove ignition key from switch.

# SERVICE

## INSPECTION OF PTO BELT

Periodically checking the PTO belt (A) of this power unit can prevent sudden failure by finding problems before they cause the belt to break. It is recommended to inspect the PTO belt every 50 hours of operation, or if a problem is suspected. There may be a PTO belt problem if there is a squealing or chattering sound, or the smell of a slipping belt.



1. Park power unit on a level surface.
2. Engage parking brake and shut off engine.
3. Remove ignition key from switch.

4. Check the PTO belt (A) at the PTO idler pulley (B).

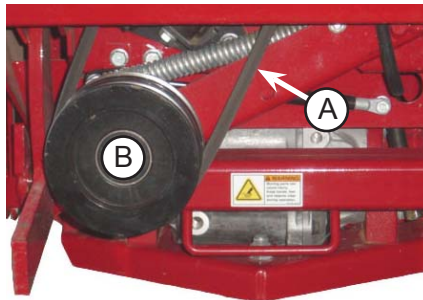

5. Typical wear on the PTO belt may result in the following conditions as shown at right. If any of these conditions occur, then the belt will require replacement.

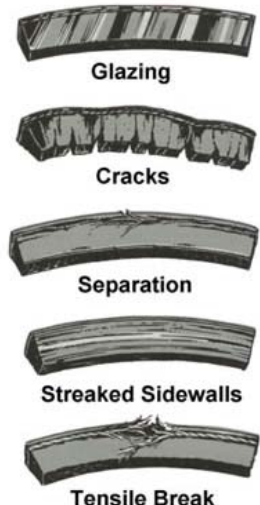

## PTO BELT REPLACEMENT

1. Park power unit on a level surface.
2. Engage parking brake and shut off engine.
3. Remove ignition key from switch and allow engine to cool.
4. Open engine hood.
5. Rotate the belt tension lever down to release tension on the PTO belt.
6. (**Vanguard only**) Remove the nut from the clutch rod (A) and remove rod from power unit frame.



7. (**Vanguard only**) Locate the clutch plug (B) and disconnect plug from power unit wire harness.
8. Lift up on the PTO idler pulley and remove the belt from the pulley.
9. Pull belt up between the power unit cross frame and the clutch to remove. If necessary, rotate clutch counterclockwise to increase gap between clutch and frame.
10. Push the new belt down between the frame and clutch.
11. Install the belt onto the clutch pulley.
12. Lift up on the PTO idler pulley and install the belt into the rear groove of the idler pulley.
13. (**Vanguard only**) Reconnect the clutch plug to the power unit wire harness.
14. (**Vanguard only**) Reinstall the clutch rod to the power unit frame.
15. Close engine hood.



# SERVICE

## PARKING BRAKE ADJUSTMENT

If the parking brake is not holding sufficiently, the brake linkage will need to be adjusted.

1. Park power unit on a level surface and block tires to prevent movement.
2. Move the selector lever out of the park brake position to relieve pressure on the brake linkage.
3. Tighten the 1/4" lock nut on the brake linkage rod several turns.



4. Check if sufficient pressure is applied for parking brake to hold.
5. Continue to adjust the 1/4" lock nut until brake hold is firm. If brake is adjusted to tight, it will be difficult to engage the selector lever in the park brake position.

## NEUTRAL ADJUSTMENT

The power unit should come to a complete stop when the selector lever is in the park brake (#1) or the spring assist to neutral (#2) position and the S.D.L.A. lever is in neutral. If the power unit consistently creeps while in neutral, the neutral position must be adjusted.

1. Park the power unit on a level surface.
2. Lift the power unit off the ground and secure with jack stands.

## ⚠ WARNING

Do not attempt to adjust the neutral position with the power unit wheels on the ground. During the adjustment process, the power unit could begin to move.

Lift the power unit off the ground and secure with jack stands to prevent the power unit from moving. This also allows neutral to be easily determined when any tire rotation stops.

3. Start the power unit and adjust engine speed to approximately 2,000 RPM.
4. Place selector lever in the spring assist to neutral position.
5. Locate the neutral adjustment bolt on the right base of the steering column.

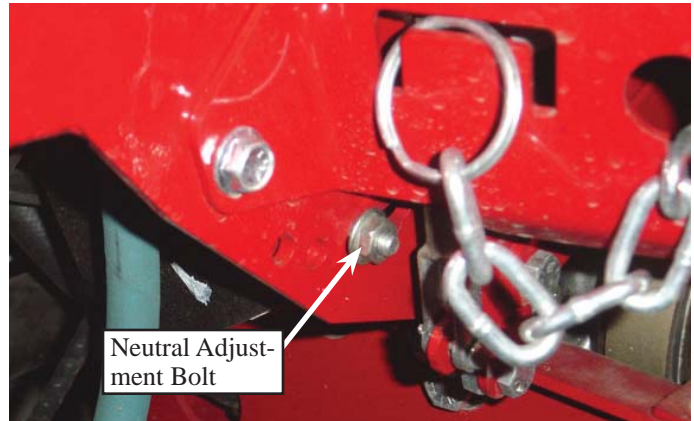

6. Loosen the nut just enough to free the grip of the bolt from the slot.
7. Move the bolt slightly in either direction until the tendency to creep stops. NOTE: a small screwdriver can aid in moving and holding the bolt in place until tightened.
8. Retighten the nut.

NOTE: If unsure of this procedure or your efforts fail to remedy the problem, contact your Ventrac dealer.

## RECOMMENDED TIRE PRESSURE

Tire	Single Wheel	Dual Wheels	
		Inner	Outer
All Terrain	8-16 psi (55-110 kPa)	8-10 psi (55-69 kPa)	6-8 psi (41-55 kPa)
Bar	8-16 psi (55-110 kPa)	8-10 psi (55-69 kPa)	6-8 psi (41-55 kPa)
Turf	15-20 psi (103-138 kPa)	15-17 psi (103-117 kPa)	10-12 psi (69-83 kPa)

# MAINTENANCE CHART

## MAINTENANCE SCHEDULE - VENTRAC 4200 POWER UNIT WITH KAWASAKI ENGINE

This sheet is a guide for recommended service and maintenance for the 4200 power unit and Kawasaki engine.

Maintenance Schedule	# of Locations	# of Pumps	AS NEEDED	After First 25 Hrs.	Daily	At 50 Hours	At 100 Hours	At 150 Hours	At 200 Hours	At 250 Hours	At 300 Hours	At 350 Hours	At 400 Hours	At 450 Hours	At 500 Hours	At 550 Hours	At 600 Hours	At 650 Hours	At 700 Hours	At 750 Hours	At 800 Hours	At 850 Hours	At 900 Hours	At 950 Hours	At 1000 Hours	Yearly	5 Years or 2000 Hrs.		
<b>Grease &amp; Lubrication: See Lubrication Section</b>																													
Front Hitch	2	1	✓		✓	✓	✓	✓	✓	✓	✓	✓	✓	✓	✓	✓	✓	✓	✓	✓	✓	✓	✓	✓	✓	✓	✓	✓	
Lift Cylinder	2	1	✓		✓	✓	✓	✓	✓	✓	✓	✓	✓	✓	✓	✓	✓	✓	✓	✓	✓	✓	✓	✓	✓	✓	✓	✓	
Center Pivot Ball Joint	1	1	✓		✓	✓	✓	✓	✓	✓	✓	✓	✓	✓	✓	✓	✓	✓	✓	✓	✓	✓	✓	✓	✓	✓	✓	✓	
Steering Cylinder End	2	1	✓		✓	✓	✓	✓	✓	✓	✓	✓	✓	✓	✓	✓	✓	✓	✓	✓	✓	✓	✓	✓	✓	✓	✓	✓	
Driveshaft U-joint	2	1	✓		✓	✓	✓	✓	✓	✓	✓	✓	✓	✓	✓	✓	✓	✓	✓	✓	✓	✓	✓	✓	✓	✓	✓	✓	
3 Pt Cylinder End <sup>@</sup>	2	1	✓		✓	✓	✓	✓	✓	✓	✓	✓	✓	✓	✓	✓	✓	✓	✓	✓	✓	✓	✓	✓	✓	✓	✓	✓	
3 Pt Pivot <sup>@</sup>	2	1	✓		✓	✓	✓	✓	✓	✓	✓	✓	✓	✓	✓	✓	✓	✓	✓	✓	✓	✓	✓	✓	✓	✓	✓	✓	
Lower Connector Link	2	&	✓		✓	✓	✓	✓	✓	✓	✓	✓	✓	✓	✓	✓	✓	✓	✓	✓	✓	✓	✓	✓	✓	✓	✓	✓	
Seat Rails	2	#	✓		✓	✓	✓	✓	✓	✓	✓	✓	✓	✓	✓	✓	✓	✓	✓	✓	✓	✓	✓	✓	✓	✓	✓	✓	
<b>Engine<sup>1</sup></b>																													
Check Engine Oil Level				✓																									
Change Engine Oil & Filter <sup>1</sup>			✓		✓	✓	✓	✓	✓	✓	✓	✓	✓	✓	✓	✓	✓	✓	✓	✓	✓	✓	✓	✓	✓	✓	✓	✓	
Clean/Replace Spark Plugs	Consult Engine Owner's Manual; Follow Service Intervals for Heavy Loads and High Temperatures*																												
Inspect Air Filter			✓																										
Clean Foam Air Filter Element	Consult Engine Owner's Manual; Follow Service Intervals for Heavy Loads and High Temperatures*																												
Replace Paper Air Filter Element	Consult Engine Owner's Manual; Follow Service Intervals for Heavy Loads and High Temperatures*																												
Check Coolant Level				✓																									
Service Cooling System																												✓	
Clean Engine Compartment, Engine, & Radiator	**		✓																										
Replace Fuel Filter	✓										✓									✓									
Drain Water & Sediment from Fuel Tank	✓																										✓		
<b>Hydraulic System</b>																													
Check Hydraulic Oil Level				✓																									
Check Rear Transaxle Oil Level								✓							✓														
Change Hydraulic Oil, Filters, and Rear Transaxle Oil																												✓	
<b>Parking Brake</b>																													
Inspect Parking Brake Tension				✓																									
<b>Electrical</b>																													
Replace Light Bulbs	✓																												
Clean Battery Terminals & Compartment	✓																											✓	
<b>Inspection</b>																													
Inspect for Loose, Missing, or Worn Components			✓																										
Inspect Belts, Fuel Lines, and Hydraulic Lines			✓																										
Check Tire Pressure			✓																										
Check Wheel Lug Nuts. Torque to 55 ft-lbs				✓	✓				✓				✓				✓					✓				✓			
Check Steering Cylinder Bolts. Torque to 170 ft-lbs					✓	✓	✓	✓	✓	✓	✓	✓	✓	✓	✓	✓	✓	✓	✓	✓	✓	✓	✓	✓	✓	✓	✓	✓	
Check Front/Rear Connector Link Bolts. Torque to 170 ft-lbs					✓	✓	✓	✓	✓	✓	✓	✓	✓	✓	✓	✓	✓	✓	✓	✓	✓	✓	✓	✓	✓	✓	✓	✓	
Check Front Hitch Pivot Bolts. Torque to 75 ft-lbs					✓	✓	✓	✓	✓	✓	✓	✓	✓	✓	✓	✓	✓	✓	✓	✓	✓	✓	✓	✓	✓	✓	✓	✓	
* If heavy load, high temperature, or dusty condition service intervals are not specified, Ventrac recommends servicing more frequently at 1/2 the standard service interval.																													
** Operation in severe conditions may require more frequent service intervals.																													
<sup>1</sup> Consult Engine Owner's Manual for engine oil information and complete servicing information.																													
<sup>@</sup> Optional Equipment.																													
<sup>^</sup> Grease Until Fresh Grease is visible.																													
<sup>&amp;</sup> Spray Lubricant.																													
<sup>#</sup> Silicon Based Spray Lubricant.																													

# MAINTENANCE CHART

## MAINTENANCE CHECKLIST - VENTRAC 4200 POWER UNIT WITH KAWASAKI ENGINE

This sheet is a checklist for tracking service and maintenance for the 4200 power unit and Kawasaki engine.

Maintenance Schedule	# of Locations	# of Pumps	AS NEEDED	After First 25 Hrs.	Daily	At 50 Hours	At 100 Hours	At 150 Hours	At 200 Hours	At 250 Hours	At 300 Hours	At 350 Hours	At 400 Hours	At 450 Hours	At 500 Hours	At 550 Hours	At 600 Hours	At 650 Hours	At 700 Hours	At 750 Hours	At 800 Hours	At 850 Hours	At 900 Hours	At 950 Hours	At 1000 Hours	Yearly	5 Years or 2000 Hrs.
<b>Grease &amp; Lubrication: See Lubrication Section</b>																											
Front Hitch	2	1																									
Lift Cylinder	2	1																									
Center Pivot Ball Joint	1	1																									
Steering Cylinder End	2	1																									
Driveshaft U-joint	2	1																									
3 Pt Cylinder End @	2	1																									
3 Pt Pivot @	2	1																									
Lower Connector Link	2	&																									
Seat Rails	2	#																									
<b>Engine<sup>1</sup></b>																											
Check Engine Oil Level																											
Change Engine Oil & Filter <sup>1</sup>																											
Clean/Replace Spark Plugs	Consult Engine Owner's Manual; Follow Service Intervals for Heavy Loads and High Temperatures*																										
Inspect Air Filter																											
Clean Foam Air Filter Element	Consult Engine Owner's Manual; Follow Service Intervals for Heavy Loads and High Temperatures*																										
Replace Paper Air Filter Element	Consult Engine Owner's Manual; Follow Service Intervals for Heavy Loads and High Temperatures*																										
Check Coolant Level																											
Service Cooling System																											
Clean Engine Compartment, Engine, & Radiator																											
Replace Fuel Filter																											
Drain Water & Sediment from Fuel Tank																											
<b>Hydraulic System</b>																											
Check Hydraulic Oil Level																											
Check Rear Transaxle Oil Level																											
Change Hydraulic Oil, Filters, and Rear Transaxle Oil																											
<b>Parking Brake</b>																											
Inspect Parking Brake Tension																											
<b>Electrical</b>																											
Replace Light Bulbs																											
Clean Battery Terminals & Compartment																											
<b>Inspection</b>																											
Inspect for Loose, Missing, or Worn Components																											
Inspect Belts, Fuel Lines, and Hydraulic Lines																											
Check Tire Pressure																											
Check Wheel Lug Nuts. Torque to 55 ft-lbs																											
Check Steering Cylinder Bolts. Torque to 170 ft-lbs																											
Check Front/Rear Connector Link Bolts. Torque to 170 ft-lbs																											
Check Front Hitch Pivot Bolts. Torque to 75 ft-lbs																											
* If heavy load, high temperature, or dusty condition service intervals are not specified, Ventrac recommends servicing more frequently at 1/2 the standard service interval.																											
** Operation in severe conditions may require more frequent service intervals.																											
1 Consult Engine Owner's Manual for engine oil information and complete servicing information																											
@ Optional Equipment																											
^ Grease Until Fresh Grease is visible																											
& Spray Lubricant																											
# Silicon Based Spray Lubricant																											

# MAINTENANCE CHART

## MAINTENANCE SCHEDULE - VENTRAC 4200 POWER UNIT WITH VANGUARD 3LC ENGINE

This sheet is a guide for recommended service and maintenance for the 4200 power unit and Vanguard 3LC engines.

Maintenance Schedule	# of Locations	# of Pumps	AS NEEDED	After First 25 Hrs.	Daily	At 50 Hours	At 100 Hours	At 150 Hours	At 200 Hours	At 250 Hours	At 300 Hours	At 350 Hours	At 400 Hours	At 450 Hours	At 500 Hours	At 550 Hours	At 600 Hours	At 650 Hours	At 700 Hours	At 750 Hours	At 800 Hours	At 850 Hours	At 900 Hours	At 950 Hours	At 1000 Hours	Yearly	5 Years or 2000 Hrs.	
<b>Grease &amp; Lubrication: See Lubrication Section</b>																												
Front Hitch	2	1	✓		✓	✓	✓	✓	✓	✓	✓	✓	✓	✓	✓	✓	✓	✓	✓	✓	✓	✓	✓	✓	✓	✓	✓	
Lift Cylinder	2	1	✓		✓	✓	✓	✓	✓	✓	✓	✓	✓	✓	✓	✓	✓	✓	✓	✓	✓	✓	✓	✓	✓	✓	✓	
Center Pivot Ball Joint	1	1	✓		✓	✓	✓	✓	✓	✓	✓	✓	✓	✓	✓	✓	✓	✓	✓	✓	✓	✓	✓	✓	✓	✓	✓	
Steering Cylinder End	2	1	✓		✓	✓	✓	✓	✓	✓	✓	✓	✓	✓	✓	✓	✓	✓	✓	✓	✓	✓	✓	✓	✓	✓	✓	
Driveshaft U-joint	2	1	✓		✓	✓	✓	✓	✓	✓	✓	✓	✓	✓	✓	✓	✓	✓	✓	✓	✓	✓	✓	✓	✓	✓	✓	
3 Pt Cylinder End <sup>®</sup>	2	1	✓		✓	✓	✓	✓	✓	✓	✓	✓	✓	✓	✓	✓	✓	✓	✓	✓	✓	✓	✓	✓	✓	✓	✓	
3 Pt Pivot <sup>®</sup>	2	1	✓		✓	✓	✓	✓	✓	✓	✓	✓	✓	✓	✓	✓	✓	✓	✓	✓	✓	✓	✓	✓	✓	✓	✓	
Lower Connector Link	2	&	✓		✓	✓	✓	✓	✓	✓	✓	✓	✓	✓	✓	✓	✓	✓	✓	✓	✓	✓	✓	✓	✓	✓	✓	
Seat Rails	2	#	✓		✓	✓	✓	✓	✓	✓	✓	✓	✓	✓	✓	✓	✓	✓	✓	✓	✓	✓	✓	✓	✓	✓	✓	
<b>Engine<sup>†</sup></b>																												
Check Engine Oil Level				✓																								
Change Engine Oil & Filter <sup>†</sup>			✓			✓		✓		✓		✓		✓		✓		✓		✓		✓		✓		✓		
Clean/Replace Spark Plugs (Gasoline Engines)	Consult Engine Owner's Manual; Follow Service Intervals for Heavy Loads and High Temperatures <sup>*</sup>																											
Inspect Primary Air Filter				✓																								
Replace Primary Air Filter	**				**	✓	**	✓	**	✓	**	✓	**	✓	**	✓	**	✓	**	✓	**	✓	**	✓	**	✓	**	
Replace Safety Air Filter										✓										✓								
Check Coolant Level				✓																								
Service Cooling System																											✓	
Clean Engine Compartment, Engine, & Radiator	**			✓																								
Replace Fuel Filter	✓										✓										✓							
Drain Water & Sediment from Fuel Tank	✓																										✓	
<b>Hydraulic System</b>																												
Check Hydraulic Oil Level				✓																								
Check Rear Transaxle Oil Level								✓						✓						✓					✓	✓		
Change Hydraulic Oil, Filters, and Rear Transaxle Oil																												✓
<b>Parking Brake</b>																												
Inspect Parking Brake Tension				✓																								
<b>Electrical</b>																												
Replace Light Bulbs	✓																											
Clean Battery Terminals & Compartment	✓																										✓	
<b>Inspection</b>																												
Inspect for Loose, Missing, or Worn Components				✓																								
Inspect Belts, Fuel Lines, and Hydraulic Lines				✓																								
Check Tire Pressure.				✓																								
Check Wheel Lug Nuts. Torque to 55 ft-lbs				✓	✓				✓					✓					✓						✓			
Check Steering Cylinder Bolts. Torque to 170 ft-lbs					✓	✓			✓	✓			✓	✓				✓	✓				✓	✓		✓		
Check Front/Rear Connector Link Bolts. Torque to 170 ft-lbs					✓	✓			✓	✓			✓	✓				✓	✓				✓	✓		✓		
Check Front Hitch Pivot Bolts. Torque to 75 ft-lbs					✓	✓			✓	✓			✓	✓				✓	✓				✓	✓		✓		

<sup>†</sup> If heavy load, high temperature, or dusty condition service intervals are not specified, Ventrac recommends servicing more frequently at 1/2 the standard service interval.

<sup>\*\*</sup> Operation in severe conditions may require more frequent service intervals.

<sup>†</sup> Consult Engine Owner's Manual for engine oil information and complete servicing information

<sup>®</sup> Optional Equipment

<sup>^</sup> Grease Until Fresh Grease is visible

<sup>&</sup> Spray Lubricant

<sup>#</sup> Silicon Based Spray Lubricant



# MAINTENANCE CHART

## MAINTENANCE CHECKLIST - VENTRAC 4200 POWER UNIT WITH VANGUARD 3LC ENGINE

This sheet is a checklist for tracking service and maintenance for the 4200 power unit and Vanguard 3LC engines.

Maintenance Schedule	# of Locations	# of Pumps	AS NEEDED	After First 25 Hrs.	Daily	At 50 Hours	At 100 Hours	At 150 Hours	At 200 Hours	At 250 Hours	At 300 Hours	At 350 Hours	At 400 Hours	At 450 Hours	At 500 Hours	At 550 Hours	At 600 Hours	At 650 Hours	At 700 Hours	At 750 Hours	At 800 Hours	At 850 Hours	At 900 Hours	At 950 Hours	At 1000 Hours	Yearly	5 Years or 2000 Hrs.
<b>Grease &amp; Lubrication: See Lubrication Section</b>																											
Front Hitch	2	1																									
Lift Cylinder	2	1																									
Center Pivot Ball Joint	1	1																									
Steering Cylinder End	2	1																									
Driveshaft U-joint	2	1																									
3 Pt Cylinder End <sup>®</sup>	2	1																									
3 Pt Pivot <sup>®</sup>	2	1																									
Lower Connector Link	2	&																									
Seat Rails	2	#																									
<b>Engine<sup>†</sup></b>																											
Check Engine Oil Level																											
Change Engine Oil & Filter <sup>†</sup>																											
Clean/Replace Spark Plugs (Gasoline Engines)	Consult Engine Owner's Manual; Follow Service Intervals for Heavy Loads and High Temperatures*																										
Inspect Primary Air Filter																											
Replace Primary Air Filter																											
Replace Safety Air Filter																											
Check Coolant Level																											
Service Cooling System																											
Clean Engine Compartment, Engine, & Radiator																											
Replace Fuel Filter																											
Drain Water & Sediment from Fuel Tank																											
<b>Hydraulic System</b>																											
Check Hydraulic Oil Level																											
Check Rear Transaxle Oil Level																											
Change Hydraulic Oil, Filters, and Rear Transaxle Oil																											
<b>Parking Brake</b>																											
Inspect Parking Brake Tension																											
<b>Electrical</b>																											
Replace Light Bulbs																											
Clean Battery Terminals & Compartment																											
<b>Inspection</b>																											
Inspect for Loose, Missing, or Worn Components																											
Inspect Belts, Fuel Lines, and Hydraulic Lines																											
Check Tire Pressure.																											
Check Wheel Lug Nuts. Torque to 55 ft-lbs																											
Check Steering Cylinder Bolts. Torque to 170 ft-lbs																											
Check Front/Rear Connector Link Bolts. Torque to 170 ft-lbs																											
Check Front Hitch Pivot Bolts. Torque to 75 ft-lbs																											
* If heavy load, high temperature, or dusty condition service intervals are not specified, Ventrac recommends servicing more frequently at 1/2 the standard service interval.																											
** Operation in severe conditions may require more frequent service intervals.																											
† Consult Engine Owner's Manual for engine oil information and complete servicing information																											
® Optional Equipment																											
^ Grease Until Fresh Grease is visible																											
& Spray Lubricant																											
# Silicon Based Spray Lubricant																											

# TROUBLESHOOTING

## ENGINE

SYMPTOM:	POSSIBLE CAUSE:
Starter will not engage.	Selector lever is not in the park position. PTO switch is engaged. Neutral start switch is out of adjustment. Dead battery. Blown fuse in start circuit. Faulty relay in start circuit. Electrical problem in start circuit.
Engine cranks, but won't start.	Faulty fuel pump. Insufficient fuel level. Fuel shut-off valve is turned off. Cold weather - let glow plugs cycle a second time. Glow plugs not working. Plugged fuel filters. Obstruction in the fuel line. Poor engine compression. Fuel shutoff solenoid not working. Faulty injector pump.
Engine runs rough.	Plugged or partially plugged fuel filters. Plugged or partially plugged air filters. Fuel cap vent is plugged or dirty (All diesel engines and Gasoline engines from Serial # 2929-4285). Stale fuel, dirty fuel, insufficient fuel level. Faulty fuel pump. Dirty or faulty fuel injectors. Faulty injector pump.
Engine is low in power.	Plugged or partially plugged fuel filters (most common). Plugged or partially plugged air filters. Low cylinder compression. Dirty or faulty fuel injectors/pump.
Engine overheats.	Dirty radiator screen. Low coolant level. Debris in engine compartment. Defective radiator cap. Defective thermostat. Loose alternator/fan belt.
Oil light comes on when running.	Low in oil. Faulty oil sender. Faulty oil pump.

# TROUBLESHOOTING

## ENGINE CONT.

SYMPTOM:	POSSIBLE CAUSE:
Engine emits white exhaust smoke.	Low engine temperature; Allow engine to warm up. Leaking head gasket. Water in combustion chamber.
Engine emits black or gray exhaust smoke.	Plugged air intake system. Engine burning oil. Dirty or faulty injectors.
Excessive fuel consumption.	Plugged air intake system. Dirty or faulty injectors. Carburetor not functioning properly.
Engine uses excessive oil.	Check for leaks. Incorrect engine oil. Plugged air intake filter. Worn rings or cylinder walls.

## ELECTRICAL

SYMPTOM:	POSSIBLE CAUSE:
Battery does not charge.	Loose or corroded connections. Broken or loose wire in charge system. Defective battery. Loose alternator belt. Defective alternator. Defective voltage regulator.
Lights do not activate.	Blown fuse. Blown light bulb. Broken wire/connection. Faulty light switch.
Glow plugs do not activate.	Blown fuse. Faulty relay. Faulty glow plugs. Electrical problem.
PTO does not engage.	Faulty seat switch. NOTE: Operator must be in seat. Faulty PTO switch. Faulty PTO relay switch. PTO belt failure. Clutch out of adjustment. Faulty clutch. Electrical problem.

# TROUBLESHOOTING

---

## HYDRAULIC

SYMPTOM:	POSSIBLE CAUSE:
Front attachment fails to lift.	Low hydraulic oil. Excessive load on hitch. Faulty hydraulic cylinder. Low hydraulic charge pressure. Bolt missing from hitch frame or lift cylinder.
Steering is difficult.	Low hydraulic oil. Faulty hydraulic cylinder. Cold temperature. Allow power unit to warm up.
Excessive noise in hydraulic system.	Low hydraulic oil. Cold temperature. Allow power unit to warm up.

## POWER UNIT

SYMPTOM:	POSSIBLE CAUSE:
Power unit will not move with engine running.	Selector lever is in the park position. Brake does not release. Low hydraulic oil. Pump control linkage is loose. High/low range shift lever is in neutral. Suspension seat lock is engaged. (If equipped)



# SPECIFICATIONS

ENGINE	4226D	4227	4231	4231TD
Manufacturer	Vanguard	Kawasaki	Vanguard	Vanguard
Model Number	950D	FD750D	950G	950DT
Type	Diesel	Gasoline	Gasoline	Turbo Diesel
Cylinders	3	2	3	3
Displacement	953 cc	715 cc	953 cc	953 cc
Engine Gross HP	26.5	27	31	31
Operating Range (RPM)	1500-3650	1550-3600	1500-3650	1500-3650
Cooling System	Liquid Cooled	Liquid Cooled	Liquid Cooled	Liquid Cooled

## ELECTRICAL

Battery . . . . .	450 Cold Cranking Amps
Voltage . . . . .	12 Volts
Alternator . . . . .	20 Amp (Kawasaki), 40 Amp (Vanguard)

## POWER TRAIN

Type . . . . .	Hydrostatic (All Wheel Drive)
Hydrostatic Transaxle (2) . . . . .	Peerless
Fwd Speed (High)* . . . . .	10 mph (16.1 kph)
Fwd Speed (Low)* . . . . .	5.2 mph (8.4 kph)
Brakes . . . . .	Hydro-Dynamic
Hydraulic Oil Filtration . . . . .	10 Micron & 25 Micron

## CONTROLS & INSTRUMENT PANEL

Steering . . . . .	Power
PTO (Power Take Off) . . . . .	Electric w/brake
Throttle Control . . . . .	Cable
Directional Control . . . . .	Speed, Direction, Lift, Auxiliary (S.D.L.A)
Control Orientation . . . . .	Hand
Gauges . . . . .	Tachometer, Volt, Water Temperature
Parking/Emergency Brake . . . . .	Band Brake

## OTHER FEATURES

Turning Radius . . . . .	43" (109 cm)
Standard Tires . . . . .	All Terrain (22 x 12-8) (56 x 30-20 cm)
Optional Tires . . . . .	Turf (22 x 11-10) (56 x 28-26 cm)
Optional Tires . . . . .	Bar (21 x 11-8) (53 x 28-20 cm)
Headlight . . . . .	Halogen (55 watt)
Attachment System . . . . .	Ventrac Mount

\* May vary based on tire size, type, and inflation.

# SPECIFICATIONS

## DIMENSIONS

Wheelbase . . . . .	. 43" (109 cm)
Overall Length. . . . .	. 79" (201 cm)
Overall Height (top of ROPS bar) . . . . .	. 67" (170 cm)
Overall Width (single tires)*. . . . .	. 48" (122 cm)
Overall Width (dual tires)* . . . . .	. 70" (178 cm)
Weight** . . . . .	1,493-1,630 lbs. (677-739 kg)

Venture Products, Inc. reserves the right to change these specifications without notice.

\* May vary based on tire size, type, and inflation.

\*\* Weight varies based on engine size, tire options, and optional accessories.

## FLUID CAPACITIES

Ventrac 4200 Fluid Capacities			
Engine Oil*	4227 Gas	2.1 qt	2.0L
	4231 Gas	3.5 qt	3.3L
	4226 Diesel	3.5 qt	3.3L
	4231 Turbo Diesel	3.5 qt	3.3L
Hydraulic Oil	Hydraulic System, Standard Power Unit*	11.4 qt	10.6L
	Equipped w/ 3pt Hitch*	11.8 qt	11.2L
	Rear Transaxle	4 qt	3.8L
Coolant (Antifreeze)	4227 Gas	2.9 qt	2.7L
	4231 Gas	4 qt	3.8L
	4226 Diesel	4 qt	3.8L
	4231 Turbo Diesel	5 qt	4.7L
Fuel (Diesel or Unleaded Gasoline)	Plastic Fuel Tank	7.25 Gallons	27.4L
Fuel (Unleaded Gasoline)	Steel Fuel Tank	6 Gallons	22.7L
*When Changing both oil and filter.			

# WARRANTY



## LIMITED WARRANTY - VENTRAC TURF EQUIPMENT

Venture Products, Inc. (shall be referred to as V.P.I.) warrants on the terms and conditions herein, that it will repair, replace, or adjust any part manufactured by Venture Products Inc. and found by Venture Products Inc. to be defective in material and / or workmanship.

Effective September 1<sup>st</sup> 2005, Ventrac warranty on power units & attachments (excluding the HG100/HG150 generator) for **residential use only** is limited to **three (3) years** from original purchase date. Ventrac power units & attachments used **commercially or for any income-producing purpose** is limited to **two (2) years** from original purchase date. Ventrac ET200 turbine blower (turbine only) is limited to **two (2) years** from original purchase date. Ventrac HG100/HG150 generator is limited to **one (1) year** from original purchase date. Ventrac power units & attachments used for **rental** is limited to **180 days** from original purchase date. (NOTE: All accessories such as: 3-point hitch, foot pedal, dual wheel kit, etc. will be covered under the above warranty periods as they would apply provided they are installed by an authorized Ventrac dealer.) This warranty may be transferred and will carry the remainder of the warranty starting from the original purchase/registration date with the dealership and/or V.P.I. In the event that product/s originally registered as **(3) year residential use** are to be transferred to a commercial user, the warranty would change to the remainder of **(2) year commercial use** starting from the original purchase/registration date with the dealership and/or V.P.I.

If this warranty covers a consumer product as defined by the Magnusson-Moss warranty act, no warranties, express or implied, (including, but not limited to, the warranty of merchantability or fitness for a particular purpose) shall extend beyond the applicable time period stated in bold face type above.

If this warranty covers a product used commercially or for any income producing purpose, the foregoing warranties are in lieu of all other warranties and no representations, guarantees or warranties, express or implied, (including, but not limited to, a warranty of merchantability or fitness for a particular purpose), are made by V.P.I. in connection with the manufacture or sale of its products.

The engine warranty is covered by its respective engine manufacturer. Please refer to the engine manufacturer's warranty statement that is included in the owner's manual.

The Ventrac turf equipment, including any defective parts, must be returned to an authorized Ventrac dealer within the warranty period. The warranty shall extend to the cost to repair or replace (as determined by V.P.I.) the defective part. **The expense of pickup and delivery of equipment, service call drive time or any transportation expense incurred for warranty repair is the sole responsibility of the owner and is not covered under warranty by Ventrac and/or V.P.I.** V.P.I.'s responsibility in respect to claims is limited to making the required repairs or replacements, and no claim of breach of warranty shall be cause for cancellation or rescission of the contract of sale of any Ventrac equipment. Proof of purchase may be required by the dealer to substantiate any warranty claim. Only warranty work performed and submitted by an authorized Ventrac dealer may be eligible for warranty credit.

This warranty extends only to Ventrac turf equipment operated under normal conditions and properly serviced and maintained. The warranty expressly does **not** cover: (a) any defects, damage or deterioration due to normal use, wear and tear, or exposure; (b) normal maintenance services, such as cleaning, lubrication, oil change; (c) replacement of service items, such as oil, lubricants, spark plugs, belts, rubber hoses or other items subject to normal service replacement; (d) damage or defects arising out of, or relating to abuse, misuse, neglect, alteration, negligence or accident; (e) repair or replacement arising from operation of, or use of the turf equipment which is not in accordance with operating instructions as specified in the operator's manual or other operational instructions provided by V.P.I.; (f) repair or replacement arising as a result of any operation from Ventrac turf equipment that has been altered or modified so as to, in the determination of V.P.I., adversely affect the operation, performance or durability of the equipment or that has altered, modified or affected the turf equipment so as to change the intended use of the product; (g) repair or replacement necessitated by the use of parts, accessories or supplies, including gasoline, oil or lubricants, incompatible with the turf

# WARRANTY

---



## LIMITED WARRANTY - VENTRAC TURF EQUIPMENT

equipment or other than as recommended in the operator's manual or other operational instructions provided by V.P.I.; (h) repairs or replacements resulting from parts or accessories which have adversely affected the operation, performance or durability of the turf equipment; or (i) damage or defects due to or arising out of repair of Ventrac turf equipment by person or persons other than an authorized Ventrac service dealer or the installation of parts other than genuine Ventrac parts or Ventrac recommended parts.

The sole liability of V.P.I. with respect to this warranty shall be repair and replacement as set forth herein. V.P.I. shall have no liability for any other cost, loss, or damage. In particular V.P.I. shall have no liability or responsibility for: (i) expenses relating to gasoline, oil, lubricants; (ii) loss, cost, or expense relating to transportation or delivery of turf equipment from the location of owner or location where used by owner to or from any authorized Ventrac dealer; (iii) travel time, overtime, after hours time or other extraordinary repair charges or charge relating to repairs or replacements outside of normal business hours at the place of business of an authorized Ventrac dealer; (iv) rental of like or similar replacement equipment during the period of any warranty repair or replacement work; (v) any telephone or telegram charges; (vi) loss or damage to person or property other than that covered by the terms of this warranty; (vii) any claims for lost revenue, lost profit or additional cost or expense incurred as a result of a claim of breach of warranty; or (viii) attorney's fees.

The remedies of buyer set forth herein are exclusive and are in lieu of all other remedies. The liability of V.P.I., whether in contract, tort, under any warranty, or otherwise, shall not extend beyond its obligation as set forth herein. V.P.I. shall not be liable for cost of removal or installation nor shall V.P.I. be responsible for any direct, indirect, special or consequential damages of any nature. In no event shall V.P.I. be liable for any sum in excess of the price received for the goods for which liability is claimed.

There are no representations or warranties which have been authorized to the buyer of the turf equipment other than set forth in this warranty. Any and all statements or representations made by any seller of this equipment, including those set forth in any sales literature or made orally by any sales representative, are superseded by the terms of this warranty. Any affirmation of fact or promise made by V.P.I. or any of its representatives to the buyer which relates to the goods that are the subject to this warranty shall not be regarded as part of the basis of the bargain and shall not be deemed to create any express warranty that such goods shall conform to the affirmation or promise.

No employee, distributor, or representative is authorized to change the foregoing warranties in any way or grant any other warranty on behalf of V.P.I.

Some states do not allow limitations on how long an implied warranty lasts or allow the exclusion on limitation of incidental or consequential damages, so the above limitation or exclusion may not apply to you.

This warranty gives you specific legal rights, and you may also have other rights which vary from state to state.

This warranty applies to all Ventrac turf equipment sold in the United States and Canada.