



Operator's Manual

KC220

Stump Grinder





500 Venture Drive
Orrville, OH 44667
www.ventrac.com

To the Owner Contact Information and Product Identification

If you need to contact an authorized Ventrac dealer for information on servicing your product, always provide the product model and serial numbers.

Please fill in the following information for future reference. See the picture(s) below to find the location of the identification numbers. Record them in the spaces provided.

Dealer _____ Date of Purchase: _____

Dealer Address: _____

Dealer Phone Number: _____ Dealer Fax Number: _____

With your mobile device, you can scan the QR code on the serial number plate to access manuals, warranty, and other product information.

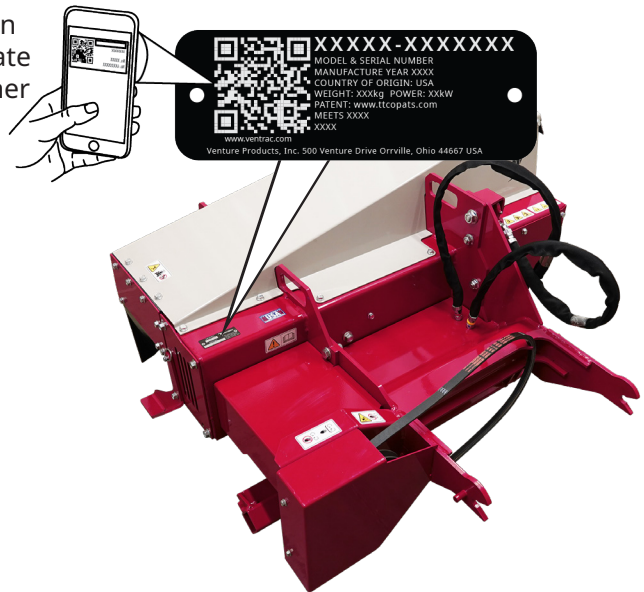

Model # _____

Serial # _____

Venture Products Inc. reserves the right to make changes in design or specifications without obligation to make like changes on previously manufactured products.

TABLE OF CONTENTS

INTRODUCTION	PAGE 4
Product Description	4
Why Do I Need an Operator’s Manual?	4
Using Your Manual	5
Manual Glossary	5
SAFETY	PAGE 6
General Safety Procedures	6
Training Required	6
Requirements for Personal Protective Equipment (PPE)	6
Operation Safety.	6
Keep Riders Off	8
Operating On Slopes	8
Truck Or Trailer Transport	9
Maintenance	9
Fuel Safety	10
Hydraulic Safety	11
KC220 Additional Requirements for Personal Protective Equipment (PPE).	12
Safety Decals	13
OPERATIONAL CONTROLS	PAGE 15
Primary SDLA Control Lever	15
Secondary SDLA Control Lever	15
GENERAL OPERATION	PAGE 16
Daily Inspection	16
Attaching	16
Detaching.	16
Operating Procedure	17
Transport of the Attachment.	17
SERVICE	PAGE 18
Cleaning and General Maintenance.	18
Belt Inspection.	18
Attachment Belt Replacement	18
Rotor Drive Belt Replacement	18
Cutting Teeth Rotation or Replacement	19
Lubrication Locations	20
Storage	20
Maintenance Schedule	21
Maintenance Checklist	21
SPECIFICATIONS	PAGE 22
Dimensions.	22
Features.	22

INTRODUCTION



Venture Products Inc. is pleased to provide you with your new Ventrac stump grinder! We hope that Ventrac equipment will provide you with a ONE Tractor Solution.

Product Description

The Ventrac KC220 stump grinder is designed to grind and remove tree stumps and surface roots. The heavy duty, carbide teeth provide extended and effective performance in spite of dirt, stones, and debris in the work area.

Why Do I Need an Operator's Manual?

This manual has been created to help you gain the important knowledge of what is needed to safely operate and maintain your machine, and to avoid injury and product damage. It is divided into chapters for convenient reference of the appropriate information.

You must read and understand the operator's manual for each piece of Ventrac equipment you own. Reading the operator's manual will help you become familiar with each specific piece of equipment. If this manual becomes damaged or unreadable, it should be replaced immediately. Contact your local Ventrac dealer for a replacement.

When using a Ventrac attachment, be sure to read and follow the safety and operating instructions of both the power unit and the attachment being used to ensure the safest operation possible.

The information in this manual provides the operator with the safest procedures to operate the machine while getting the maximum use out of the unit. Failure to follow the safety precautions listed in this manual may result in personal injury and/or damage to the equipment.

INTRODUCTION

Using Your Manual

This manual identifies potential hazards and safety concerns to help you, as well as others, avoid personal injury and/or damage to the equipment.

Safety should always be the first priority when working on or operating equipment. Accidents are more likely to occur when proper operating procedures are not followed or inexperienced operators are involved.

SYMBOL DEFINITIONS



This symbol identifies potential health and safety hazards. It marks safety precautions. Your safety and the safety of others is involved.

There are three signal words that describe the level of safety concern: Danger, Warning, and Caution.

SIGNAL WORD DEFINITIONS

DANGER

Indicates an imminently hazardous situation which, if not avoided, will result in death or serious injury. This signal word is limited to the most extreme cases.

WARNING

Indicates a potentially hazardous situation which, if not avoided, could result in death or serious injury.

CAUTION

Indicates a potentially hazardous situation which, if not avoided, may result in minor or moderate injury and/or property damage. It may also be used to alert against unsafe practices.

This manual also uses two words to highlight information. **ATTENTION** calls attention to special mechanical information to prevent equipment damage and/or best practices for equipment service and care.

NOTE emphasizes general information that is worthy of special attention.

Note: Right-Hand and Left-Hand orientations may be referred to at different places throughout this manual. Right-Hand and Left-Hand is determined as if facing forward from the operator station.

Manual Glossary

- Power Unit** A Ventrac tractor or other Ventrac engine powered device that may be operated by itself or with an attachment or accessory.
- Attachment** A piece of Ventrac equipment that requires a Power Unit for operation.
- Accessory** A device that attaches to a Power Unit or Attachment to extend its capabilities.
- Machine** Describes any "Attachment" or "Accessory" that is used in conjunction with a power unit.

SAFETY



General Safety Procedures for Ventrac Power Units, Attachments, & Accessories



Training Required

- The owner of this machine is solely responsible for properly training the operators.
- The owner/operator is solely responsible for the operation of this machine and for the prevention of accidents or injuries occurring to him/herself, other people, or property.
- Do not allow operation or service by children or untrained personnel. Local regulations may restrict the age of the operator.
- Before operating this machine, read the operator's manual and understand its contents.
- If the operator of the machine cannot understand this manual, then it is the responsibility of this machine's owner to fully explain the material within this manual to the operator.
- Learn and understand the use of all the controls.
- Know how to stop the power unit and the attachments quickly in the event of an emergency.

Requirements for Personal Protective Equipment (PPE)

- The owner is responsible for ensuring that all the operators use the proper PPE while operating the machine. Whenever you use the machine, use the following PPE:
- Certified eye protection and hearing protection.
- Closed toe, slip resistant footwear.
- Long pants or trousers.
- A dust mask for dusty conditions.
- Additional PPE may be required. Refer to the product safety procedures for any additional requirements.

Operation Safety

- Secure long hair and loose clothing. Do not wear jewelry.
- Inspect the machine before operation. Repair or replace any damaged, worn, or missing parts. Be sure the guards and shields are in proper working condition and are secured in place. Make any necessary adjustments before operating the machine.
- Some pictures in this manual may show shields or covers opened or removed in order to clearly illustrate the instructions. Under no circumstance should the machine be operated without these devices in place.
- Alterations or modifications to this machine can reduce safety and could cause damage to the machine. Do not alter the safety devices or operate with the shields or covers removed.
- Before each use, verify that all the controls function properly and inspect all the safety devices. Do not operate if the controls or safety devices are not in proper working condition.
- Check the parking brake function before operating. Repair or adjust the parking brake if necessary.
- Observe and follow all of the safety decals.
- All the controls are to be operated from the operator's station only.

SAFETY



General Safety Procedures for Ventrac Power Units, Attachments, & Accessories



- Always wear a seat belt if the machine has a roll cage/bar installed and in the upright position.
- Ensure the attachment or accessory is locked or fastened securely to the power unit before operating.
- Ensure that all bystanders are clear of the power unit and the attachment before operating. Stop the machine if someone enters your work area.
- Always be alert to what is happening around you, but do not lose focus on the task you are performing. Always look in the direction the machine is moving.
- Look behind and down before backing up to be sure of a clear path.
- If you hit an object, stop and inspect the machine. Make any necessary repairs before operating the machine again.
- Stop operation immediately at any sign of equipment failure. An unusual noise can be a warning of equipment failure or a sign that maintenance is required. Make any necessary repairs before operating the machine again.
- If equipped with a high/low range feature, never shift between high and low range while on a slope. Always move the machine to level ground and engage the parking brake before shifting range.
- Do not leave the machine unattended while it is running.
- Always park the machine on level ground.
- Always shut off the engine when connecting the attachment drive belt to the power unit.
- Never leave the operator's station without lowering the attachment to the ground, engaging the parking brake, shutting off the engine, and removing the ignition key. Make sure all moving parts have come to a complete stop before dismounting.
- Never leave the machine unattended without lowering the attachment to the ground, engaging the parking brake, shutting off the engine, and removing the ignition key.
- Only operate in well-lit conditions.
- Do not operate when there is a risk of lightning.
- Never direct the discharge of any attachment in the direction of people, buildings, animals, vehicles, or other objects of value.
- Never discharge material against a wall or obstruction. The material may ricochet back toward the operator.
- Use extra caution when approaching blind corners, shrubs, trees, or other objects that may obscure your vision.
- Do not run the engine in a building without adequate ventilation.
- Do not touch the engine or the muffler while the engine is running or immediately after stopping the engine. These areas may be hot enough to cause a burn.
- Do not change the engine governor settings or over-speed the engine. Operating the engine at excessive speeds may increase the hazard of personal injury.
- To reduce the hazard of fire, keep the battery compartment, engine, and muffler areas free of grass, leaves, excessive grease, and other flammable materials.

SAFETY



General Safety Procedures for Ventrac Power Units, Attachments, & Accessories



- Clear the working area of objects that might be hit or thrown from the machine.
- Keep people and pets out of the working area.
- Know the work area well before operation. Do not operate where traction or stability is questionable.
- Reduce speed when you are operating over rough ground.
- Equipment can cause serious injury and/or death when improperly used. Before operating, know and understand the operation and safety of the power unit and the attachment being used.
- Do not operate the machine if you are not in good physical and mental health, if you will be distracted by personal devices, or if you are under the influence of any substance which might impair your decisions, dexterity, or judgment.
- Children are attracted to machine activity. Be aware of children and do not allow them in the work area. Turn off the machine if a child enters the work area.
- Power units, attachments, and accessories are not designed or intended for travel on public roadways. Never operate or travel on public roads or highways.
- Operate with safety lights when operating near roadways.
- Slow down and be careful of traffic when operating near or crossing roadways. Stop before crossing roads or sidewalks. Use care when approaching areas or objects that may obscure vision.

Keep Riders Off

- Only allow the operator on the power unit. Keep riders off.
- Never allow riders on any attachment or accessory.

Operating On Slopes

- Slopes can cause loss-of-control and tip-over accidents, which can result in severe injury or death. Be familiar with the emergency parking brake, along with the power unit controls and their functions.
- If the power unit is equipped with a fold down roll bar, it must be locked in the upright position when operating on any slope.
- Use low range (if equipped) when operating on slopes greater than 15 degrees.
- Do not stop or start suddenly when operating on slopes.
- Never shift between high and low range while on a slope. Always move the power unit to level ground and engage the parking brake before shifting range or placing the power unit in neutral.
- Variables such as wet surfaces and loose ground will reduce the degree of safety. Do not drive where the machine could lose traction or tip over.
- Keep alert for hidden hazards in the terrain.
- Stay away from drop-offs, ditches, and embankments.
- Sharp turns should be avoided when operating on slopes.

SAFETY



General Safety Procedures for Ventrac Power Units, Attachments, & Accessories



- Pulling loads on hills decreases safety. It is the responsibility of the owner/operator to determine loads that can safely be controlled on slopes.
- Transport the machine with the attachment lowered or close to the ground to improve stability.
- While operating on slopes, drive in an up and down direction whenever possible. If turning is necessary while driving across slopes, reduce your speed and turn slowly in the downhill direction.
- Ensure a sufficient supply of fuel for continuous operation. A minimum of one-half tank of fuel is recommended.

Truck Or Trailer Transport

- Use care when loading or unloading the machine into a truck or trailer.
- Use full width ramps for loading the machine into a truck or trailer.
- The parking brake is not sufficient to lock the machine during transport. Always secure the power unit and/or attachment to the transporting vehicle securely using straps, chains, cables, or ropes. Both the front and rear straps should be directed down and outward from the machine.
- Shut off the fuel supply to the power unit during transport on a truck or trailer.
- If equipped, turn the battery disconnect switch to the Off position to shut off electrical power.

Maintenance

- Keep the safety decals legible. Remove all grease, dirt, and debris from the safety decals and instructional labels.
- If any decals are faded, illegible, or missing, contact your dealer promptly for replacements.
- When new components are installed, be sure that the current safety decals are affixed to the replacement components.
- If any component requires replacement, use only original Ventrac replacement parts.
- Always turn the battery disconnect to the Off position or disconnect the battery before performing any repairs. Disconnect the negative terminal first and the positive terminal last. Reconnect the positive terminal first and the negative terminal last.
- Keep all bolts, nuts, screws, and other fasteners properly tightened.
- Always lower the attachment to the ground, engage the parking brake, shut off the engine, and remove the ignition key. Make sure all moving parts have come to a complete stop before cleaning, inspecting, adjusting, or repairing.
- If the power unit, attachment, or accessory requires repairs or adjustments not instructed in the operator's manual, the power unit, attachment, or accessory must be taken to an authorized Ventrac dealer for service.
- Never perform maintenance on the power unit and/or attachment if someone is in the operator's station.
- Always use protective glasses when handling the battery.
- Check the fuel lines for tightness and wear on a regular basis. Tighten or repair them as needed.
- To reduce the hazard of fire, keep the battery compartment, engine, and muffler areas free of grass, leaves, and excess grease.

SAFETY



General Safety Procedures for Ventrac Power Units, Attachments, & Accessories



- Do not touch the engine, the muffler, or other exhaust components while the engine is running or immediately after stopping the engine. These areas may be hot enough to cause a burn.
- Allow the engine to cool before storing and do not store near an open flame.
- Do not change the engine governor settings or over-speed the engine. Operating engine at excessive speeds may increase the hazard of personal injury.
- Springs may contain stored energy. Use caution when disengaging or removing springs and/or spring loaded components.
- An obstruction or blockage in a drive system or moving/rotating parts may cause a buildup of stored energy. When the obstruction or blockage is removed, the drive system or moving/rotating parts may move suddenly. Do not attempt to remove an obstruction or blockage with your hands. Keep your hands, feet, and clothing away from all power-driven parts.

Fuel Safety

- To avoid personal injury or property damage, use extreme care in handling gasoline. Gasoline is extremely flammable and the vapors are explosive.
- Do not refuel the machine while smoking or at a location near flames or sparks.
- Always refuel the machine outdoors.
- Do not store the machine or fuel container indoors where the fumes or fuel can reach an open flame, spark, or pilot light.
- Only store fuel in an approved container. Keep out of the reach of children.
- Never fill containers inside a vehicle or on a truck or trailer bed with a plastic liner. Always place the containers on the ground away from your vehicle before filling.
- Remove the machine from the truck or trailer and refuel it on the ground. If this is not possible, refuel the machine using a portable container, rather than from a fuel dispenser nozzle.
- Never remove the fuel cap or add fuel with the engine running. Allow the engine to cool before refueling.
- Never remove the fuel cap while on a slope. Only remove the fuel cap when parked on a level surface.
- Replace the fuel tank cap and the container cap securely.
- Do not overfill the fuel tank. Only fill to the bottom of the fuel neck, do not fill the fuel neck full. Overfilling of the fuel tank could result in engine flooding, fuel leakage from the tank, and/or damage to the emissions control system.
- If fuel is spilled, do not attempt to start the engine. Move the power unit away from the fuel spill and avoid creating any source of ignition until the fuel vapors have dissipated.
- If the fuel tank must be drained, it should be drained outdoors into an approved container.
- Check the fuel lines for tightness and wear on a regular basis. Tighten or repair them as needed.
- The fuel system is equipped with a shut-off valve. Shut off the fuel when transporting the machine to and from the job, when parking the machine indoors, or when servicing the fuel system.

SAFETY



General Safety Procedures for Ventrac Power Units, Attachments, & Accessories



Hydraulic Safety

- Make sure the hydraulic connections are tight and all hydraulic hoses and tubes are in good condition. Repair any leaks and replace any damaged or deteriorated hoses or tubes before starting the machine.
- Hydraulic leaks can occur under high pressure. Hydraulic leaks require special care and attention.
- Use a piece of cardboard and a magnifying glass to locate suspected hydraulic leaks.
- Keep your body and hands away from pinhole leaks or nozzles that eject high pressure hydraulic fluid. Hydraulic fluid escaping under high pressure can penetrate the skin causing serious injury, leading to severe complications and/or secondary infections if left untreated. If hydraulic fluid is injected into the skin, seek immediate medical attention no matter how minor the injury appears.
- The hydraulic system may contain stored energy. Before performing maintenance or repairs on the hydraulic system, remove any attachments, engage the parking brake, disengage the weight transfer system (if equipped), shut off the engine, and remove the ignition key. To relieve pressure on the auxiliary hydraulic system, shut off the power unit engine and move the hydraulic control lever left and right before disconnecting the auxiliary hydraulic quick couplers.

SAFETY



KC220 Safety Procedures



- Setup the power unit and stump grinder so that particles are directed away from buildings or other objects of value.
- During the grinding process, objects can be thrown from the stump grinder causing injury or damage to people, animals, buildings, vehicles, or other objects of value. Use plywood or equivalent shielding to protect nearby buildings or objects.
- Keep bystanders away from the work area. Block access to the area prior to grinding stumps. Stop the stump grinder if anyone enters the work area.
- Stop grinding immediately if the cutter head strikes a rock or other solid object. Damage to the cutting teeth or the cutter head may occur.
- Do not operate with any of the cutting teeth missing. This causes the cutter head to become unbalanced and may cause damage to the stump grinder.

KC220 Additional Requirements for Personal Protective Equipment (PPE)

- Whenever you use this machine, wear a protective face screen to protect from flying wood chips and debris.

SAFETY

Safety Decals

The following safety decals must be maintained on your attachment.

Keep all safety decals legible. Remove all grease, dirt, and debris from safety decals and instructional labels. If any decals are faded, illegible, or missing, contact your dealer promptly for replacements.

When new components are installed, be sure that current safety decals are affixed to the replacement components.

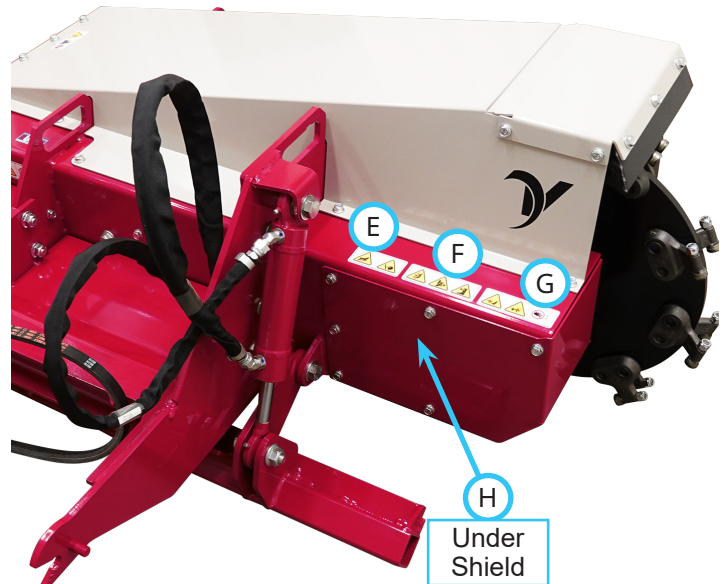
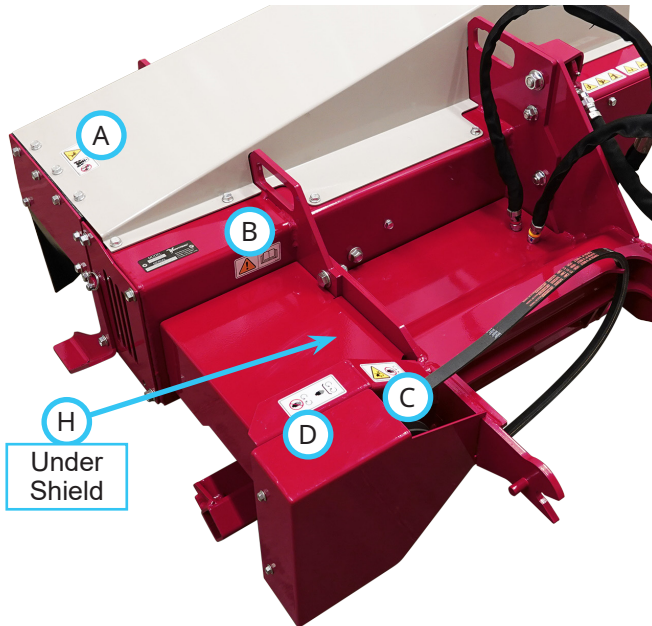

1. Thrown object hazard.
2. Keep bystanders away from the machine.

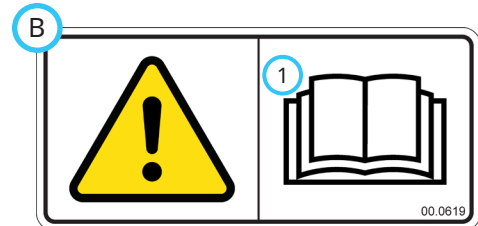

1. Read the operator's manual.



1. Finger or hand entanglement.
2. Stay away from moving parts.

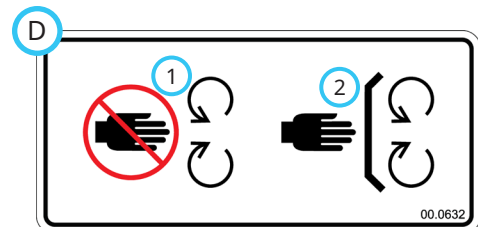

1. Stay away from moving parts.
2. Keep all guards and shields in place.

SAFETY



High pressure fluid hazard.

1. Keep body and hands away from suspected hydraulic leaks.
2. Wear eye protection when inspecting the hydraulic system for leaks.



1. Pinching or crushing hazard.

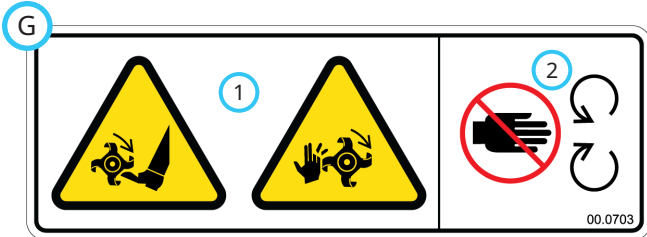

1. Cutting or dismemberment hazard of hand or foot - rotating tine.
2. Stay away from moving parts.

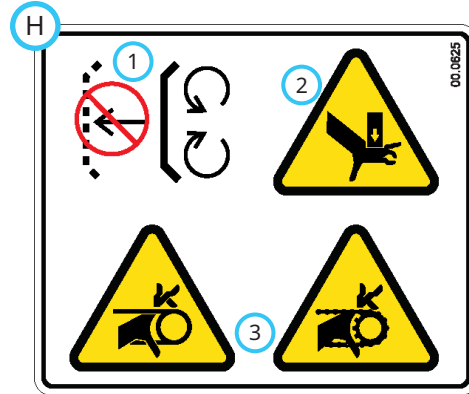

1. Shield missing - do not operate.
2. Pinching or crushing hazard.
3. Finger or hand entanglement.

Decal	Description	Part Number	Quantity
A	Thrown Objects Hazard	00.0674	1
B	Read Operator's Manual	00.0619	1
C	Finger/Hand Entanglement Hazard	00.0631	1
D	Moving Parts Hazard	00.0632	1
E	High Pressure Fluid Hazard	00.0621	1
F	Pinching or Crushing Hazard	00.0620	1
G	Cutting/Dismemberment Hazard	00.0703	1
H	Shield Missing	00.0625	2

OPERATIONAL CONTROLS

Primary SDLA Control Lever

The power unit's primary SDLA lever controls the depth of stump grinder. Pull the lever to the left to raise the stump grinder. Push the lever to the right to lower the stump grinder.

Secondary SDLA Control Lever

The power unit's secondary SDLA lever controls the blade/stand frame cylinder. The blade/stand frame is used to support the stump grinder when it is detached from the power unit. It can also be used as a blade to push wood chips and debris into the hole created when a stump is ground down. Pull the lever to the left to raise the blade/stand frame. Push the lever to the right to lower the blade/stand frame.

GENERAL OPERATION

Daily Inspection

⚠ WARNING

Always engage the parking brake, shut off the power unit engine, remove the ignition key, and ensure that all moving parts have come to a complete stop before inspecting the components, or attempting any repair or adjustment.

1. Park the machine on a level surface, with the engine shut off and all fluids cold.
2. Perform a visual inspection of both the power unit and the attachment. Look for loose or missing hardware, damaged components, or signs of wear.
3. Inspect the hydraulic hoses and the hydraulic fittings to ensure tight, leak free connections.
4. Inspect the belts for damage or excessive wear. Refer to the Belt Inspection section of this manual.
5. Inspect the cutting teeth for wear or damage and service as needed.

Attaching

1. Drive the power unit slowly forward into the hitch arms of the attachment. Align the lift arms of the power unit with the attachment hitch arms by raising or lowering the front hitch and complete the engagement.
2. Once completely engaged, move the front hitch latch lever* to the locked position. The latch (A) must lock over the attachment's hitch arm pin (B).
3. Engage the parking brake* and shut off the engine.
4. Place the attachment belt onto the PTO drive pulley on the power unit. Ensure the belt is properly seated in each pulley.
5. Engage the PTO belt tensioner rod.
6. Wipe the hose ends clean and connect to the power unit's hydraulic quick couplers. If equipped, connect the hoses and the quick couplers so the colored indicators are paired together (red to red, etc.).

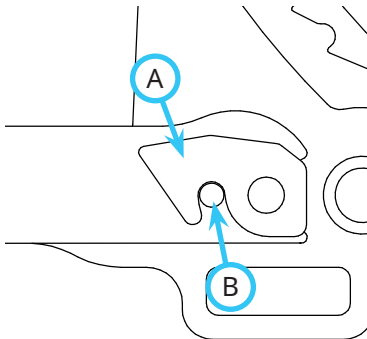

7. Start the power unit engine and slightly lift the stump grinder to remove the weight from the storage stands.
8. Remove the latch pin (C) that secures the left front stand and slide it up to the operating position. Reinstall the pin to secure in place.

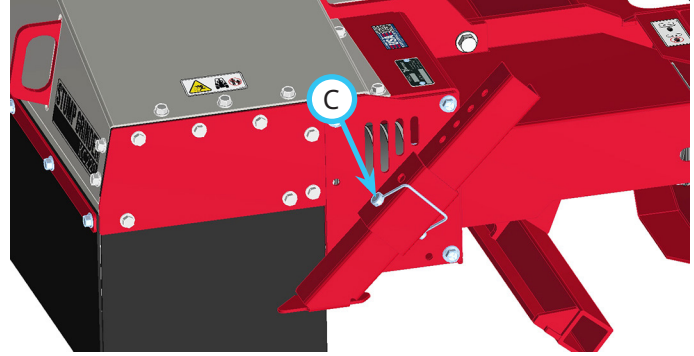

9. Raise the rear blade/stand frame using the secondary SDLA lever.

Detaching

1. Park the power unit on a level surface and engage the parking brake.*
2. Lower the rear blade/stand frame using the secondary SDLA lever.
3. Lower the attachment to the ground.
4. Remove the latch pin (C) that secures the left front stand and slide it down to the lowest position possible. Reinstall the pin to secure in place.
5. Shut off the power unit engine.
6. Disengage the PTO belt tensioner rod.
7. Remove the attachment belt from the PTO drive pulley of the power unit.
8. Disconnect the hydraulic quick couplers from the power unit and store the hose ends in the hitch frame holes on the attachment.
9. Disengage the front hitch locking lever.*
10. Restart the power unit and slowly back away from the attachment. A side to side movement of the steering wheel may aid in disengagement.

*Refer to power unit operator's manual for operation of power unit controls.

GENERAL OPERATION

Operating Procedure

Before operation, perform the daily inspection and set the power unit's high/low shift lever to low range.

Before grinding a stump, cut the stump as low to the ground as possible.

Move the stump grinder into position above the left edge of the stump. With the engine running between 2,000 and 2,500 RPM, engage the PTO switch, then adjust the throttle to the desired engine RPM.

Slowly lower the stump grinder until it begins to cut. Drive the power unit slowly forward and backward to move the stump grinder across the surface of the stump.

After each pass, lower the stump grinder and repeat the process. If the grinder is lowered too much at one time, the cutting process will be slow or the cutter head may stall. Raise the stump grinder slightly to continue.

Continue removing material until the corner of the rotor drive cover is approximately even with the top surface of the stump.

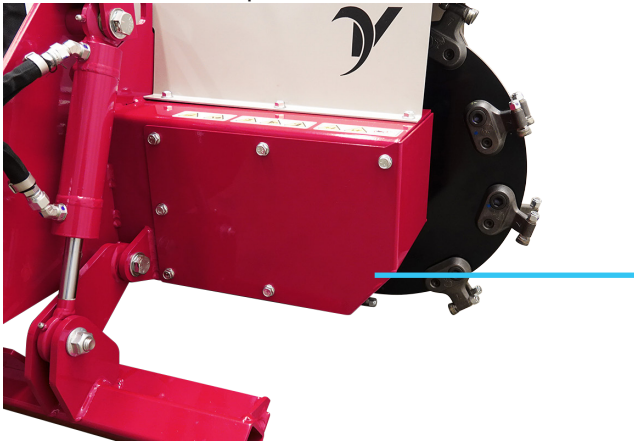

Raise the stump grinder and move to the right to position the stump grinder over the uncut edge of the stump. Continue cutting and repositioning until you reach the right side of the stump.

Return the stump grinder to the left side of the stump and repeat the previous processes to again cut from left to right across the stump until the stump is ground down into the ground.

Shut off the stump grinder and raise it out of the ground. You can now lower the blade/stand frame and use it to push the wood chips into the hole.

Transport of the Attachment

Transport the attachment with the power unit front hitch and attachment fully raised to reduce wear of the equipment. Travel slowly when transporting over undulating and rough surfaces to maintain control of the power unit and to reduce the shock to the power unit and the attachment. Always disengage the power unit PTO before transporting the attachment.

SERVICE

⚠ WARNING

Always engage the parking brake, shut off the power unit engine, remove the ignition key, and ensure that all moving parts have come to a complete stop before inspecting the components, or attempting any repair or adjustment.

ATTENTION

If any component requires replacement, use only original Ventrac replacement parts.

Cleaning and General Maintenance

For best results, and to maintain the finish of the stump grinder, clean or wash the stump grinder to remove accumulated wood chips, debris, and dirt after the job is finished.

Belt Inspection

Inspecting the drive belts of the attachment can prevent sudden belt failure by finding problems before they cause a belt to break.

Typical wear on a drive belt may result in the conditions shown in the diagram. If any of these conditions occur, the drive belt will require replacement.

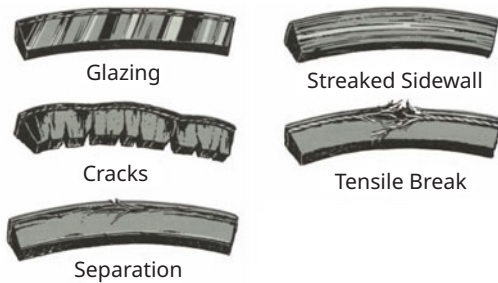

Attachment Belt Replacement

1. Detach the stump grinder from the power unit.
2. Remove the attachment belt cover (A).
3. Remove the old attachment belt and place the new attachment belt onto the pulley.
4. Reinstall the attachment belt cover and torque the bolts to 11 Nm (100 in-lbs).

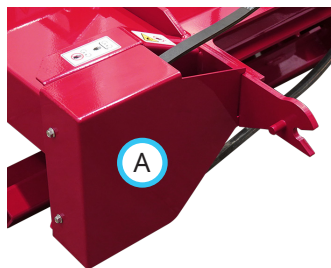

Rotor Drive Belt Replacement

1. Remove the rotor drive cover (A).

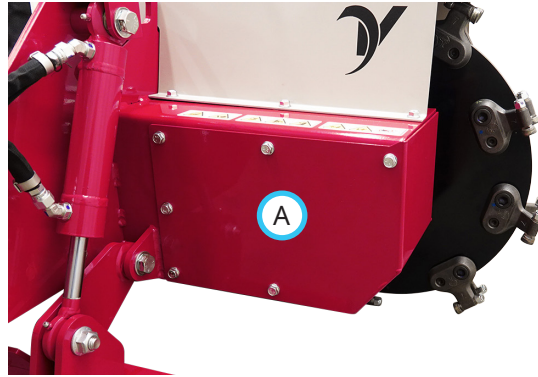

2. Remove the three mounting bolts (B) that fasten the front of the main cover (C) to the main frame.

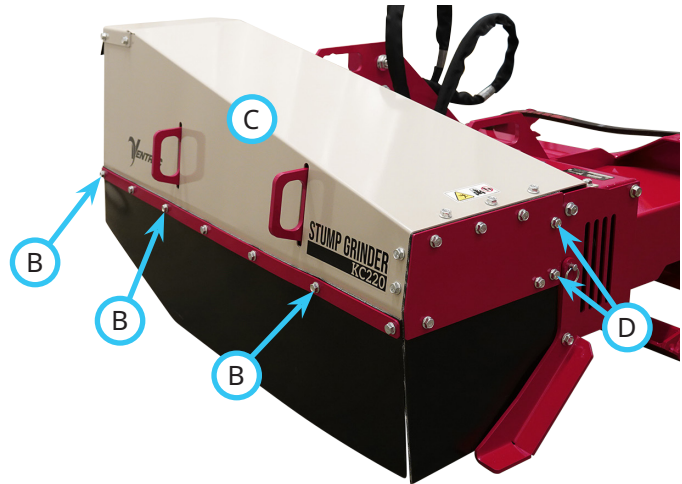

3. Remove the two mounting bolts (D) on the end of the cover.
4. Remove the seven mounting bolts (E) on the rear flange of the cover and remove the main cover from the stump grinder.

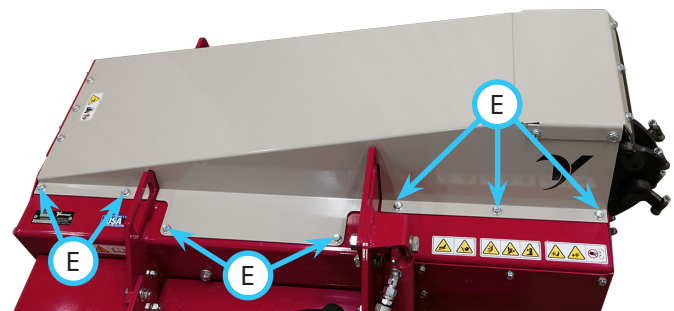

SERVICE

5. Remove the front drive pulley cover (F).

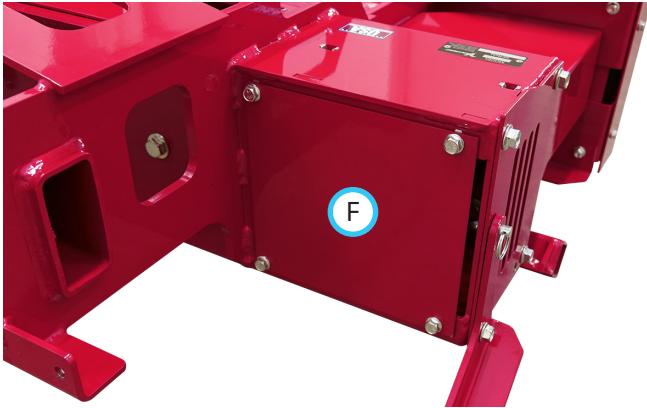

6. Remove the drive belt cover (G).



7. Disengage the rotor belt tensioning springs.
8. Remove the old drive belts and install the new drive belts onto the pulleys. Replace all four drive belts at the same time. NOTE: due to manufacturing tolerances on the belt length, if possible, choose four belts that are closest in length to each other.
9. Engage both rotor drive belt tensioning springs.
10. Reinstall the drive belt cover (G). Torque the bolts to 24 Nm (210 in-lbs).
11. Reinstall the front drive pulley cover (F). Torque the bolts to 24 Nm (210 in-lbs).
12. Reinstall the main cover (C) onto the stump grinder. Torque the bolts to 24 Nm (210 in-lbs).
13. Reinstall the rotor drive cover (A). Torque the bolts to 24 Nm (210 in-lbs).

Cutting Teeth Rotation or Replacement

The cutting teeth are indexed with three positions so that you can rotate them twice, exposing a new sharp edge before sharpening or replacing the tooth.

1. To rotate a tooth, loosen the nut (A) securing the tooth (B) and push the tooth away from the tooth mount.
2. Rotate the tooth one third of a turn to bring a sharp edge to the outside cutting position and torque the nut securing the tooth to 27 Nm (20 ft-lbs).
3. To replace a tooth, remove the nut securing the tooth and push the tooth out of the tooth mount.
4. Install the new tooth (B) and secure with a spacer (C) and nut (A). Torque the nut to 27 Nm (20 ft-lbs).

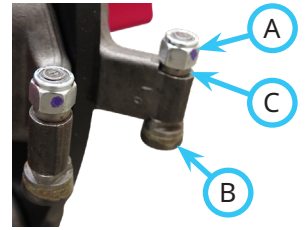

SERVICE

Lubrication Locations

Lubrication is required at the following locations using a lithium complex NLGI #2 grease.

Wipe the grease fittings clean before applying grease to the grease fittings.

Refer to the maintenance schedule for service intervals and the amount of grease.

1. Remove the drive shaft cover and grease the drive shaft bearings. Reinstall the cover and torque the bolts to 24 Nm (210 in-lbs).

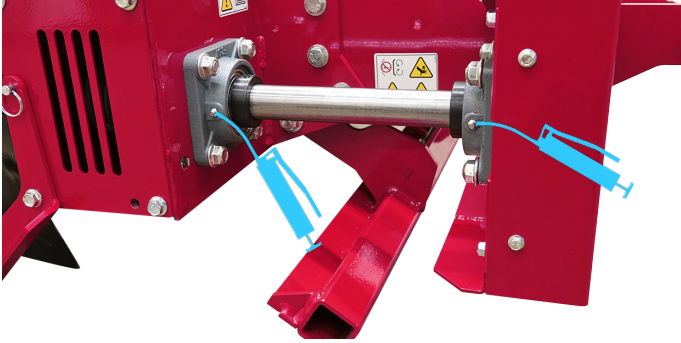

2. Remove the rotor drive cover and grease the rotor shaft bearings. Reinstall the cover and torque the bolts to 24 Nm (210 in-lbs).

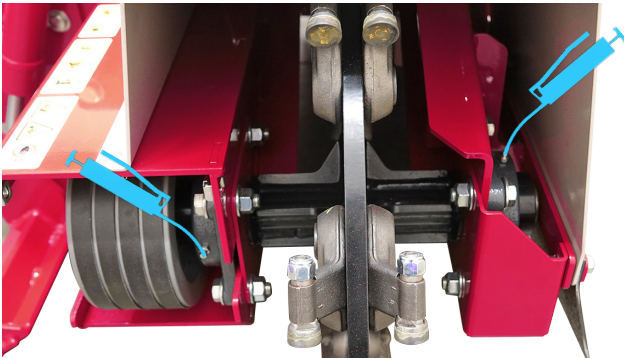

3. Grease the cylinder ends and the blade/stand frame pivots.

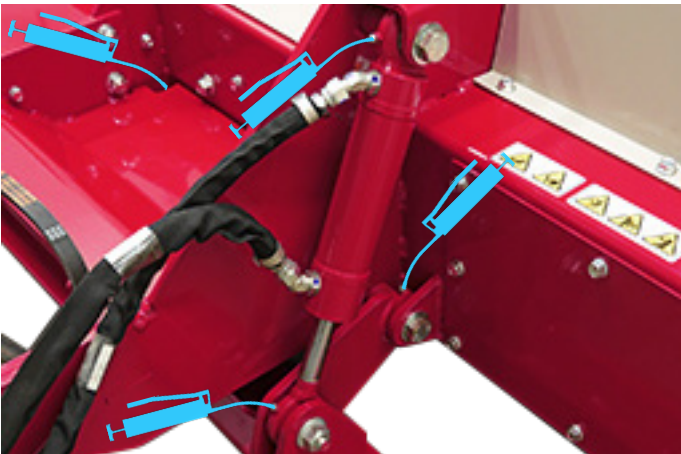

Storage

Preparing the Attachment for Storage

1. Clean the attachment to remove accumulated wood chips, debris, and dirt.
2. Inspect for loose or missing hardware, damaged components, or signs of wear. Repair or replace any damaged or worn components.
3. Inspect the hydraulic hoses and the hydraulic fittings to ensure tight, leak free connections.
4. Inspect the belts for damage or excessive wear.
5. Inspect the cutting teeth for wear or damage and service as needed.
6. Inspect the safety decals. Replace any decals that are faded, illegible, or missing.
7. Apply grease to all grease points and wipe off any excess grease.
8. Inspect the painted components for chips, scratches, or rust. Clean and touch up the surfaces as needed.

Removing the Attachment from Storage

1. Clean the attachment to remove any accumulated dust or debris.
2. Inspect the attachment as instructed in the Daily Inspection section of this manual.
3. Test the attachment to ensure that all the components are working properly.

SERVICE

Maintenance Schedule

	# of locations	# of pumps	As Needed	Daily	At 50 hours	At 100 hours	At 150 hours	At 200 hours	At 250 hours	At 300 hours	At 350 hours	At 400 hours	At 450 hours	At 500 hours	At 550 hours	At 600 hours	At 650 hours	At 700 hours	At 750 hours	At 800 hours	At 850 hours	At 900 hours	At 950 hours	At 1,000 hours	Yearly
Grease and Lubrication: See Lubrication Section																									
Drive Shaft Bearing	2	1			✓	✓	✓	✓	✓	✓	✓	✓	✓	✓	✓	✓	✓	✓	✓	✓	✓	✓	✓	✓	✓
Rotor Shaft Bearing	2	1			✓	✓	✓	✓	✓	✓	✓	✓	✓	✓	✓	✓	✓	✓	✓	✓	✓	✓	✓	✓	✓
Cylinder End	2	^			✓	✓	✓	✓	✓	✓	✓	✓	✓	✓	✓	✓	✓	✓	✓	✓	✓	✓	✓	✓	✓
Blade/Stand Frame Pivot	2	^			✓	✓	✓	✓	✓	✓	✓	✓	✓	✓	✓	✓	✓	✓	✓	✓	✓	✓	✓	✓	✓
Inspection																									
Inspect for Loose, Missing, or Worn Components				✓																					
Inspect the Belts and Pulleys				✓																					
Inspect the Hydraulic Hoses and Fittings				✓																					
Inspect the Cutting Teeth				✓																					
Inspect the Safety Decals				✓																					
^Grease until fresh grease is visible.																									

Maintenance Checklist

	# of locations	# of pumps	As Needed	Daily	At 50 hours	At 100 hours	At 150 hours	At 200 hours	At 250 hours	At 300 hours	At 350 hours	At 400 hours	At 450 hours	At 500 hours	At 550 hours	At 600 hours	At 650 hours	At 700 hours	At 750 hours	At 800 hours	At 850 hours	At 900 hours	At 950 hours	At 1,000 hours	Yearly
Grease and Lubrication: See Lubrication Section																									
Drive Shaft Bearing	2	1																							
Rotor Shaft Bearing	2	1																							
Cylinder End	2	^																							
Blade/Stand Frame Pivot	2	^																							
Inspection																									
Inspect for Loose, Missing, or Worn Components																									
Inspect the Belts and Pulleys																									
Inspect the Hydraulic Hoses and Fittings																									
Inspect the Cutting Teeth																									
Inspect the Safety Decals																									
^Grease until fresh grease is visible.																									

SPECIFICATIONS

Dimensions

Overall Height	58.4 cm (23 inches)
Overall Length	104 cm (41 inches)
Overall Width	129.5 cm (51 inches)
Cutter Head Width	9 cm (3.5 inches)
Cutter Head Diameter	56 cm (22 inches)
Cutter Head Speed	1,300 RPM
Cutting Depth Below Ground Level.	20.3 cm (8 inches)
Weight	190.5 kg (420 pounds)

Features

- 18 carbide teeth (rotatable and replaceable)
- Offset cutter head provides visibility of operation